

Name: Sani Daher

Date of Degree: July, 1996

Institution: Oklahoma State University

Location: Stillwater, Oklahoma

Title of Study: INTEGRATING A GROUND LOOP
HEAT EXCHANGER MODEL
INTO A BUILDING SIMULATION
PROGRAM

Pages in Study: 214
Degree of Master of Science

Candidate for the

Major Field: Mechanical Engineering

Scope and Method of Study: The purpose of this project was to integrate the ground loop heat exchanger model used in the ground loop heat exchanger simulation software (GLHEPRO) into the water loop heat pump system model of the Building Loads Analysis and System Thermodynamics (BLAST) software. BLAST is a comprehensive building simulation program used for the calculation of building loads and the design

of building environmental systems. The new feature added to BLAST gives the BLAST user the ability to size and simulate a wide variety of borehole configurations. The methodology used involves iteration between the ground loop heat exchanger model and the water loop model until the monthly temperatures of the loop from both models match. This iteration procedure is performed for one year at a time for up to a 25 year period. This gives the user the ability to study system performance over the long term. The key assumption of this methodology is that the ground loop temperature is essentially constant over a month. To test this methodology, two fictitious and one real building were simulated under a variety of conditions. The simulations were designed to validate the model and its implementation.

Findings and Conclusions : Through the simulations carried out using the three different buildings, the existing water loop and heat pump models of BLAST and GLHEPRO were validated. It was also verified that the new code produced results that were in good agreement with the ones from two other methods of simulation which use the

GLHEPRO and BLAST models separately. Simulations with the real building demonstrated that only this new code provides accurate reports about the unmet loads due to heat build up in the ground. Finally a brief comparison between the ground loop heat pump system economics and the dual duct variable air volume system economics outlines the savings realized by using a ground loop heat pump system as compared to other conventional systems.

ADVISER'S APPROVAL:

INTEGRATING A GROUND LOOP HEAT
EXCHANGER MODEL INTO
A BUILDING SIMULATION
PROGRAM

BY

SANI WASSEF DAHER

Bachelor of Science

Oklahoma State University

Stillwater, Oklahoma

1994

Submitted to the Faculty of the
Graduate College of the
Oklahoma State University
in partial fulfillment of
the requirements for
the degree of
MASTER OF SCIENCE
JULY, 1996
INTEGRATING A GROUND LOOP HEAT
EXCHANGER MODEL INTO
A BUILDING SIMULATION
PROGRAM

Thesis Approved:

Thesis Adviser

Dean of the Graduate College

ACKNOWLEDGEMENTS

I would like to express my deep appreciation to my advisor Dr. Jeffrey Spitler for his intelligent guidance, advice, and support. I would also like to thank the BLAST office at University of Illinois at Urbana Champaign, especially Dr. Richard Liesen and Dr. Dan Fisher, for all their help. Many thanks also go to Dr. Afshin Ghajar and Dr. Ronald Delahoussaye for serving as members of my advisory committee and providing valuable suggestions. This project has been funded by the Department of Energy and the Department of Defense. Their financial support is sincerely appreciated. I also owe a deep sense of gratitude to my wonderful colleagues in the HVAC research group, to the rest of my college professors, and to my host family the Hardins. Finally I extend special thanks to my parents Wassef and Nahi, and all my family members for all their love, support and patience. This thesis is dedicated to my parents.

TABLE OF CONTENTS

Section	Page
1. Introduction	1
1.1 Overview.....	1
1.2 Literature Review and Background	2
1.2.1 An Overview of Ground Loop Heat Exchangers.....	2
1.2.2 Ground Loop Heat Exchanger Models	3
1.2.2.1 Line Source Model	3
1.2.2.2 Cylindrical Source Model	5
1.2.2.3 Eskilson's Model	6
1.2.2.4 Comparative Discussion	8
1.2.3 The GLHEPRO Software	9
1.2.4 The Water Loop Heat Pump System	12
1.2.5 Water Loop Heat Pump System Model	14
1.2.5.1 The Loop Model	14
1.2.5.2 Heat Pump Model	15
1.2.5.3 Central Plant	17
1.2.6 Water Loop Heat Pump File Used in BLAST	17
1.3 Objectives.....	18
2 Methodology and Implementation	19
2.1 Methodology	19
2.2 Modifications in the BLAST and GLHEPRO Codes	22
2.3 Testing the Modified Code	25
2.3.1 BLAST input file WLHPTEST.blin	25
2.3.2 Discussion of the WLHPTEST results	26
3 Results and Discussion	29
3.1 Validation of Model	29
3.1.1 The Building Model in BLAST	29
3.1.2 Validation of the Heat Pump Models	30
3.1.2.1 Calculation of Heat Pump Performance Parameters	31
3.1.2.2 Comparing the Heat Pump Models of BLAST and GLHEPRO	33
3.1.3 Validation of the Water Loop Models	34
3.2 Three Methods for Simulating Ground Loop Heat Pump Systems	36

Section	Page
3.2.1 Comparing the New Model of BLAST with the Model of GLHEPRO.....	36
3.2.2 Comparing the GLHEPRO Model with the Simple Constant Loads Model	38
3.2.3 A Summary of All Three Methods of Simulation	40
3.3 A Sample Problem	42
3.3.1 The Design Process	42
3.3.1.1 Building Description in BLAST	44
3.2.1.2 Water Loop Heat Pump Description in BLAST	47
3.3.2.3 Ground Loop Heat Exchanger Description in GLHEPRO	54
3.3.2 Results for a One Year Simulation	57
3.3.3 Studying Long Term Effects	60
3.3.4 Comparing the New BLAST Model Results with the Results from the Simple Constant Loads Model	62
3.3.5 Comparing the Ground Loop System with a Dual Duct VAV System.....	63
4 Conclusions and Recommendations	68
4.1 Summary and Conclusions	68
4.2 Recommendations	69
References	71
APPENDIXES	72
APPENDIX A. - STRUCTURAL DETAILS OF THE WATER LOOP HEAT PUMP SYSTEM SUBROUTINE	73
APPENDIX B. - DETAILED EXPLANATION OF ALL CHANGES MADE IN THE CODE	86
APPENDIX C - A SUMMARY OF THE MANUAL ITERATIONS PERFORMED TO TEST THE METHODOLOGY	108
APPENDIX D.1 INPUT AND OUTPUT FILES OF THE INSULATED ONE ZONE BUILDING	113
APPENDIX D.2 CALCULATING BLAST HEAT PUMP PERFORMANCE COEFFICIENTS	128

Section	Page
APPENDIX D.3 COMPARING BLAST AND GLHEPRO WATER LOOP AND HEAT PUMP MODELS	130
APPENDIX E.1 COPY OF ONE OF THE DAYCARE CENTER BLUE PRINTS	133
APPENDIX E.2 BLAST INPUT FILE OF THE DAYCARE CENTER	135
APPENDIX E.3 TABLES OF THE DAYCARE CENTER LOADS ON THE HEAT PUMPS	146
APPENDIX E.4 PSYCHROMETRIC CHARTS USED IN THE SELECTION OF THE DAYCARE CENTER HEAT PUMPS	156
APPENDIX E.5 BLAST OUTPUT FILE OF THE DAYCARE CENTER USING THE ORIGINAL CODE	161
APPENDIX E.6 GLHEPRO INPUT FILE FOR THE DAYCARE CENTER	180
APPENDIX E.7 BLAST AND GLHEPRO OUTPUT FILES FOR THE DAYCARE CENTER FOR A TEN YEAR SIMULATION USING THE MODIFIED CODE	183

LIST OF TABLES

Table	Page
1.1 Comparison Between the Different Ground Heat Exchanger Models	8
3.1 Daycare Center Internal Loads	46
3.2 Daycare Center Peak Loads	48
3.3 A Summary of Heat Pumps Chosen	51
3.4 A Summary of the Simulation Results for the Fan System Alone	52
3.5 GLHEPRO Model's Sensitivity to Soil and Borehole Parameters	57
3.6 A Summary of the Results for a One Year Simulation of the Daycare Center Using the New Code	58
3.7 A Summary of the Results for a Ten Year Simulation	61
3.8 Parameters Used in the Design of the Dual Duct VAV System	64
3.9 A Summary of the Dual Duct System Results	64

LIST OF FIGURES

Figure	Page
1.1 Closed Loop Vertical Borehole	3
1.2 Flow Chart of the GLHEPRO Operation	10
1.3 Water Loop Heat Pump System	13
1.4 Water Loop	14
2.1 Flow Chart of the Proposed Iteration Loop	20
2.2 A Chart Outlining the Interaction Between the Modified Files	24
2.3 Manual Iterations Converging on the Second Iteration	27
3.1 Comparing Heat Pump Models with GLHEPRO using the Linear Fit	33
3.2 Comparing Heat Pump Models with GLHEPRO using the Quadratic Fit	34
3.3 Difference Between the BLAST and GLHEPRO Models	35
3.4 Comparing the BLAST and GLHEPRO Models	37
3.5 Comparing the GLHEPRO Model with the Constant loads Model	39
3.6 Comparing All Three Methods of Simulation	41
3.7 Daycare Center	44
3.8 Occupied Control Profile	46
3.9 Unoccupied Control Profile	47
3.10 Daycare Center EWT of the Ground Loop For the First Year	58
3.11 Heat Build Up Over a Ten Year Period for the Daycare Center	60
3.12 Comparing EWT for the Daycare Center Using Two Methods of Simulation.....	63
3.13 Yearly Energy Consumption	66
3.14 Yearly Operating Cost	67

1. Introduction

1.1 Overview

The oil crisis in the early 70's initiated the interest of many countries in researching alternative energy sources. Heat pumps at the time were already widely used for domestic heating and air conditioning in Sweden and to a certain extent in the United States and other parts of the world. Ambient air was used as the low-temperature heat source or sink required by the heat pump. The problem with this type of heat source or sink is that it follows climatic variation. The efficiency of such a system drops as the temperature approaches the freezing point in the heating mode, or high temperatures above 100 °F while in the cooling mode.

The ground in that sense is a more attractive heat source, or sink. Its temperature below a few meters depth is essentially constant. Using vertical ground loop heat exchangers referred to as boreholes, heat is rejected or absorbed from the ground. The design and sizing of these boreholes have been studied carefully by researchers at Lund University in Sweden (Eskilson 1987). Based on their mathematical model of boreholes, researchers at Oklahoma State University developed a user friendly software program GLHEPRO that sizes and simulates ground loop systems (Marshall and Spitler 1994).

Water loop heat pump systems have been in use for more than 40 years now. They quickly gained popularity due to their low cost and energy efficient means for air conditioning. Increasing demand for such systems gave the BLAST support office at the University of Illinois at Urbana Champaign the incentive to add the water loop heat pump system to the BLAST software (Lash 1992). In BLAST the user may use a boiler and a chiller as a plant to serve the water loop fan system. The objective of this project was to add the ground loop simulation part of the GLHEPRO software to BLAST as another possible “plant” (heat source/ sink) for the water loop system. This new system is referred to as the ground loop heat pump system. It gives the BLAST user the ability to simulate a wide variety of ground source heat exchangers for long periods of

time, up to 25 years. This allows the user to study the long term effects of using the boreholes under specific building loads.

1.2 Literature Review and Background

1.2.1 An Overview of Ground Loop Heat Exchangers

The depth of a typical borehole is between 100 to 450 feet deep with a diameter between 3 to 6 inches. Typical fluid temperatures within the borehole tubes run between 30 °F and 100 °F. Heat extraction or rejection between the heat exchanger and the surroundings takes place by pure heat conduction. The heat exchanger (See figure 3.1), studied here is the closed loop formed in a U-shape. It is the most common and has the advantage that heat extraction may take place even at temperatures below 32°F if an antifreeze mixture is used. After the exchanger is installed the rest of the space in the borehole is filled again, usually with grout. The grout maintains a good thermal contact between the borehole wall and the pipes.

One problem that designers are faced with is finding a good estimate of the soil parameters such as the thermal resistance, capacity etc. Geological data provides a large range for each of these parameters. Usually the average value of these parameters is used in simulations. Even then the error might be significant. To get more accurate results using any of the models in section (1.2.2), experimental methods of computing the site soil properties are needed.

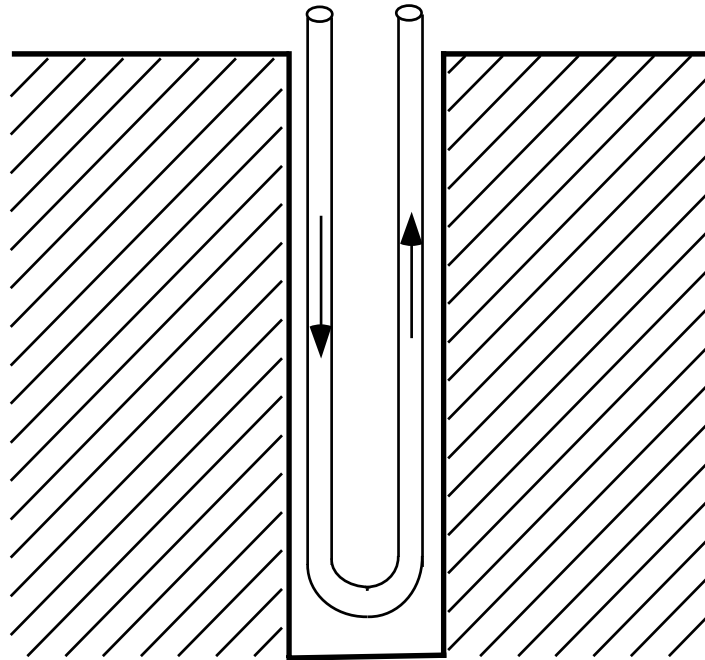

Figure 1.1 Closed loop vertical borehole

1.2.2 Ground Loop Heat Exchanger Models

The most significant ground loop heat exchanger models published are the line source model, the cylindrical source model, and Eskilson's model. In the next sections, a brief description and discussion of all three models is presented. All three models describe vertical-U-tube type ground heat exchanger as described in the above section. In the discussion of the three models, the end effects of the heat exchanger, the interaction between multiple boreholes and the modeling of the U-Tube heat exchanger are emphasized. A comparison between the three models based mainly on these points follows.

1.2.2.1 Line Source Model

The Kelvin heat-source theory is based on an infinitely long permanent line source of heat, with a constant rate of heat rejection on an infinite medium at an initial uniform temperature of T_0 . Heat transfer between the borehole and soil is carried out by pure radial heat conduction for a perfect soil, borehole contact. Soil properties are considered constant and homogeneous. Ground water

movement is not considered in the model. The temperature at any point in the medium is given by the following equation (Ingersoll, Zobel, Ingersoll 1954):

$$T-T_o = \left(\frac{\dot{Q}}{2kpi}\right) * \int_x^\infty \frac{1}{B} e^{-B^2} dB \quad (1.1)$$

where

T = Temperature in soil at any selected distance from the pipe.

T_o = Initial temperature of soil.

\dot{Q} = Heat rejection from the pipe to ground.

r = Distance from the pipe center line.

k = Thermal conductivity of the soil.

t = Time since the start of operations.

B = Variable of integration.

The integral is evaluated between X and infinity, where $X = (r/2\sqrt{\alpha t})$ (1.2)

α = Thermal diffusivity of soil.

ρ = Density.

c = Specific heat.

Equation (1.1) mathematically defines the earth undisturbed temperature at a given radius. When \dot{Q} is non-zero, the equation may be used to determine the change in temperature of the soil contacting the borehole after a given time of operation. Note the this equation is applicable to both single and multiple horizontal and vertical heat exchangers and can be used to determine the thermal interference between boreholes in close proximity (Bose, 1984). The solution from each borehole is superimposed to get the multiple boreholes solution.

One disadvantage of this model is that it does not consider the end effects of the borehole. The heat conduction is assumed to be radial only. For a long loop the assumption produces fairly

good results. Another approximation is the modeling of borehole internal structure (see section 1.2.1). It is modeled by an overall heat transfer coefficient, which is the reciprocal of the sum of the soil and pipes heat resistance. Finally notice that the line source model was developed based on a constant rate of heat transfer. For purposes of modeling the boreholes the heat transfer rate is averaged over each month and the integral in equation 1.1 is evaluated as the sum of integrals for each month.

1.2.2.2 Cylindrical Source Model

The same assumptions made for the line source model apply to the cylindrical model, with the exception of the borehole modeling. In the Cylindrical source model the borehole has a finite diameter. The U-shaped pipes diameter D is approximated by an equivalent diameter D_{eq} (Bose 1984) .

$$D_{eq} = \sqrt{2} D \quad (1.3)$$

The cylindrical source solution (Kavanaugh 1991) is the exact solution to a buried cylindrical pipe in an infinite medium. It can produce results for either a constant pipe surface temperature or a constant heat transfer rate. The solution yields a temperature difference between the outer cylindrical surface and the undisturbed far field soil temperature. Note that the line heat source model is a simplified variation of this solution. This method produces similar results if longer time intervals are used.

The cylindrical solution for a constant heat flux is as follows :

$$\Delta T_g = T_{ff} - T_{ro} = \left(\frac{Q_{gc}}{k_s L} \right) * G(z, p) \quad (1.4)$$

where

T_{ff} = Far field soil temperature.

T_{ro} = Outer cylindrical surface temperature.

Q_{gc} = Heat transfer rate between borehole and soil.

k_s = Thermal conductivity of the soil.

L = U- tube length.

$G(z,p)$ = Cylindrical source integral, z is the Fourier number, and p is the ratio R/R_o

R = Radius of a circle in the soil measured from the borehole center.

R_o = Radius of the borehole outer surface.

Equation 1.4 is further modified account for the fact that the heat flux is not constant. The solution may be divided into time intervals for the different heat rates. Then the solutions are superimposed, by adding the resulting temperature difference for each interval. Kavanaugh's model also accounts for the short circuiting of heat transfer that takes place between the two pipes of the borehole due to the temperature difference between them. However, like the line source model, it does not consider the end effects of the borehole. The model is based on an infinite borehole length. For more detailed derivation of this model's equations, the reader is referred to (Kavanaugh , 1991).

1.2.2.3 Eskilson's Model

Eskilson's model is based on the numerical solution for a finite line source. A numerical solution is used because the finite line source model has no simple analytical solution.

The mathematical equation governing the heat conduction is as follow :

$$\frac{1}{a} \frac{\partial^2 T}{\partial r^2} = \frac{\partial^2 T}{\partial r^2} + \frac{1}{r} \frac{\partial T}{\partial r} + \frac{\partial^2 T}{\partial z^2} \quad (1.5)$$

This model provides the most accurate results, since unlike the past two models, it considers the end effects of the boreholes. The numerical solution however requires a large amount of data and CPU time. For this reason Eskilson uses the "g- function method" which is an approximation to the numerical solution.

A specific g-function represent a specific borehole configuration response to a unit step change in heat extraction or rejection. The g-functions are computed using the finite difference solutions to the finite line source differential equation which are then superimposed. The term borehole configuration refers to the geometric arrangement of multiple boreholes. For example, nine boreholes in a square layout with a specific spacing between the boreholes is one configuration that has a unique g-function.

Eskilson models the internal borehole structure by an equivalent total thermal resistance. This resistance is the summation of three thermal resistances. One is between the two pipes that forms the ground loop. The other two are between each pipe and the borehole wall.

Eskilson's model accounts for the thermal interference between nearby boreholes (Young 1995). It also accounts for different building load profiles. The main drawbacks of this model are the limited number of borehole configurations and the change of the borehole field area every time the borehole depth is changed.

Another limitation imposed by Eskilson mathematical model is the time step. The response to variations for a time step less than two hours must include the transient response of the fluid, piping, and borehole. These short time effects were not considered in Eskilson model thus time steps less than two hours may not be used in this model. For more detailed information on the Eskilson method, the reader is referred to Eskilson (1987).

1.2.2.4 Comparative Discussion

This section summarizes the advantages and disadvantages of the three different models studied above. Ideally, a perfect model should be able to account for everything included in Table 1.1, and more. It should be able to predict the effects of equipment cycling on and off, and changes in borehole and fluid properties and their effects on the performance of the ground heat exchanger for small time steps.

The model should also be able to account for ground temperature seasonal changes, moisture content and water infiltration effects on the heat transfer rate between the borehole and the ground. However, it is mathematically challenging to include all these effects in one model, even with the aid of computers. Therefore the models used only include the most significant effects. Table 1.1 below has a summary of the different models with their advantages and disadvantages. From the table below, it is clear that Eskilson’s model has better capabilities than the other two.

TABLE 1.1 COMPARISON BETWEEN THE DIFFERENT GROUND HEAT EXCHANGER MODELS.

Model	Line Source	Cylindrical Source	Eskilson’s Model
Analytical Method	Line Source	Cylindrical Source	Numerical Solution
Accounts for borehole end effects.	No	No	Yes
Modeling of borehole internal structure	Borehole pipes modeled by an equivalent thermal resistance.	Borehole pipes approximated by an equivalent pipe diameter.	Borehole pipes modeled by an equivalent thermal resistance.
Accounts for thermal interference between boreholes	May be extended to do so	Yes	Yes
Accounts for thermal effect of grouting	No	Yes	Yes

1.2.3 The GLHEPRO Software

The GLHEPRO software, which is based on Eskilson’s methodology was developed at Oklahoma State University in 1994 (Marshall and Spitler, 1994). The code produces results that are in perfect agreement with Eskilson’s results (Spitler 1995). Note although Eskilson does not mention any comparison with experimental work in his thesis, his model is based on careful

numerical analysis of the differential equations describing the problem. Eskilson also compares his numerical solution for 100,000 ft boreholes with the analytical solution to infinite continuous line sources in a homogeneous medium for different borehole configurations. Each line source represents one borehole. The results agreed within 3 % maximum difference in ground loop temperatures. (Eskilson 1987).

GLHEPRO has the ability of performing two different tasks that aid the user in the design and analysis of ground loop heat exchangers. Through the GLHESIM feature the user may perform simulations of a specific ground loop to determine the monthly inlet, average and exiting fluid temperatures. It also calculates the power consumed by the heat pumps, and the heat extraction/rejection rate per unit depth. The GLHESIZE feature calculates the required borehole depth and total loop length such that the user specified minimum and maximum temperatures exiting the heat pump are not exceeded over the whole simulation period.

Figure 1.2 shows a flow chart of the GLHEPRO operation. After some software like BLAST is used to calculate the building loads, GLHEPRO can read the loads directly from the BLAST output file. The user then has to supply information about the system to be simulated. That includes information about the heat pumps, boreholes configuration including their depth, diameter, and all the soil parameters. The user can then use either simulation options GLHESIM, or GLHESIZE as discussed previously.

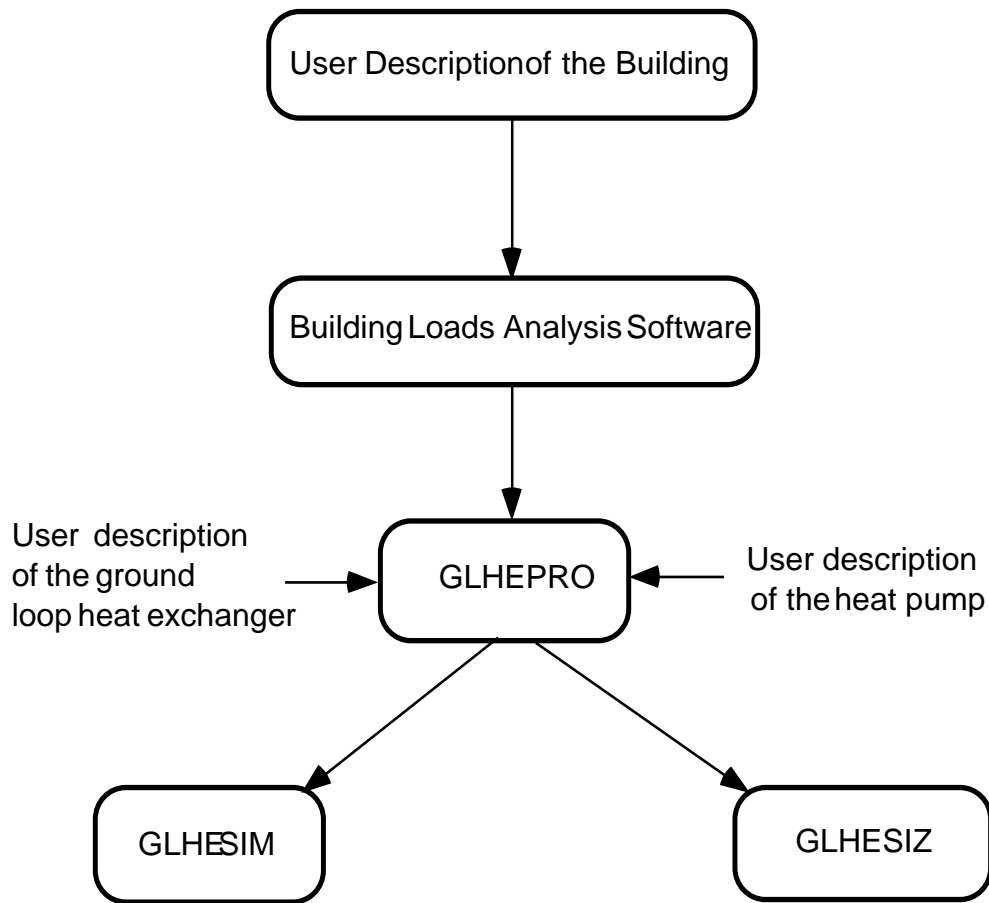

Figure 1.2 Flow Chart of the GLHEPRO Operation

The GLHEPRO software uses the g-functions to simulate a specific borehole configuration. This limits the user to a number of borehole configurations for which the g-functions have been pre-computed. Currently GLHEPRO has 185 different borehole configurations that the user can choose from. The size of the boreholes field can be changed, but the distance between boreholes is dependent on the boreholes depth. In other words the user can only specify the ratio of the boreholes depth to the distance between their centers. Another limitation of GLHEPRO and ground loop heat pump systems in general, is the allowable loop temperature. The ground loop temperature should be in the range that the heat pump can handle, typically between 35 °F and 110 °F.

The user of GLHEPRO or any other software for simulating ground loop heat pump systems should be aware of the ground loop model's sensitivity to soil and borehole parameters. Soil parameters such as conductivity, thermal capacity, undisturbed ground temperature, and borehole thermal resistance may affect the loop temperatures and thus the loop size considerably. Therefore it is very important to use the most accurate values available for these parameters.

Unfortunately precise data on some of these parameters is not available. For example the range of conductivity for Granite rocks in literature may be listed as a range between 2.1 BTU/hr.ft.°F and 4.5 BTU/hr.ft.°F (EPRI 1989). That is more than a 100 % change. Note using the lower value of conductivity does not solve the problem. The ground loop might then be over designed, resulting in a ground loop system that is more expensive than conventional systems. In chapter 3, the effect of varying these parameters on the ground loop temperature for the daycare center sample problem is illustrated in table 3.5. It is recommended that soil parameters be determined experimentally in the absence of precise information.

The main objective of this thesis is to integrate the subroutines used in the GLHESIM simulation option with the water loop subroutine in BLAST. GLHESIM calculates a set of inlet, average, and outlet fluid temperatures given the loads on the loop for that year. In the previous section it was mentioned that the time step used with Eskilson's mathematical model cannot be less than two hours. In GLHESIM daily simulations takes place. The loads and temperatures are then averaged over each month. So basically, if GLHESIM is given a set of twelve monthly heating and cooling loads, it produces a set of twelve monthly fluid temperatures. The set includes the ground loop entering, exiting and average loop temperatures.

1.2.4 The Water Loop Heat Pump System

In this section the water loop model used in the BLAST software is presented with emphasis on the parts that directly relate to the integration process. For more information on this model the reader is referred to Lash (1992).

There are three subsystems in the water loop heat pump system. These subsystems include the heat pump network, the water pump, and the ventilation system as seen in figure 1.3. Since the ground loop, which acts as the plant, only affects the water loop, our concentration will be focused on it rather than on the ventilation system.

In the water loop each heat pump unit acts independently of each other to control the temperature in each zone. So each heat pump rejects or absorbs heat from the water loop depending on the temperature of that zone. This independent operation allows for energy savings by balancing the heat demand from different zones of the building. For example, a zone might be rejecting heat, while another is absorbing some. Since they are both rejecting or absorbing from the same source, these loads balance out and only the difference is supplied by the plant.

Usually the loop is kept between 60 °F and 90°F by the plant. However if used with a ground loop, the temperature variation may be a bit larger. Some of those systems use a thermal storage tank. The tank preserves hot water from the morning and afternoon hours to be used during the night for the relatively colder hours. However, in the cases where you have a ground loop, such thermal storage is not needed, since the ground loop acts like one in a way.

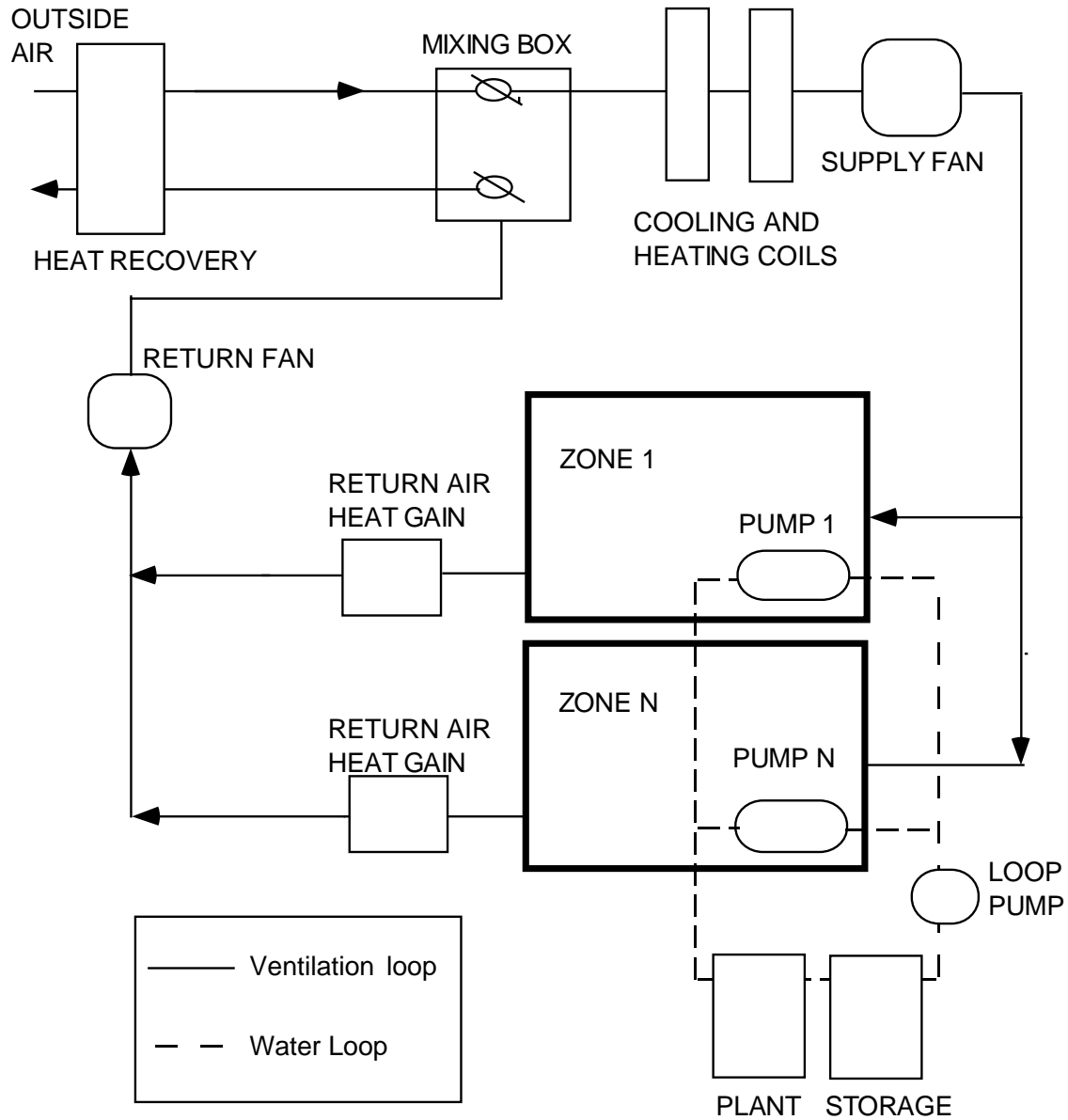

Figure 1.3 Water Loop Heat Pump System

1.2.5 Water Loop Heat Pump System Model

This section explores the water loop model used in BLAST as described by Lash (1992). The water loop model as in figure 1.4, consists mainly of three subsystems, the loop, the heat pump

network and the central plant unit. The next three sections describes the models of these systems.

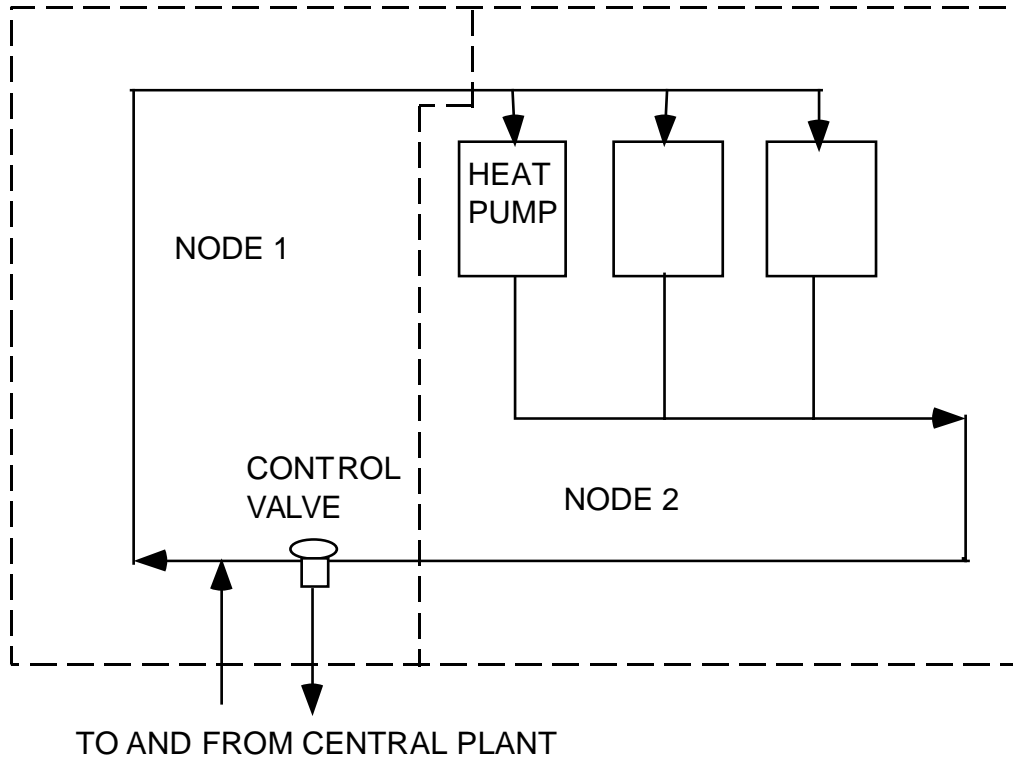

FIGURE 1.4 WATER LOOP

1.2.5.1 The Loop Model

The loop is divided into two sections or nodes as in figure 1.4. Node 1 includes the mass of the water between the central plant and the first heat pump which is assumed to have a uniform temperature. Node 2 consists of all the water mass from the exit of the heat pumps to the central plant. The performance of the loop is mathematically described with the following coupled differential equations :

For Node1 :

$$M_1 c_p \left(\frac{dT_1}{dt} \right) = \dot{m} c_p (T_2 - T_1) + Q_{plant} \quad (1.6)$$

For Node 2 :

$$M_2 c_p \left(\frac{dT_2}{dt} \right) = \dot{m} c_p (T_2 - T_1) + Q_{pumps} \quad (1.7)$$

where

T_1 = Water temperature of node 1 (°C)

T_2 = Water temperature of node 2 (°C)

M_1 = Water mass in node 1 (kg)

M_2 = Water mass in node 2 (kg)

c_p = Specific heat of water (kJ/kg °C)

\dot{m} = Mass flow rate of water in the loop (kg/s)

Q_{plant} = Net heat added by the central plant (kW)

Q_{pumps} = Net heat added by all the heat pump units (kW)

The quasi-steady solution in terms of the node temperatures is presented in Lash (1992).

The software uses steps of one minute during which Q_{plant} and Q_{pumps} remain constant and are updated each time step.

1.2.5.2 Heat Pump Model

A heat pump is nothing but a refrigeration system that has the ability to use the heat rejected from the condenser as a heating source when needed. Thus heat pumps are capable of supplying either heating or cooling depending on whether heat is being rejected to a sink (cooling mode) or heat is being absorbed from a source (heating mode). In the water loop heat pump system, the water loop acts as both the heat source and sink. The heat pump performance can be characterized by the following equations :

Cooling mode :

$$\frac{Capacity}{BaseCap} = A_1 + B_1 \left[\frac{T_{loop}}{T_{ref}} \right] + C_1 \left[\frac{T_{ref}}{\dot{m}_{base}} \right] \left[\frac{\dot{m}}{T_{wb}} \right] \quad (1.8)$$

$$\frac{EER}{BaseEER} = D_1 + E_1 \left[\frac{T_{loop}}{T_{ref}} \right] + F_1 \left[\frac{T_{ref}}{\dot{m}_{base}} \right] \left[\frac{\dot{m}}{T_{wb}} \right] \quad (1.9)$$

Heating mode :

$$\frac{Capacity}{BaseCap} = A_2 + B_2 \left[\frac{T_{loop}}{T_{ref}} \right] + C_2 \left[\frac{T_{ref}}{\dot{m}_{base}} \right] \left[\frac{\dot{m}}{T_{db}} \right] \quad (1.10)$$

$$\frac{COP}{BaseCOP} = D_2 + E_2 \left[\frac{T_{loop}}{T_{ref}} \right] + F_2 \left[\frac{T_{ref}}{\dot{m}_{base}} \right] \left[\frac{\dot{m}}{T_{db}} \right] \quad (1.11)$$

where

$T_{ref} = 283 \text{ K or } 511 \text{ }^\circ\text{R}$

$T_{loop} = \text{The loop temperature (}^\circ\text{R or K)}$

$\dot{m}_{base} = \text{The rated mass flow per unit capacity multiplied by the base capacity.}$

$\dot{m} = \text{The mass flow rate of water through the heat pump.}$

$T_{db}, T_{wb} = \text{The dry bulb and wet bulb air temperatures. (}^\circ\text{R or K)}$

The base values, BaseCap, BaseEER, BaseCOP are determined by ARI standards or manufacturers design recommendations. For more details, see Lash, (1992).

1.2.5.3 Central Plant

A typical central plant for a water loop heat pump system consists of a boiler and a cooling tower. The plant is not connected directly to the closed water loop circuit, but a control valve

diverts flow to a high efficiency heat exchanger coupled with the proper central plant unit. In this thesis the “plant” will be the ground loop heat exchanger alone (See section 1.2.1). It is important to note that Q_{plant} as in Lash model is only dependent on the total mass flow rate through the water loop and the difference between the water temperature at node 1 and the water temperature exiting the heat pump network. (See figure 1.4) This monthly load is what the ground loop needs to reject or supply each month.

1.2.6 Water Loop Heat Pump File Used in BLAST

Since the heat exchanger model is to be integrated into the water loop heat pump system source code namely WLHPS.FTN, a good understanding of the WLHPS.FTN subroutines is essential. For this reason, a detailed explanation of all the steps and calculations that take place in the subroutines of that file is presented in Appendix A. Two major points that directly relate to the objectives of this thesis are summarized below.

The time step used in the simulation is one minute. When linking the two programs, the time step in both models should be the same. In BLAST, WLHPS is called once every hour, to run a minute by minute simulation for each hour. Hourly values of the heating and cooling loads, electric usage etc. are returned. The minute by minute simulation is necessary to calculate how often the heat pumps cycle ON and OFF.

The next point that is of importance is the loop temperature. When the ground loop is serving the water loop fan system, the temperature of the fluid exiting the ground loop should be equal to the plant water temperature, or the temperature of the water going into the heat pump network. There is a lag in time between the plant outlet temperature and the temperature seen at node 1 (See figure 1.4). However this lag in time does not exceed 3 hours for a realistic water loop system (Lash 1992).

Appendix A, or the BLAST manual (1993), show that there are mainly three ways that the plant outlet water temperature can be controlled by the user. The user could specify one constant

optimized temperature for the whole year, or some dead band temperatures (a maximum and a minimum) or hourly scheduled temperatures for the week. As it will be shown later, a monthly constant water temperature out of the plant is needed for linking the two programs. None of the available controls give monthly constant temperatures. Modifications to the WLHPS.FTN deck will be discussed in more details in chapter 2.

1.3 Objectives

The primary objective of this project is to add the ground loop simulation subroutines of GLHEPRO into the BLAST software, in such a way that it can be used as a plant for the water loop heat pump fan system. The BLAST user may then run simulations with the ground loop up to a 25 years period. This gives the user the ability to study the transient response or long term effects of any loads on the ground loop of his or her choice.

The other main objective of this thesis is to present in details the design procedure to be used with the modified water loop heat pump system. A daycare center is used as a sample problem to show the step by step design process of the ground loop heat pump system. The cost effectiveness of implementing a water loop heat pump system served by a ground loop, as compared to another fan system served by a boiler and a chiller is also investigated in this paper using the daycare center.

2 Methodology and Implementation

2.1 Methodology

In the introductory chapter, two important considerations were raised which are vital to successful implementation of the model. One, the time step of each program, and the second is the loop temperature. The first consideration is to make the two programs* communicate on the same time basis. GLHESIM runs monthly simulations, and BLAST runs hourly simulations. GLHESIM may be made to run hourly simulation, or BLAST may be made to run with the monthly results from GLHESIM. Note that the first solution means developing totally new mathematical models for the system, which would be way out of the scope of this project. However the second proposed solution may be implemented directly in an iterative fashion. Figure 2.1. shows the proposed iteration loop between the two programs.

Basically BLAST was modified to assume a set of monthly water loop temperatures coming from the plant for the first year. These monthly temperatures along with the heat pump network exiting water temperatures and the total flow rate are used to calculate the monthly loads on the plant. These loads are stored in the variable Q_{plants} discussed in section 1.2.5.3. The loads are then transferred to the simulation subroutine of GLHESIM to produce a set of monthly ground loop temperatures, by simulating the loop's ability to reject or absorb the monthly loads.

Then BLAST uses the exiting ground loop temperatures to calculate a new set of loads. These iterations will go on until the old and newly calculated temperatures match for the year simulated. The program then goes on to simulate the next year until all years are simulated. The results of the monthly entering, exiting and average ground loop temperatures and the heat rejection rate are printed to a special file called outfile. The BLAST output file remains the same with two exceptions.

* Actually, the program GLHESIM is converted to a subroutine, which is called by BLAST.

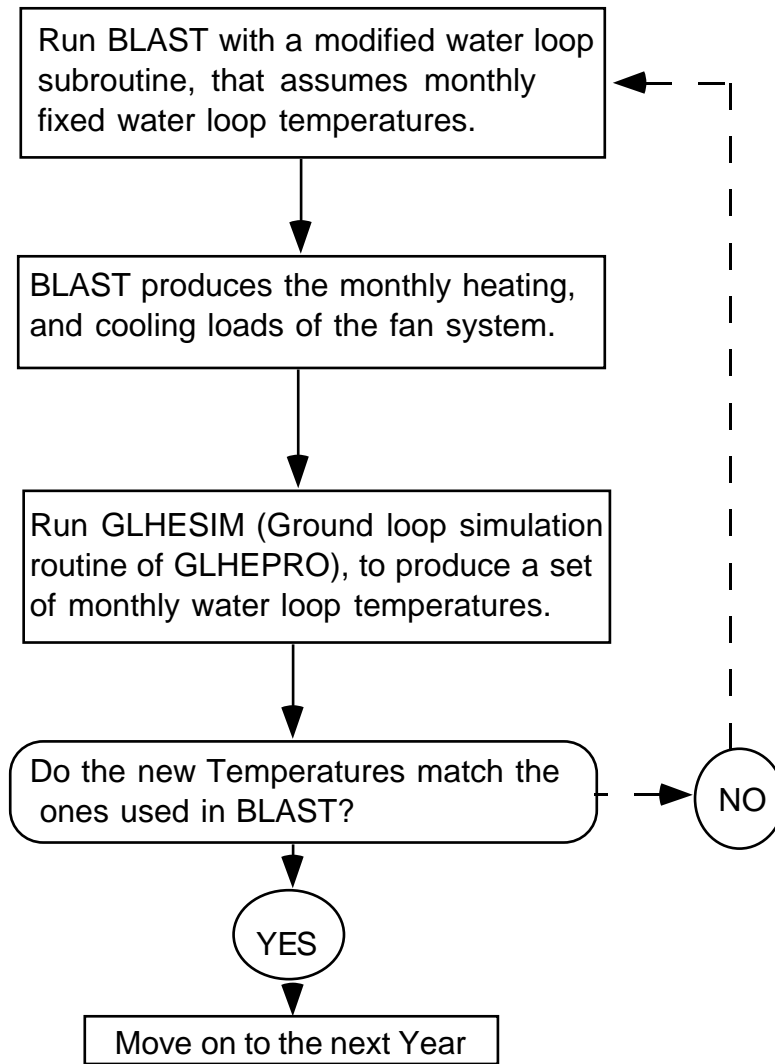

Figure 2.1 Flow Chart of the Proposed Iteration Loop

In the BLAST output, the section where the maximum and minimum monthly loop temperatures entering and exiting the heat pump network has been modified. The temperatures now reflect the maximum and minimum temperatures over as many years as were simulated. Also the unmet loads reflect the unmet loads for the last year of simulation. For example, if the user wanted to know the unmet loads for year five, then he or she has to run five years of simulation. The WLHPS report will reflect the results for the fifth year of simulation, with the exception of the maximum and minimum water temperatures entering and exiting the heat pump network. This way it is easier for the user to see the effect of heat build up in the ground on the performance of

the system. Note this is one of the main results that may not be realized with the old methods used. More about this in chapter 3.

Currently the exiting ground loop temperatures convergence criteria is set to 0.5 °F. This convergence criteria is acceptable for all practical purposes. The convergence criteria will be a user input, for which the default is 0.5 °F, the users may choose to raise or lower this value depending on the accuracy desired. However for a convergence criteria lower than 0.5 °F, the solution may take a long time to converge. For a building with highly unbalanced loads, the solution might even get stuck. For that reason a relaxation scheme was added to the program.

If the program passes the fourth iteration for any year, then chances are the solution is not converging and the relaxation scheme is automatically used to reach convergence. An example of this situation is given in chapter 3. It is recommended that the user uses the default convergence criteria of 0.5 °F. If the solution does not converge, then the user should try a larger convergence criteria, before using a bigger borehole. This issue is covered in more details in appendix B.

It is important to understand the meaning of the convergence criteria. If the convergence criteria was 0.5 °F, that means the heat pump performance was modeled with that accuracy built into the entering water loop temperatures. So it will not make much difference in the overall results, if the convergence criteria was 0.5 °F or 1.0 °F. For example, a 0.5 °F difference in the heat pump entering water temperature will only change the heat pump power consumption by 0.4 percent* . It is however important that the temperatures converge within a certain criteria so that the error may be estimated. The results in chapter 3 will show that a convergence criteria as high as 1.0 °F still produces excellent results for all practical purposes.

* Calculation performed for a Florida Heat pump SX030 at EWT of 60 °F and 5.5 G.P.M. flow rate.

2.2 Modifications in the BLAST and GLHEPRO Codes

The methodology is fairly simple, it is implementing and testing it that required all the time. In this section, all the changes made in the BLAST and GLHESIM to implement the methodology, are discussed in details. For conciseness, the modifications along with their detailed discussion are contained in Appendix B. The following paragraphs should give the reader an overall picture of the changes made and how they come together to implement the discussed methodology. The reader who is interested in further developing this code should definitely read through Appendix B, while studying the code.

There are six files from the BLAST and GLHEPRO programs that are modified to implement this methodology. The modified files from are REPORT.inc, BLD1.ftn, ROUT40.ftn, ROUT35.ftn, and WLHPS.ftn from the BLAST software, and GLHESIM from the GLHEPRO software. Figure 2.2 shows how these files interact with each other to implement the methodology.

The main changes in BLAST took place in the subroutine WLHPS.ftn and GLHESIM.ftn which was added to BLAST. WLHPS.ftn is the water loop heat pump system file. Recall that Appendix A has a detailed study of this subroutine. GLHESIM.ftn has the ground loop simulation subroutines. In addition to these modified files there are some files which are used by GLHESIM that were just added to the BLAST code from the GLHEPRO software. The files are glhedata.dat, convert.inc, unitconv.ftn, and the g-function files.

The file glhedata.dat contains all the ground loop input information. Note the loads in that file are no longer read. The loads from BLAST are read by GLHESIM through another file (LOADS.DAT). The file convert.inc has just two common statements that are used by GLHESIM subroutines. GLHESIM uses its own functions for unit conversions, these are stored in the unitconv.ftn file. Finally the g-function files contains the data for all the possible ground loop configurations that are currently available in the GLHEPRO software. Only one such file is used for each borehole configuration.

It was decided since both software had their own interface that the input and output files from each program stay separate. The BLAST office may decide later on to change this as they see necessary. In the coming examples, especially the daycare center study case, the reader will learn how to write both input files and go through the whole design process.

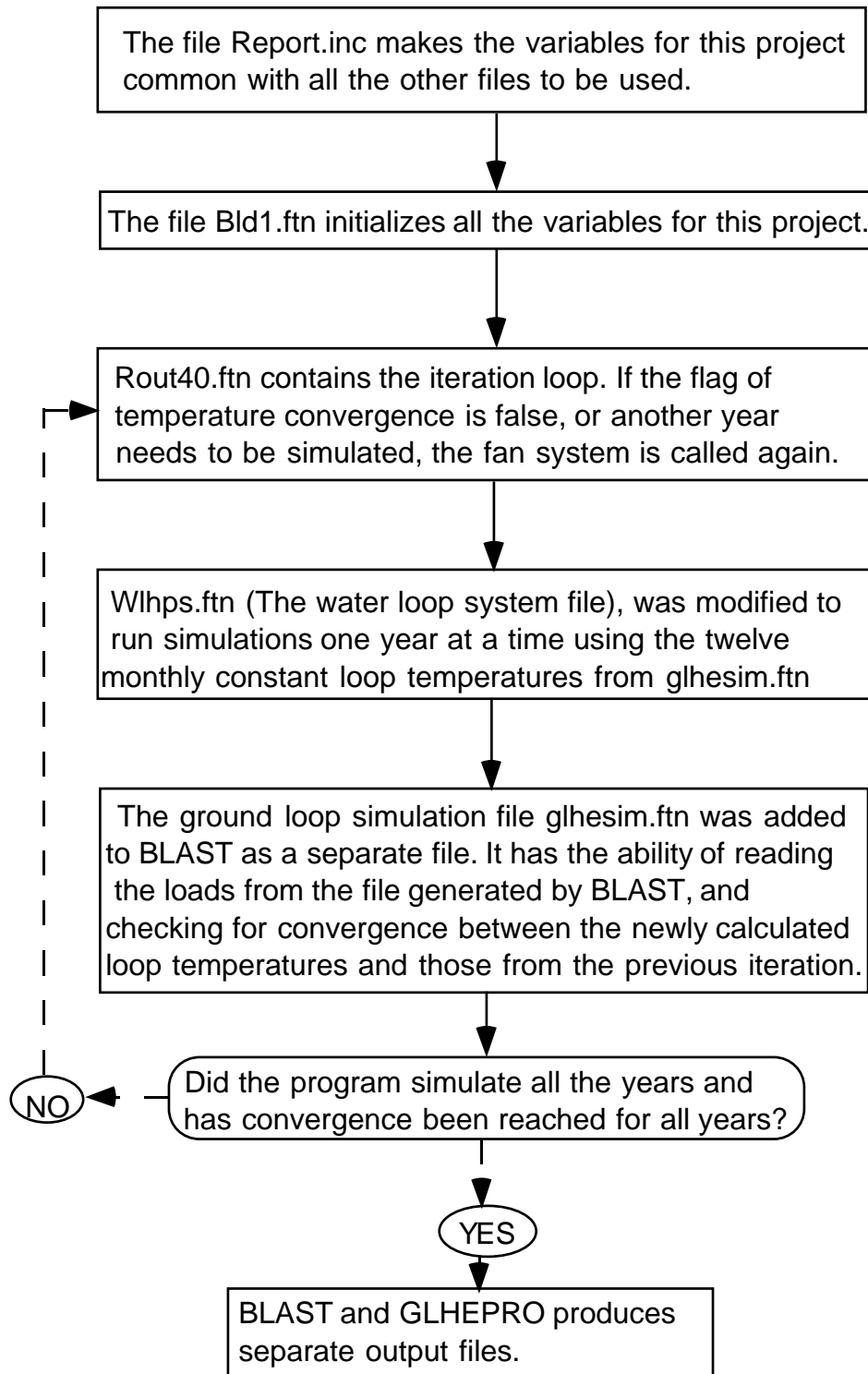

Figure 2.2, A Chart Outlining the Interaction Between the Modified Files

2.3 Testing the Modified Code

All through the development of this code, a simple two zone building was used to check that the modified code was doing what it was intended to do. Before making all the code changes, the methodology was tested by performing manual iterations. In other words after the WLHPS.ftn file was modified to run using the twelve monthly fixed ground loop temperatures, manual iterations were done. These iterations were intended to first test the methodology and second verify that the final modified code does indeed correspond to our methodology and has no bugs. In the next section, the BLAST input file WLHPTEST.blin of this two zone building is discussed briefly, following that is the results that were obtained from both the manual and automatic iterations using the modified code.

2.3.1 BLAST input file WLHPTEST.blin

For the purpose of simulation and testing the linking model, a very simple two zone building was prepared. It has the following dimensions. Zone 1 has a floor area of 3264 sq. ft., and zone 2 has a floor area of 5200 sq. ft. The building uses the Atlanta weather file. Each zone has one 45 KBTU/hr heat pump. In reality there may be more, but they can be superimposed to get one heat pump for each zone, (See BLAST 1993) The temperature control profile is the BLAST dead band profile which is supposed to keep the zone temperature between 68 and 78 °F. Note the system was not carefully designed as the later example of the real daycare center. The main point of this building was to create some reasonable building loads, that can be used for the purpose of testing the methodology.

2.3.2 Discussion of the WLHPTEST results

Note for the manual iteration, the only modification done was in the water loop subroutine. It had the flexibility of assuming twelve different loop temperatures instead of the one yearly temperature. Manual iteration means that the loads and loop temperatures were copied between the two programs and simulations ran in one program then the other and so on.

In GLHEPRO, a special input file was prepared for the building. The GLHEPRO file contains information about the ground loop, the soil and fluid used. Different number of boreholes in different arrangements were tried to select the most suitable one. Finally 6 boreholes in a square arrangement each of 150 ft depth, and 2.5 inches diameter were chosen.

In Appendix C, the reader may find a short summary of the iteration process, with only the monthly temperatures, and the loads of each iteration. Notice the iterations were started with some assumed temperatures of the loop, then the modified WLHPS.ftn along with all the original files of BLAST were used to calculate the loads. The output file was then taken to the GLHEPRO directory, so that GLHEPRO can read the loads.

Using GLHESIM a set of temperatures, that ranged from a minimum of 53.25 °F to a maximum of 76.96 °F were produced. Then taking the outlet temperatures of the ground loop and copying them into the data file for BLAST, a second simulation was run. Again with the loads calculated another set of temperatures was produced. This new set of temperatures matched the previous ones within 0.4°F (See figure 2.3). Recall the convergence criteria used was 0.5 °F. So the temperatures have converged in the second iteration. After many tests it was found that no matter what the first temperatures guesses are, the temperatures will converge within three iterations for a building with semi balanced heating and cooling loads.

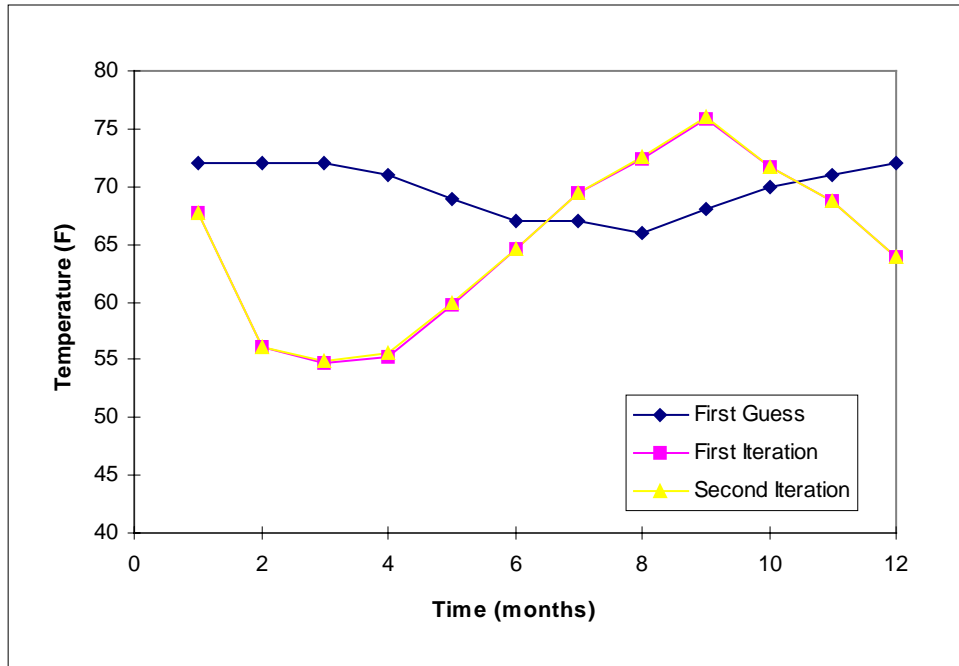

Figure 2.3 Manual iterations converging on the second iteration

Once the software was modified to do these iterations automatically for one year, a simulation using the same input files was run to check the code. After, debugging the new code, the agreement between the results from the manual iterations and those of the new ones was remarkably perfect. Even though the iterations for the new code started with a different temperature guess, convergence was reached on the second iteration, and the temperatures between these two methods matched within 0.01 °F.

The next step was to extend this model to more than one year. That involved repeating the same procedure and printing the GLHESIM results to the output file for each extra year. The changes in the code for this part of the project were mostly done in the ground loop simulation file `glhesim.ftn` (See appendix B). Right after convergence for year one is reached, the temperatures of the loop are printed to the output file, and another year's simulation is started.

The modified `glhesim.ftn` assumes as a first guess that the loads are not changed for year two, and calculates the loop temperatures for the second year using the loads of the first year for both years. These temperatures are then taken to BLAST and so on until the temperatures converge.

The same procedure continues until all years have been simulated. To study the procedure more carefully see the section on modifications in `glhesim.ftn` in appendix B.

In chapter 3, the final code is used with two different examples, for purposes of further studying and testing. All the steps of designing a ground loop heat pump system for any building are explored using a real building. Another example is used as a second check of this modified code as well as the original ones. In that example, the loads from the building are traced all through the system up to the ground loop. Then using the modified code and two other old simulation methods the loop temperatures exiting the ground loop are compared over a five year period.

3 Results and Discussion

In this section, two separate sample cases are covered. The first one labeled “validation of model” (See Appendix D.1) is simply a one zone building for which the loads on the heat pump are constant and not a function of the outside weather. This model is used to verify both the existing and modified codes. By holding the building loads constant, loads on the fan system and the ground loop may be easily estimated and compared to the ones produced by the existing models and the new code. A study and comparison between two other similar methods of simulating ground loop heat pump systems and the modified code is done using this one zone model.

The second example is the daycare center that was mentioned in chapter 2. In this example, the steps of designing the whole ground loop heat pump system are explored in detail. Simulations over ten year periods were carried out using the new code and one of the old simulation methods. The daycare center ground loop heat pump system is also compared to a dual duct variable air volume system based on operating cost and performance.

3.1 Validation of the Model

Validation of the model is done in two ways. First, some constant building loads are traced all through the system until they appear in some form in the ground loop system. Second, the results are compared with the old methods used in designing ground loop systems. Any differences are then discussed.

3.1.1 The Building Model in BLAST

The zone used was specifically designed to result in building loads that are independent of the weather outside. In other words all the walls, the ceiling, and the floor were specified as completely insulated. Also no outside air is admitted to the zone. The internal load was specified

to be 20 KBTU/hr. The zone has no other heat transfer possibilities and so the zone load is 20 KBTU/hr. The BLAST input file along with the output for the 8th year is in Appendix D.1.

From the sample run, notice that the building heating load is zero. The reason is obvious, there is nothing but internal loads in the insulated zone. The building remains at the maximum control temperature and only cooling is needed. The cooling load over the design days was 480 KBTU. That is the sum of the internal load (20 KBTU/hr) over twenty four hours. Note this is the load for both the winter and the summer design day. This shows that the loads are indeed independent of the outside weather.

The WLHPS loads report gives the loads on the heat pumps. For either of the design days in the BLAST output, the reader may also verify that the internal load is the only load on the heat pump. But then there is the load of the compressor of the heat pump that gets added on to equal the load on the plant, or the ground loop in our case. In the BLAST output file this load is basically the “Cooling Coil demand”. It was also verified that the monthly loads on the heat pump and the cooling coil are the sums of the hourly loads over the days of each month. To validate the existing heat pump model of BLAST, a comparison with the heat pump model in GLHEPRO was performed.

3.1.2 Validation of the Heat Pump Models

The heat pump used in the Validation zone building was modeled using both programs and results from each of these models are presented here. In BLAST there are some default performance values that may be used for a good first estimate. The results using the default values are good for all practical purposes as long as the water loop temperatures stay within 50 to 100 °F (Lash 1993). However more accurate results could be produced if the heat pump performance coefficients were used in the input file. The calculation of these coefficients may require a spread sheet software like EXCEL to do the data fitting of the heat pump performance. Section 3.1.2.1 has a sample calculation. On the other hand, GLHEPRO has a heat pump performance data fit feature built into the program. (Marshall and Spitler 1994). Calculating the

coefficients in GLHEPRO is fairly simple. Note the two models are structured differently and cannot be made to give identical results.

3.1.2.1 Calculation of Heat Pump Performance Parameters

Recall from section 1.2.5.2 that the heat pump performance in BLAST can be characterized by the following equations :

Cooling mode :

$$\frac{Capacity}{BaseCap} = A_1 + B_1 \left[\frac{T_{loop}}{T_{ref}} \right] + C_1 \left[\frac{T_{ref}}{\dot{m}_{base}} \right] \left[\frac{\dot{m}}{T_{wb}} \right] \quad (3.1)$$

$$\frac{EER}{BaseEER} = D_1 + E_1 \left[\frac{T_{loop}}{T_{ref}} \right] + F_1 \left[\frac{T_{ref}}{\dot{m}_{base}} \right] \left[\frac{\dot{m}}{T_{wb}} \right] \quad (3.2)$$

Heating mode :

$$\frac{Capacity}{BaseCap} = A_2 + B_2 \left[\frac{T_{loop}}{T_{ref}} \right] + C_2 \left[\frac{T_{ref}}{\dot{m}_{base}} \right] \left[\frac{\dot{m}}{T_{db}} \right] \quad (3.3)$$

$$\frac{COP}{BaseCOP} = D_2 + E_2 \left[\frac{T_{loop}}{T_{ref}} \right] + F_2 \left[\frac{T_{ref}}{\dot{m}_{base}} \right] \left[\frac{\dot{m}}{T_{db}} \right] \quad (3.4)$$

where

$$T_{ref} = 283 \text{ K or } 511 \text{ }^\circ\text{R}$$

$$T_{loop} = \text{The loop temperature (}^\circ\text{R or K)}$$

$$\dot{m}_{base} = \text{The rated mass flow per unit capacity multiplied by the base capacity.}$$

\dot{m} = The mass flow rate of water through the heat pump.

T_{db}, T_{wb} = The dry bulb and wet bulb air temperatures. ($^{\circ}\text{R}$ or K)

The coefficients of the mass flow rate terms are set to zero because the GLHEPRO Heat pump model is independent of the mass flow rate. The rest of the coefficients may be found from four simple linear fits of the heat pump manufacturer data given in the catalog. The heat pump used is SX036 from the Florida Heat Pumps catalog. The equations require base values for the cooling and heating capacities, EER and COP. Note using intermediate values for base values produces inaccurate results. Instead one should use the Base performance data in the Catalog. Appendix D.2 has this sample data fit carried out using EXCEL.

Notice in the example, that intermediate values for the wet bulb temperature, the dry bulb temperature, and the flow rate are used. In an actual building, the user might have already identified the average flow rate through the heat pump and may use that value. Using the least square fit each of the performance parameters was calculated.

In GLHEPRO, the coefficients may be found using the heat pump curve fit feature. A linear or quadratic data fit could be performed. Both fits are a function of loop temperature alone. Using these features, coefficients for both the linear and the quadratic fit were performed. See section 3.3.2.3 for detailed explanation of the GLHEPRO heat pump model.

3.1.2.2 Comparing the Heat Pump Models of BLAST and GLHEPRO

To illustrate the difference of using the different curve fit options of GLHEPRO, two plots of the ratio of heat rejected to total cooling versus ground loop exiting water temperature were created. Figure 3.1 illustrates two things. The BLAST model deviates away from the heat pump performance above 100°F. However for the range between 30 and a 100°F the BLAST curve fit of the Heat pump is really good. On the other hand it is obvious that although the linear fit of

GLHEPRO is real close to the heat pump performance, the quadratic fit would definitely produce better results.

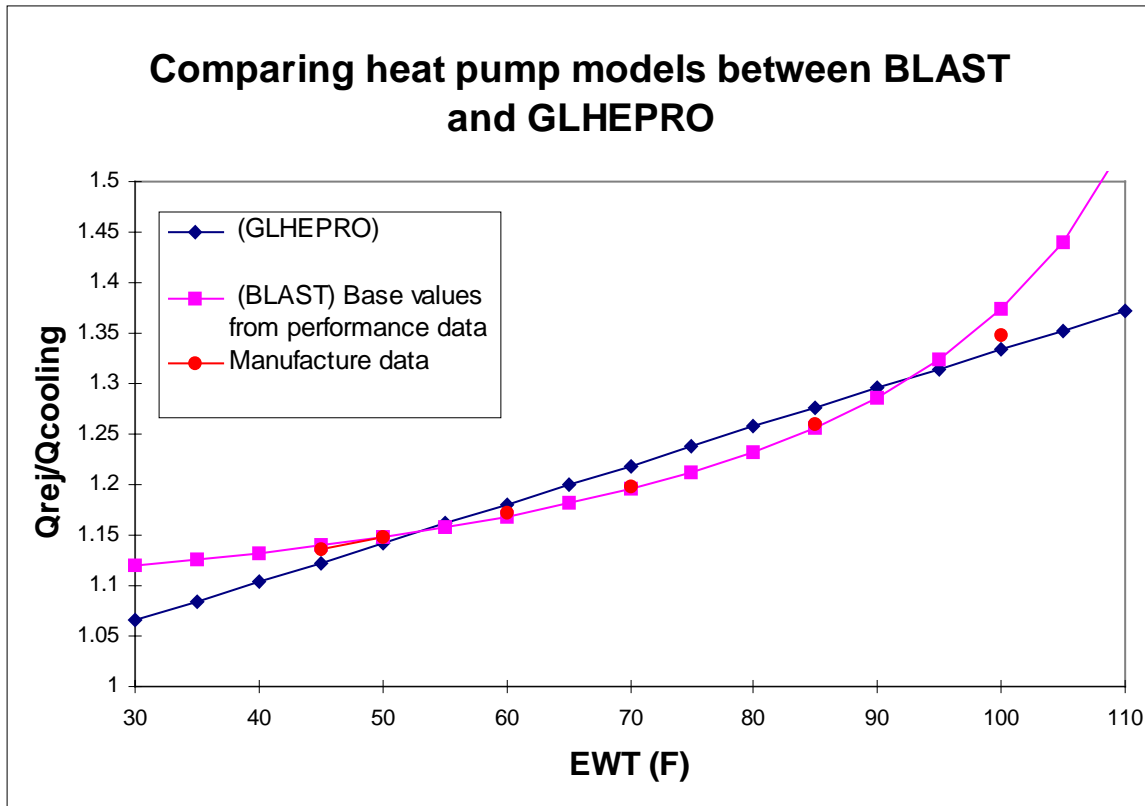

Figure 3.1 Comparing Heat Pump Models with GLHEPRO Using a Linear Fit.

Figure 3.2 has the same results as in figure 3.1 except for the GLHEPRO curve. That curve was generated using the quadratic fit. Notice the quadratic fit of GLHEPRO has even better range than the BLAST curve. With this, the heat pump models in both programs have been matched. The next step is to run the simulations with these two different heat pump models and compare the heat rejected to the ground.

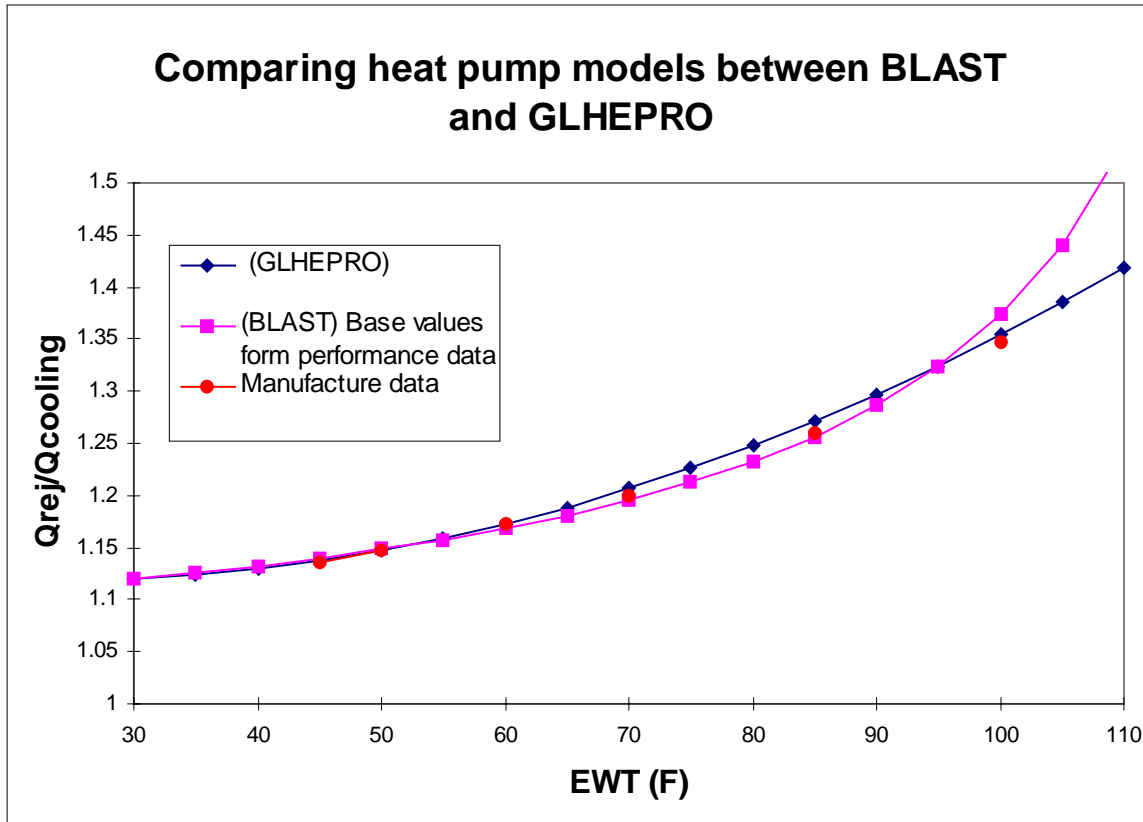

Figure 3.2 Comparing Heat Pump Models with GLHEPRO Using the Quadratic Fit.

3.1.3 Validation of the Water Loop Models

There are distinct differences between the BLAST and the GLHEPRO Water Loop models. The BLAST model (Lash 1993) is more sophisticated than the GLHEPRO one. It accounts for the heat pumps cycling on and off. It also accounts for the thermal mass of the loop, thus resulting in a slight lag in time between the plant outlet temperature and the water temperature entering the heat pump network. It is recommended that the user of the new code uses the least amount of loop mass possible. For this example 500 lb. of water are used. This accounts for a lag in time of few hours. Since the plant temperatures are constant for each month, this relatively short lag in time does not affect the overall results.

The difference between the two water loops and heat pump models can be better captured by studying the heat rejection to the ground by each loop. Recall that for the GLHEPRO simulation the loads on the heat pump from BLAST are transferred to the GLHEPRO software for

simulation, while in the BLAST simulation the loads on the plant are transferred to GLHEPRO. So in the latter case, the BLAST heat pump model is used. This is also true for the new code. It uses the water loop and heat pump models of BLAST along with the ground loop model from GLHEPRO.

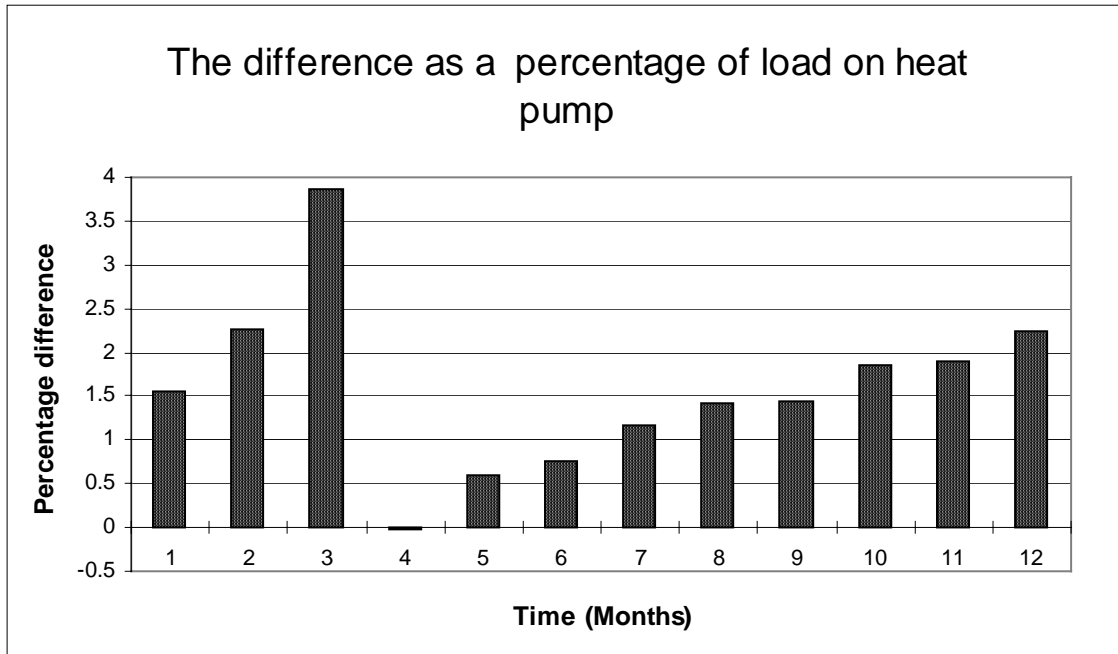

Figure 3.3 Difference Between the BLAST and GLHEPRO Models.

The results of these two simulations are summarized in figure 3.3. The difference of the heat rejection from both models is converted to a percentage of the load on the heat pump and plotted in figure 3.3. Appendix D.3 contains the spread sheets of these calculations. The average percentage difference over the twelve months is less than 1.6%. This kind of difference is acceptable for all practical purposes. In fact the percentage difference gets lower and lower as the ground loop temperature approaches a steady one as the next section will demonstrate.

3.2 Three Methods For Simulating Ground Loop Heat Pump Systems

In this section, the modified code results are compared with two other methods that were used prior to the development of this thesis. The first method is simply modeling the heat pumps in BLAST, then reading the cooling coil loads from BLAST and running GLHEPRO (No loop temperatures are fed back to BLAST). Note the coil loads represent the plant loads. The cooling coil loads are used because there is no heating for this problem. The other method is to model the heat pumps in GLHEPRO and then run GLHEPRO with the building loads from BLAST. This section discusses and compares these three methods.

3.2.1 Comparing the New Model of BLAST with the Model of GLHEPRO.

The difference between the two simulation methods here is the water loop and heat pump model. In the new code, the heat pumps and the water loop of BLAST are used. In the GLHEPRO model the heat pumps and the simple water loop of GLHEPRO are used. See section 3.1.2 and 3.1.3 for detailed explanation of the differences between the two models.

Using each of these methods the one zone building was simulated over a period of eight years. Figure 3.4a and 3.4b shows the ground loop exiting water temperatures versus time. Figure 3.4b is simply an enlargement of part of figure 3.4a. There are two curves for the BLAST model. One that converged within 1 °F, and another within 0.5 °F using the relaxation scheme. The third curve is the GLHEPRO one. There are a few things to be learned from this simulation. The GLHEPRO curve is smoother than the other two curves. However notice that the BLAST curve with the 0.5 °F convergence is slightly smoother and closer to the GLHEPRO results.

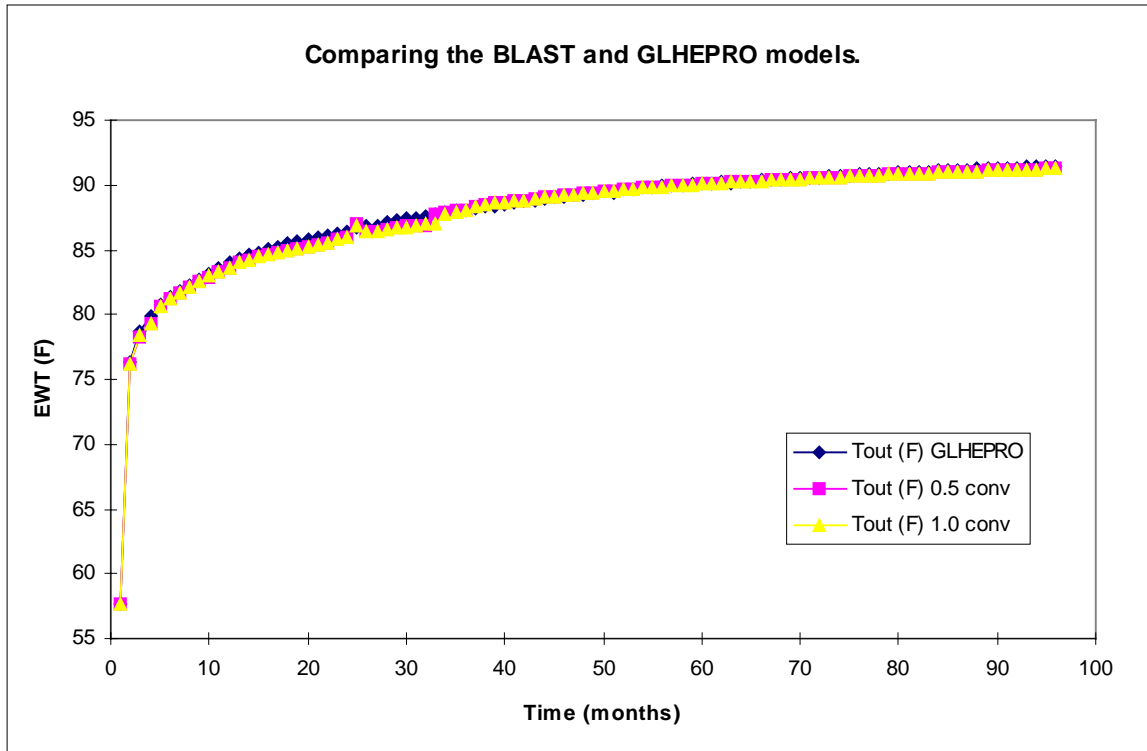

Figure 3.4a Comparing the BLAST and GLHEPRO Models

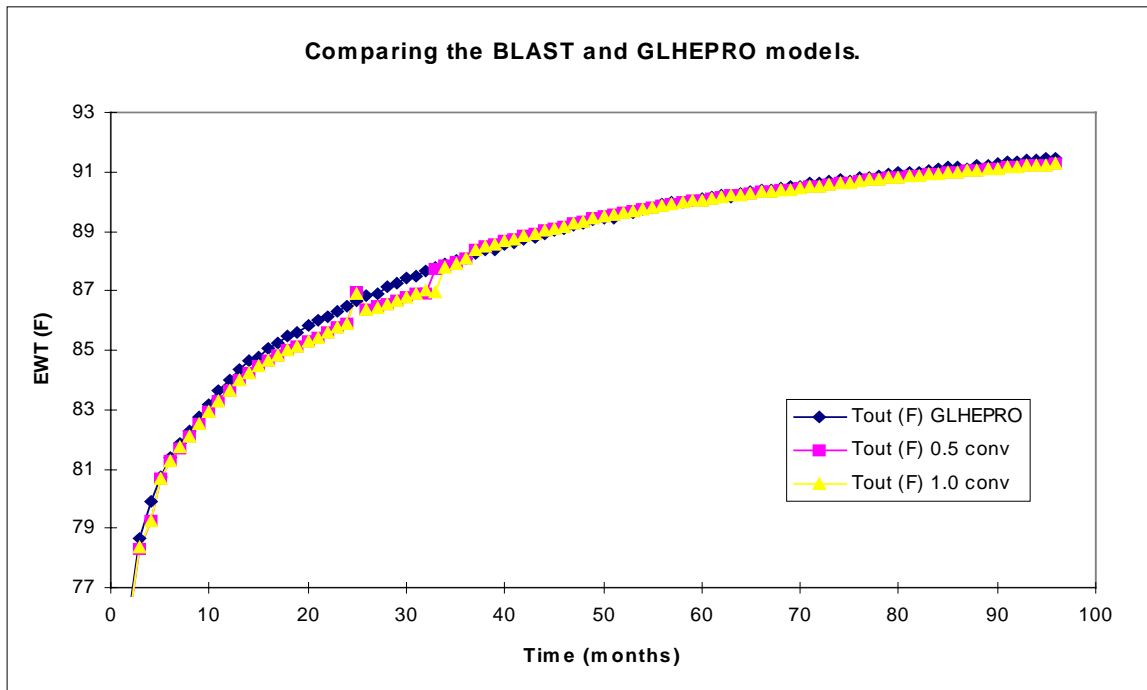

Figure 3.4b Comparing the BLAST and GLHEPRO Models

In addition to the differences between the water loop and heat pump models in BLAST and GLHEPRO, there is one more important difference between the two models. The dynamics of the iteration loops are different. In GLHEPRO the months over the whole period, in this case 96 months is simulated, followed by a convergence check for the whole period. If convergence has not been reached for one month, the 96 months are simulated over again. For example if the temperature for month 38 was too high, then all 38 months are simulated again to adjust the whole curve such that month 38 is a bit lower.

On the other hand, the BLAST iteration loop has to be in periods of twelve months. So once year one is simulated and convergence is reached, that year's results are printed to the file and may not be simulated again. For example if month 38 was too high, the twelve months temperatures of year four are adjusted so that convergence is reached, but the first three years cannot be adjusted. For that reason, the BLAST curves are not as smooth as the GLHEPRO one.

However the curves gets better as the convergence criteria is lowered. Figure 3.4 clearly shows that the convergence criteria of 0.5 °F produces good results for all practical purposes. As a matter of fact, even the 1.0 °F convergence criteria is acceptable. Notice both convergence criterias give exceptionally close results to the GLHEPRO model, as the water loop temperature approaches a steady state.

3.2.2 Comparing the GLHEPRO Model with the Simple Constant Loads Model

The simple constant loads model does not account for changes in the heat pump performance as the water loop temperature changes. (Because loop temperatures are not fed back to BLAST) The twelve monthly loads of the plant from BLAST are transferred to GLHEPRO to run the simulation without the GLHEPRO heat pumps*. In other words the loads on the ground loop are constant for each year of simulation. While in the GLHEPRO and BLAST models the changes in heat pump performance is taken into account.

* In order to do this a dummy heat pump is used. (See section 3.3.2.3 for details.)

The one zone model was simulated over an eight year period using the simple constant loads model and the GLHEPRO model. Results are shown as ground loop exiting water temperatures versus time in figure 3.5. To illustrate the difference of not accounting for the heat pump performance, the loads from year eight were chosen to be the constant loads for the simple simulation model. Year eight temperatures are higher than the past years. So the heat pumps of that year were running at a lower performance than the past years, thus the loads of year eight are a bit higher than the other years.

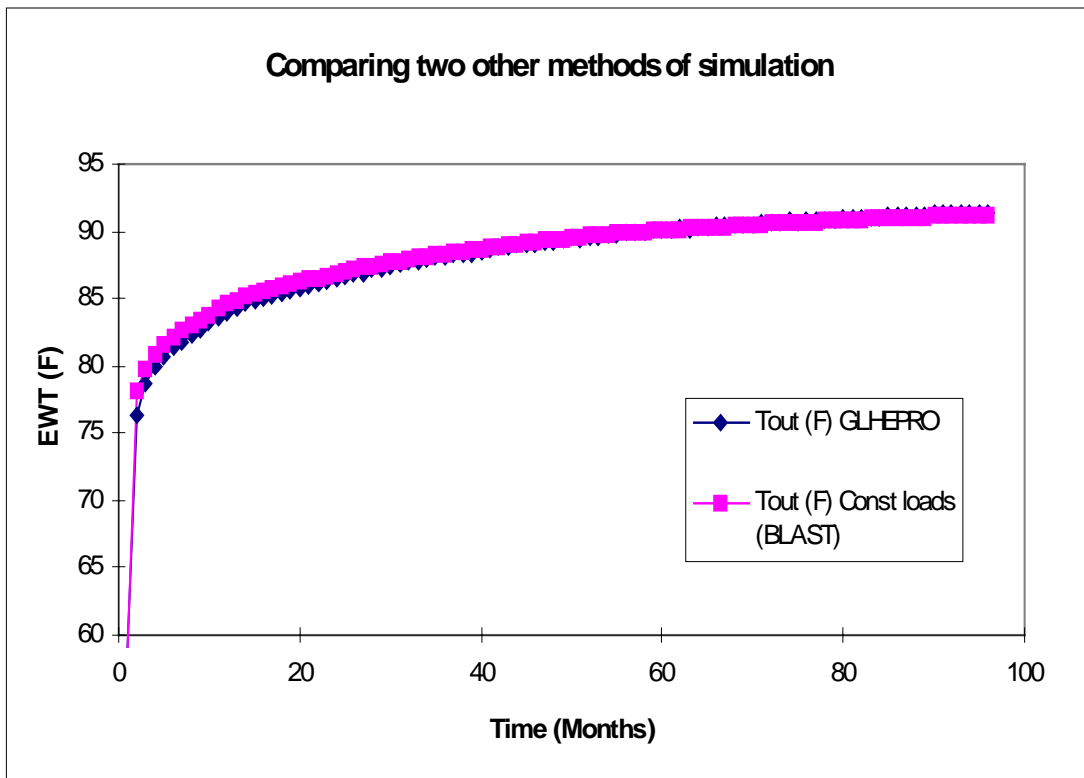

Figure 3.5 Comparing the GLHEPRO Model with the Constant Loads Model.

Looking at figure 3.5, it is easy to see that the temperatures using the simple constant loads model were higher than the temperatures from the GLEHPRO model in the first couple of years, but gets closer as time approaches the last year. This is as a result of using the relatively higher loads of year eight over the whole period of simulation. Never the less, for a first good approximation this method is also reliable. The one zone building used here, is a worst scenario case. The error of one month adds on to the next one and so on. In the case where the loads are a

function of outside weather, the errors from the summer months are reduced by the errors from the winter months for each year.

Using the simple constant loads method of simulation, the user would usually run the first year in BLAST using the BLAST heat pumps model, then transfer the plant loads to GLHEPRO for the ground loop simulation over as many years as desired. GLHEPRO has the ability of reading the plant loads directly from the BLAST output file.

3.2.3 A Summary of All Three Methods of Simulation.

This section is a summary of section 3.2. There are three ways to simulate a ground loop heat pump system. The new code developed uses the heat pump and water loop model of BLAST and integrates the ground loop model of GLHEPRO to form the complete model. The second method is using the GLHEPRO model, which only uses the building model of BLAST and uses the heat pump and ground loop models of GLHEPRO. The simple constant loads method, uses the BLAST models for one year, and assumes that the ground loop loads stay constant over the whole period of simulation. The plant loads are then used to simulate the ground loop in GLHEPRO. Usually that one year loads is the first year loads.

Figure 3.6 shows the results for the one zone building using all three methods. The results from the new code of BLAST and the results of the GLHEPRO model have better agreement than when compared with the results from the simple constant loads model. This is as a result of not accounting for changes in heat pump performance in the simple constant loads model.

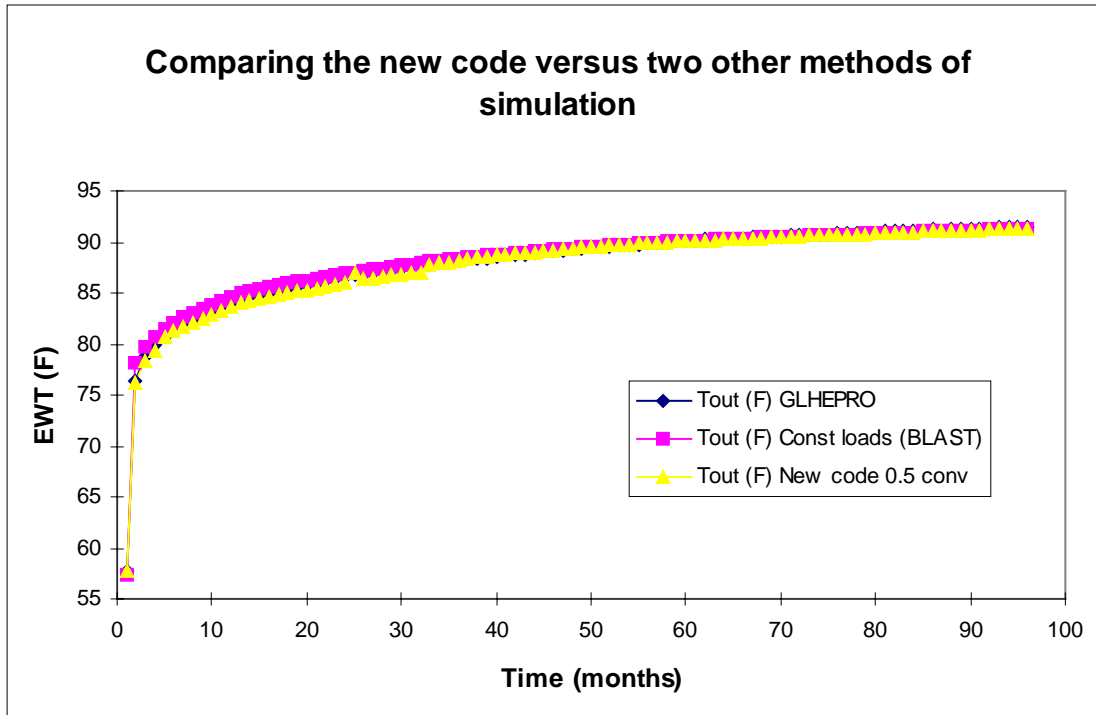

Figure 3.6 Comparing all three methods of simulation.

Thus the new code in BLAST and GLHEPRO are more accurate. The results of these two models for this example agree within 0.6 °F. In fact with the exception of a couple of months in years 2 and 3, the agreement is within 0.4 °F and gets better as the steady state temperature is approached near the last two years. As for the simple constant loads method when compared with the GLHEPRO results or the new code in BLAST, the maximum difference reaches about 1.5 °F.

However this difference is only true for one month in year one. From there on the difference gets smaller and smaller to match the BLAST model within 0.01 °F the last year of simulation. If the loads of the first year were used as the constant loads instead of the last year, the difference would have been greater at the end. In a real building the temperatures go through a yearly sinusoidal curve, which reduces the error depending on the distribution of the heating and cooling loads. If the users of these programs choose to use the simple constant loads method, it is simpler to just use the first year loads for simulation.

So far the discussion revolved around the models and the results of the different ways a ground loop heat pump system is simulated with little discussion of the mechanics of running the simulations. In the next section a sample problem is worked out in details to illustrate the designing procedure and the mechanics of using the new code.

3.3 A Sample Problem

In this section the design of a ground loop system for a daycare center using the new code in BLAST is explored in detail.

3.3.1 The Design Process

The user of this new code should follow this design process for designing and simulating the ground loop heat pump system chosen. The following is a summary of the design steps.

1. First a BLAST input file is created. The file should contain all the information about the building including location, design weather data, dimensions, building materials, internal loads for each zone, etc. (See the BLAST manual for more information).
2. Using this file, with the user specified temperature Control Profile, BLAST can calculate peak cooling, and peak heating loads for each zone.
3. These loads along with information about the weather and ventilation system are used to estimate the required heat pump capacities. Psychrometric charts are used in this process to analyze both the sensible and latent loads.
4. Appropriate heat pumps are then selected.
5. These capacities along with the performance data from the company's catalog are used to write the fan system part of the BLAST input file.
6. The final step in the design of the fan system is to use the results from the BLAST simulations to fine tune some of the loop parameters, keeping these parameters within the required design limits.

7. The next stage starts with selecting the “plant” that is to serve the fan system, in this case a ground loop heat exchanger.
8. A separate input file for the ground loop simulation has to be prepared. An experienced user of GLHEPRO can simply edit the input file. Otherwise the user may use the GLHEPRO software to create one.
9. The final step of this stage is to fine tune the size of the ground loop. The BLAST simulation is run for several years. The ground loop temperatures in the GLHEPRO output and the unmet loads in the BLAST output should be monitored. The ground loop is resized or another ground loop configuration is selected until the loads are accommodated and the loop temperatures are within the design limit.
10. The design procedure is completed by running a ten, twenty or twenty five year simulation, to study the long term effect of the loads on the ground capacity. The loop temperatures are checked. The temperatures need to remain within the design otherwise the unmet loads may increase beyond the design limits.

Using the daycare center these steps will be studied in detail in the next section.

3.3.1.1 Building Description in BLAST.

The first task is creating the BLAST input file that has a description of the building, location, materials used, internal loads, control profile etc. Figure 3.7 shows the daycare center top view. A smaller size copy of one of the original blue prints for the daycare center may be found in Appendix E.1. The daycare center is actually located in Vance Air Force Base in Enid, Oklahoma, but weather data from Oklahoma City will be used.

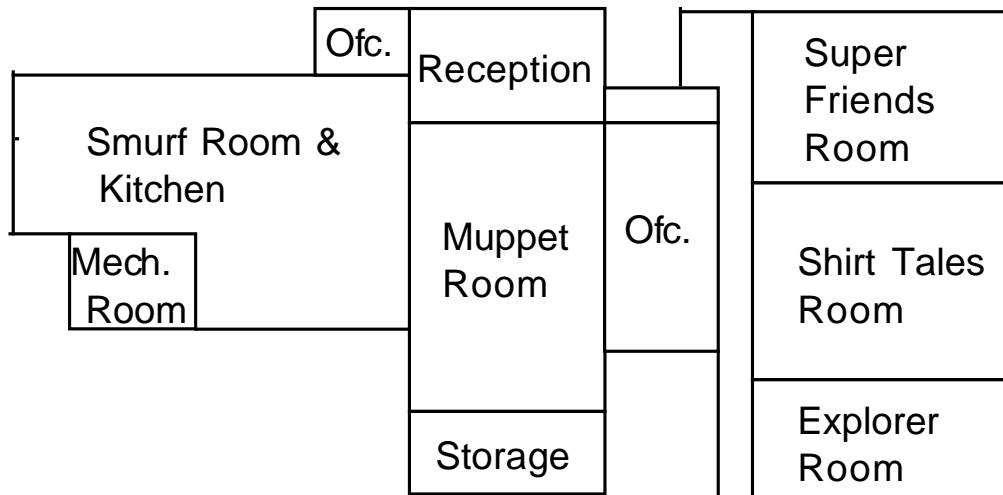

Figure 3.7 Daycare Center

The first step in the design process was to divide the building into several thermal zones. It was divided into six thermal zones, of which only four of these zones are ventilated and conditioned.

The zones are as follow :

ZONE 1 : The mechanical room was modeled as one zone due to the special equipment load in that room. Also that space is not normally occupied by people and so it does not need to be air conditioned.

ZONE 2 : Next to the mechanical room is the “Smurf” room. This room along with the kitchen the bathroom, the janitor room and the small storage room were modeled as one zone.

ZONE 3: This Zone includes all the spaces that would be directly affected by the high infiltration caused by the entrance. These spaces are the reception area, the small office and the short hallway between the “Muppet” room and the reception area.

ZONE 4: This zone is more or less an interior zone. It includes the “Muppet” room, the big office and the storage room south of the “Muppet” room.

ZONE 5 : This zone includes the three exterior rooms next to each other on the right side of the building. These rooms are the “Super Friends” room, the “Shirt Tales” room, and the “Explorer” room, in addition to the rooms the zone also include the hall way connecting them and the bathroom at the end of the hall.

ZONE 6 : Since this building has a false ceiling and a roof, the space in between which covers the whole building was modeled as one zone.

The dimensions, construction materials, etc. of each of these zones were input to the BLAST input file in the building description section using the BTEXT feature of BLAST (See BLAST manual.) Next the internal loads of each of these zone was specified. The loads are presented in table 3.1 below. The lighting and equipment loads were based on information deduced from the blue prints. The ventilation was calculated based on 15 cfm per person. Infiltration was calculated with the assumption that there is enough infiltration to replace the zone air volume each hour.

TABLE 3.1 DAYCARE CENTER INTERNAL LOADS.

Zone number	Number of people	Outside air vent (cfm)	Infiltration (cfm)	Lighting (KBTU/hr)	Equipment (KBTU/hr)
1	0	0	30	0	13.1
2	25	375	140	1.7	8.5
3	10	150	75	.85	5.1
4	25	375	120	1.87	8.5
5	30	450	250	2.04	5.1
6	0	0	400	0	0

All these loads including the outside air ventilation follow a schedule. The loads are 100 percent on between the hours eight to five every working day over the whole year, and off at all other times. The temperature control profile follows a similar schedule. See figure 3.8 below for the temperature profile. This is the control profile used when the building is occupied.

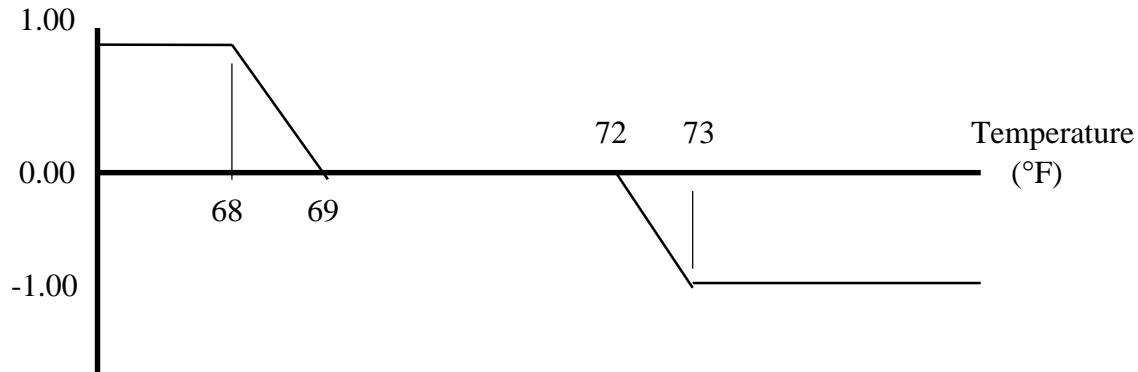

Figure 3.8 Occupied Control Profile.

When the building is not occupied the following profile shown in figure 3.9 is used. Note that the setback profile is much more relaxed, as it should be to save energy.

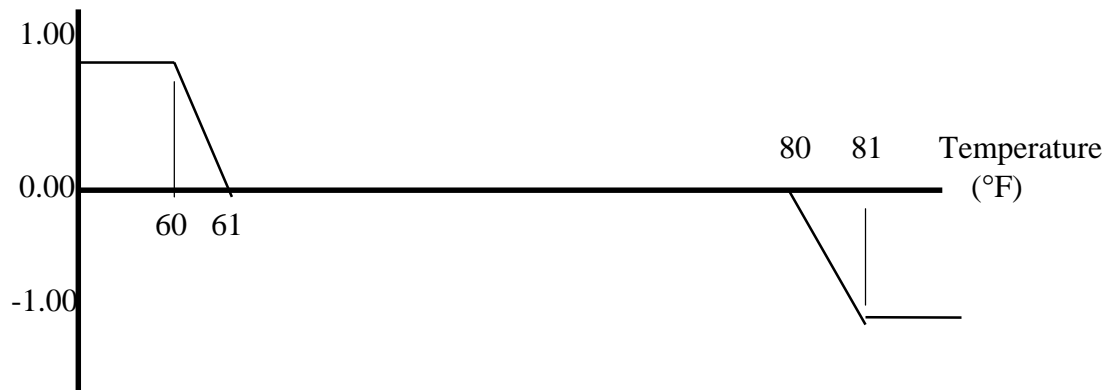

Figure 3.9 Unoccupied Control Profile.

This completes the building description. With this information the peak building loads may be calculated. The BLAST input file generated may be found in Appendix E.2.

3.3.1.2 Water Loop Heat Pump System Description in BLAST

Using the BLAST input file the building loads were generated. Table 3.2 below has these peak loads (See Appendix E.3 for a complete list of the loads). For the design process, usually the heat pump capacity is limited by the peak cooling load and not the heating one. There are two peak cooling loads that needs to be satisfied, the sensible load and the total load which is the sum of the sensible and latent loads. Both the sensible and the latent peak loads need to be satisfied. If it happens that the sensible load is satisfied but the latent capacity is slightly under designed, then the humidity for those peak hours would be slightly higher.

The next step is sizing the heat pump capacities based on these values using psychrometric charts. There are four psychrometric charts in appendix E.4, one for each conditioned zone. The whole ventilation process and energy states of the air for each zone may be found on the charts. For a sample calculation zone 2 was chosen. The calculation is actually an iterative process, in which a heat pump is selected and then the selection is checked. After a couple of iterations, the heat pump SX072 from the Florida Heat Pump Catalog was chosen for zone 2. The following is a sample of the iterations the designer should go through to select the appropriate heat pump.

TABLE 3.2 DAYCARE CENTER PEAK LOADS.

Zone number	Peak sensible cooling load (BTU/hr)	Peak total cooling load (BTU/hr)
2	20,810	26,580
3	18,130	20,441
4	18,260	23,243
5	24,060	29,839

Start with this information

Sensible cooling peak load = 20,810 BTU/hr
 Latent cooling peak load = 5,770 BTU/hr
 Temperature at which peak loads

occur (from BLAST output) = 69.99 °F at 97.28 °F ODB and 74.81 °F OWB
 Supply air flow rate (H.P Catalog) = 2,200 cfm
 Outside air ventilation = 375 cfm

Calculate the ratio of the sensible peak load to the total (SHF)

$$SHF = \frac{20,810}{(20,810 + 5,770)} = 0.783 \quad (3.5)$$

From the psychrometric chart select the specific volume of the air that is going to be delivered to the zone. In this case 13.1 $ft^3/lb.$ was chosen. This selection needs to be checked later on.

Next calculate the mass flow rate \dot{M} and the enthalpy of the air out of the heat pump.

$$\dot{M} = \frac{(2,200(ft^3 / min) * 60(min./hr))}{13.1(ft^3 / lb.)} = 10,076(lb./hr) \quad (3.6)$$

$$Dh = \frac{\dot{Q}_{total}}{\dot{M}} = \frac{(20,810 + 5,770)}{10,760} = 2.64(BTU / lb.) \quad (3.7)$$

Dh is the difference in enthalpy between the desired zone air enthalpy and the air supply delivered by the heat pump. So the required enthalpy at the heat pumps outlet is

$$H.P \text{ Enthalpy} = 25.3 - 2.64 = 22.66 \quad (3.8)$$

Using this value along with the SHF calculated earlier, locate on the psychrometric chart the required location of the heat pump outlet state. Next find the state of the mixed air, meaning the zone return air mixed with the outside air, which is delivered to the inlet of the heat pump. Recall there is a total of 2200 cfm of which 375 is outside air then approximately :

$$Enthalpy(MA) = \frac{375}{2,200} * Enthalpy(ODA) + \frac{1,825}{2,200} * Enthalpy(RA) \quad (3.9)$$

This is nothing but a weighted average of the outdoor air(ODA) and return air (RA) enthalpies.

$$Enthalpy(MA) = \frac{375}{2,200} * (38.4) + \frac{1,825}{2,200} * (25.3) = 27.5 BTU / lb.$$

With this, the energy cooling cycle(see the Psychrometric chart) is completed. It is time to calculate the sensible and latent cooling loads that the heat pump needs to meet.

$$\begin{aligned} Sensible Load &= \dot{M} * (Enthalpy@ A - Enthalpy@ H.P.outlet) & (3.10) \\ &= 10,760 * (25.8 - 22.7) = 31,236 BTU/hr \end{aligned}$$

$$\begin{aligned} Latent Load &= \dot{M} * (Enthalpy@ MA - Enthalpy@ A) & (3.11) \\ &= 10,760 * (27.5 - 25.8) = 17,129 BTU/hr \end{aligned}$$

so the $Total load = 31,236 + 17,129 = 48,365 BTU/hr$

Now check these loads against the information from the manufacturer's catalog.

The SX072 unit has two speeds (High and low). Entering the performance table at 75 °F entering air dry bulb and 62 °F entering air wet bulb, as deduced from the psychrometric chart, the reader may verify the following. At high speed operation, with entering water temperature of 100 °F and a flow rate of 10g/min., the heat pump can supply 9.2 percent more than the total load required and 16.85 percent more of the sensible load. Note for low speed operation these loads are satisfied for a maximum entering water temperature of 85 °F.

The same procedure was done for zones three, four, and five. A summary of the results is in table 3.3. These results were based on 100 °F entering water temperature at a flow rate within the heat pump capacity. Note that although the heating load over design is not shown here, it has been checked for each zone.

Zone 3 is a bit under designed. Recall that these numbers are based on 100 °F entering water temperature. In this ground loop it is our intention to keep the water temperature around 90 °F and not exceeding 95 °F. Interpolating for this water entering temperature it was verified that the loads will be met. Another consideration is the next larger unit would be too much over designed.

Using these units with their performance data the second section of the BLAST input file, the fan system section, was written. Again see appendix E.2 for this part. The reader is referred to the BLAST manual for the meaning of those parameters in the BLAST input file that are not clear. However there are a couple of things to be noted in the fan system section of the BLAST input file.

TABLE 3.3 A SUMMARY OF THE HEAT PUMPS CHOSEN.

Zone number	Calculated sensible load (BTU/hr)	Calculated total load (BTU/hr)	Heat pump unit number chosen	Sensible percentage over design	Total percentage over design
2	31,236	48,365	SX072	16.85	9.2
3	23,170	29,341	SX036	7.4	-0.8
4	28,200	45,700	SX072	21	15.54
5	48,872	71,780	SL100	10.7	5.7

The yearly fixed temperature option for the water loop temperature control was chosen. When running the modified code the yearly fixed temperature will be replaced by the monthly exiting water temperature from the ground loop. This is a temporary situation until the BLAST office adds the new control option to the BLAST input language. In other words the BLAST version that contains the GLHEPRO option will have one additional loop temperature control, the monthly constant one. So at this stage it does not matter what value is put in the fixed loop temperature entry.

It was found through experience that a good temperature for initial simulations using the unmodified BLAST code is 69 °F. This temperature was used to fine tune the loop parameters before linking the ground loop (using the modified code). Fine tuning means, trying the heat pumps chosen, checking the unmet loads, and adjusting the parameters as loop mass, mass ratio etc.. Once the unmet loads are reasonable (Less than five percent of total load), then we may move on to designing the ground loop system. Note all this time the BLAST software assumes a very big plant is serving the fan system.

The results of running the fan system simulation are in appendix E.5. The simulation was carried out with Oklahoma City weather file for the year 1979. You may browse through the simulation for any information needed. So far the old code of the water loop heat pump system has been used. For more information on the design and input parameters see the BLAST manual.

A special summary of the end of year results is in table 3.4. Recall the internal loads are presented in table 3.2. The fixed loop temperature used for this simulation was 69°F. The loop mass including the ground loop was 1350 lb. of water and no thermal storage tank was being used, since the ground loop will serve as one when linked.

TABLE 3.4 A SUMMARY OF THE SIMULATION RESULTS FOR THE FAN SYSTEM ALONE.

Category	Zone 2	Zone 3	Zone 4	Zone 5	Building	Fansys.
UH (hr)	15	15	18	17	-	65

UH (KBTU)	0.717	0.51	0.884	3.775	-	5.88
UC (hr)	0	0	0	0	-	0
UC (KBTU)	0.0	0.0	0.0	0.0	-	0.0
OH (hr)	0	0	0	0	-	0
OH (KBTU)	0.0	0.0	0.0	0.0	-	0.0
OC (hr)	0	4	1	2	-	7
OC (KBTU)	0.0	0.158	0.075	0.095	-	0.328
HWD (hr)	0	0	0	0	-	0
CWD (hr)	0	0	1	0	-	1
Heating (KBTU)	-	-	-	-	132,200	118,100
Cooling (KBTU)	-	-	-	-	59,270	153,900
Electric (KBTU)	-	-	-	-	-	104,400

UH and UC stands for under heating and under cooling respectively. Likewise OH, OC is over heating and over cooling. HWD, CWD are the heating and cooling without demand loads.

Finally a dash means the value for this entry is not applicable or is of little importance and so was omitted to keep the reader focused. However the reader may look in the output file in appendix E.5 for more information.

Note the unmet loads are negligible. The heating and cooling loads of the building are the sum of the zone loads. The loads listed under the fan system are the loads that need to be supplied by the plant. The electric load under the fan system is the amount of electricity required to run the heat

pumps and the water loop pump. The next step is to design the ground loop serving the fan system.

3.3.2.3 Ground Loop Heat Exchanger Description in GLHEPRO

Recall that a special input file is required for the ground loop. This could either be made through the GLHEPRO software (Marshall and Spitler 1994), or simply by editing the glhedata.dat file directly. Information about the soil, the fluid used, the flow rate, the heat pump performance curves and the boreholes needs to be specified. One important point not mentioned in the GLHEPRO manual is how to use the ground loop model without using the GLHEPRO heat pump models. In the new code and the simple constant loads method discussed in previous sections the heat pump is modeled in BLAST.

To “avoid” using the GLHEPRO heat pump model, the coefficients of the performance curves are set such that the loads passed to GLHEPRO are actually heat rejected to the ground and heat extracted from the ground. The following equations are the heat pump curve fits used in GLHEPRO. The parameters in the following equations need to be specified in the GLHEPRO input file as shown, in order to bypass the GLHEPRO heat pump model.

For Cooling:

$$\text{Heat of Rejection} = QC[a+b(\text{EFT})+c(\text{EFT}^2)] \quad (3.12)$$

$$\text{Power} = QC[d+e(\text{EFT})+f(\text{EFT}^2)] \quad (3.13)$$

$$a = 1.000000$$

$$b = 0.000000$$

$$c = 0.000000$$

$$d = 0.000000$$

$$e = 0.000000$$

$$f = 0.000000$$

Similarly For Heating:

$$\text{Heat of Absorption} = QH[a+b(\text{EFT})+c(\text{EFT}^2)] \quad (3.14)$$

$$\text{Power} = QH[d+e(\text{EFT})+f(\text{EFT}^2)] \quad (3.15)$$

$$a = 1.000000$$

$$b = 0.000000$$

$$c = 0.000000$$

$$d = 0.000000$$

$$e = 0.000000$$

$$f = 0.000000$$

If the user possesses both the BLAST and the GLHEPRO codes, it is suggested that the simple constant loads method or the GLHEPRO method of simulation be used to get a good first guess of the size and appropriate borehole configuration. Refer to the GLHEPRO manual on how to simulate the ground loop if using the GLHEPRO model. If using the simple constant loads method, then there are four things that needs to be done.

1. Manually transfer the cooling and heating coil loads, i.e. the plant loads from the BLAST output file to the GLHEPRO program.
2. In GLHEPRO, use the same heat pump coefficients as shown above so that these loads are converted to ground loop loads without any changes in their numerical values.
3. Use the GLHESIM or GLHESIZE options to simulate the ground loop for one year then for several years. GLHESIM will produce a good estimate of the final loop temperatures.
4. Fine tune the loop size and configuration such that the exiting water loop temperatures fall within the desired temperature range.

In this example, the desired temperature range is between 45 and 90 °F. Note this range is more restrictive than necessary. Usually the design temperature range is wider than that. An example

of the GLHEPRO input file is in appendix E.5. Note the loads of that input file are not the daycare center loads. This is the file used with the modified code for which the loads are transferred internally between the subroutines and are not read from the input file. So it does not matter what these loads are. However for the initial simulations using the GLHEPRO or the simple constant loads method, the user must use the appropriate loads as discussed previously.

After a few simulations it was found that nine boreholes in a square would give reasonable temperatures. The loop exiting temperatures were somewhere between 45 and 80 °F. The final step is running simulations using the new code of BLAST to calculate the unmet loads. Note the step of using GLHEPRO or the simple constant loads method to size the ground loop may be skipped and replaced by a trial and error use of the new code alone. Try some borehole size and configuration, if the ground loop exiting water temperatures are too high, choose a bigger loop and visa versa until the temperatures are within the design limits chosen.

Before moving on to the results for a one year simulation. It is important to illustrate the GLHEPRO model’s sensitivity to the soil and borehole parameters as discussed in chapter 1. Table 3.5 shows the effect of decreasing the soil conductivity, volumetric heat capacity, and borehole thermal resistance. This table was generated using the GLHEPRO software using a ten year simulation. Note that the parameter that causes the most change in the loop entering water temperature is the soil conductivity. So special care should be taken in determining a precise value for the soil conductivity. Finally, a change in the undisturbed ground temperature shifts the loop temperatures by approximately that change. It is not exactly the same change because the heat pump performance changes slightly with that shift in loop temperatures. So it is also important to accurately determine the undisturbed ground temperature.

TABLE 3.5 GLHEPRO MODEL’S SENSITIVITY TO SOIL AND BOREHOLE PARAMETERS

Varied Parameter	Change in Minimum EWT (°F)	Change in Maximum EWT (°F)
------------------	-------------------------------	-------------------------------

10 % decrease in conductivity	0.88 decrease	1.28 increase
20 % decrease in conductivity	1.92 decrease	2.84 increase
10 % decrease of volumetric heat capacity	.06 decrease	.07 increase
20 % decrease of volumetric heat capacity	.14 decrease	.27 increase
10 % decrease in borehole thermal resistance	.38 increase	.45 decrease
20 % decrease in borehole thermal resistance	.78 increase	.94 decrease

3.3.2 Results for a One Year Simulation

Using the modified code, the daycare center was simulated for one year to investigate the effect of the loop temperatures on the fan system. Figure 3.10 shows the exiting water temperatures of the ground loop. Recall that after the ground loop calculates the exiting ground loop temperatures, BLAST simulates the fan system using the new temperatures, which changes the unmet loads. This process persists until convergence is reached. So it is important to compare the results of this run with the results from the one year simulation of the fan system alone for which a constant 69°F loop temperature was assumed. Table 3.6 has a summary of the results from the BLAST output file of the one year simulation using the new modified code.

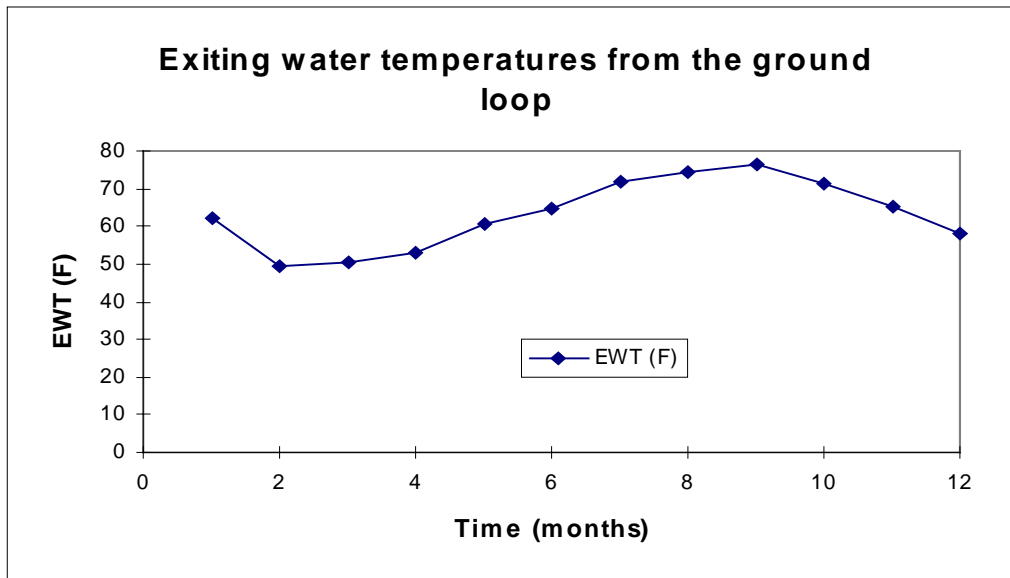

Figure 3.10 Daycare Center EWT of the Ground Loop For the First Year.

TABLE 3.6 A SUMMARY OF THE RESULTS FOR A ONE YEAR SIMULATION OF THE DAYCARE CENTER USING THE NEW CODE.

Category	Zone 2	Zone 3	Zone 4	Zone 5	Building	Fansys.
UH (hr)	27	24	33	29	-	113
UH (KBTU)	4.33	1.88	4.68	33.5	-	44.3
UC (hr)	0	0	0	0	-	0
UC (KBTU)	0.0	0.0	0.0	0.0	-	0.0
OH (hr)	0	0	0	0	-	0
OH (KBTU)	0.0	0.0	0.0	0.0	-	0.0
OC (hr)	2	6	4	3	-	15
OC (KBTU)	0.087	0.45	0.36	0.51	-	1.407

HWD (hr)	0	0	0	0	-	0
CWD (hr)	0	0	2	0	-	2
Heating (KBTU)	-	-	-	-	132,200	115500
Cooling (KBTU)	-	-	-	-	59,270	154100
Electric (KBTU)	-	-	-	-	-	106500

In comparison with the results, of the one year simulation of the fan system alone, (see table 3.4). It is clear that the under heating hours and loads have slightly increased in all the zones. The reason is obvious, the temperatures in the loop went as low as 49 °F instead of the constant 69 °F supplied . So it is reasonable to see the underheating loads go up a bit. These unmet loads are still within the design limits. Note again there is no under cooling. The maximum loop temperature of 76.7°F is far away from the design one of 95 °F.

Note that the exiting temperatures which range between 49.3 to 76.7 °F. are well within the design criteria. Both of these values would be expected to rise slightly with time due to heat build up in the ground. These long term effects are studied in the next section.

3.3.3 Studying Long Term Effects

Using the nine boreholes in a square with B/H = 0.2 (field size) as before, a ten year simulation was carried out to study the effect of heat build up if any on the fan system. The BLAST and GLHEPRO output files for this run may be found in appendix E.6. The best way to illustrate the slight heat build up is by graphing the exiting water loop temperatures. See figure 3.11 below.

It might not be obvious from the first glance, but the exiting loop temperatures have slightly increased. In fact the minimum temperature increased from 49.3 to 50.3 °F, and the maximum temperature increased from 76.7 to 77.8 °F over the ten years period. The heat build up is a direct result of having slightly more cooling load than heating in the daycare center. Table 3.7 below summarizes the results from the BLAST output file.

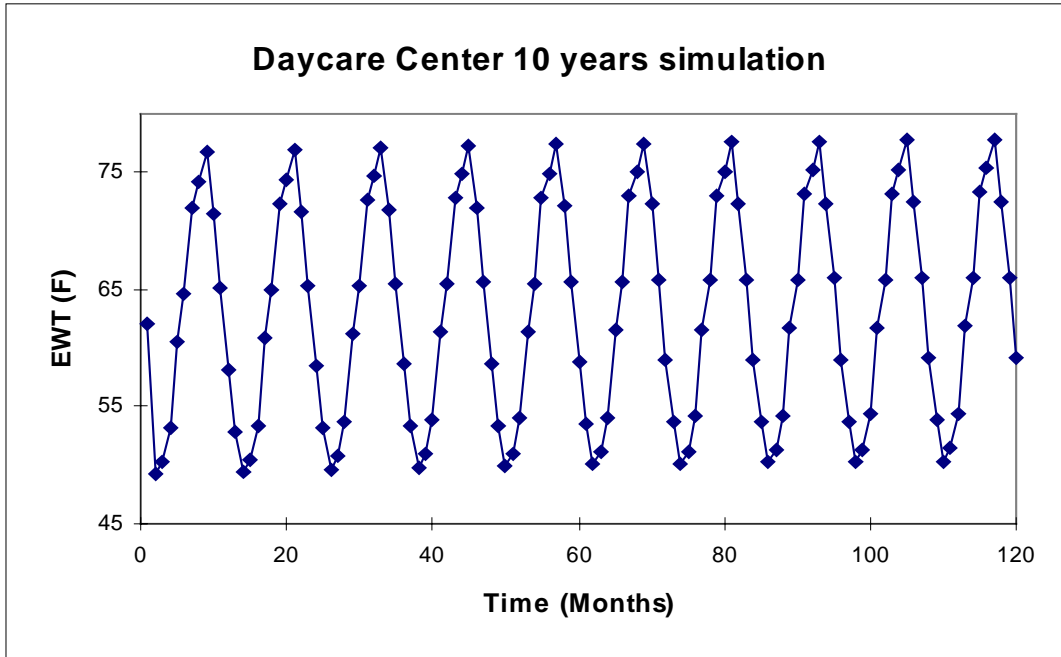

Figure 3.11 Heat Build Over a Ten Year Period for the Daycare Center

TABLE 3.7 A SUMMARY OF THE RESULTS FOR A TEN YEAR SIMULATION.

Category	Zone 2	Zone 3	Zone 4	Zone 5	Building	Fansys.
UH (hr)	27	23	32	35	-	117
UH (KBTU)	9.545	1.755	9.375	66.67	-	87.43
UC (hr)	0	0	0	0	-	0
UC	0.0	0.0	0.0	0.0	-	0.0

(KBTU)						
OH (hr)	0	0	0	0	-	0
OH (KBTU)	0.0	0.0	0.0	0.0	-	0.0
OC (hr)	1	5	4	3	-	13
OC (KBTU)	0.057	.455	.326	.4724	-	1.3104
HWD (hr)	0	0	0	0	-	0
CWD (hr)	0	0	0	2	-	2
Heating (KBTU)	-	-	-	-	132,200	115,200
Cooling (KBTU)	-	-	-	-	59,270	154,400
Electric (KBTU)	-	-	-	-	-	107,000

The results above show that the under heating loads did not decrease over the ten year period as compared to the one year simulation. This slight increase in the exiting loop temperatures of 1°F over the ten year period does not affect the unmet loads and the performance of the system all that much. Also the system still does not have any under cooling, as the maximum loop temperature of 77.8 °F is still far away from the design limit of 95 °F.

This completes the design and discussion of the ground loop heat pump system for the daycare center. In the next section the results of this simulation will be compared with results from the simple constant loads method.

3.3.4 Comparing the New BLAST Model Results with the Results from the Simple Constant Loads Model

Recall from section 3.2.3 that one of the old techniques was to simulate the heat pumps in BLAST, produce plant loads, then use the loads to run GLHEPRO. This technique was run on the daycare center to compare results with the BLAST modified code. In both methods the heat pumps and water loops are modeled in BLAST. The only difference is that the old method does not account for the changes in the heat pump performance due to changes in the loop temperatures. Still the exiting loop temperatures from both methods should be quite close.

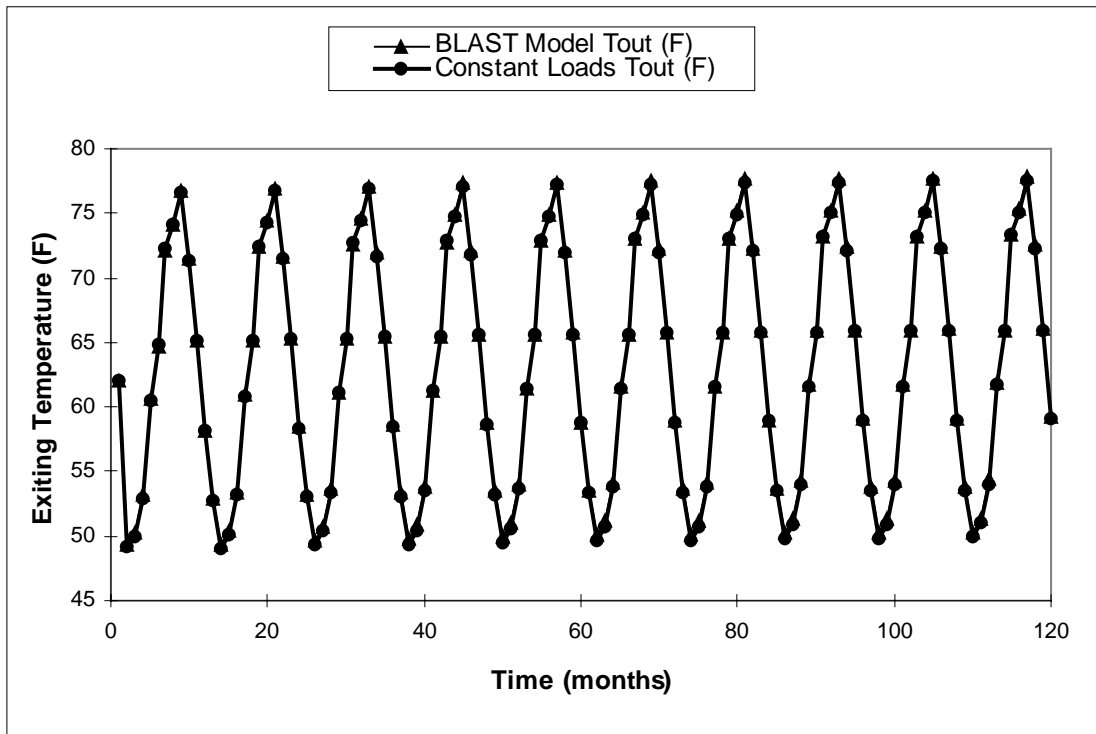

Figure 3.12 Comparing EWT for the Daycare Center Using Two Methods of Simulation

Figure 3.12 has a graph of the exiting loop temperatures from both methods. It is easy to see that the temperatures from the two methods agree real well. Actually from the numerical values the two methods agree within 0.4 °F. The conclusion that may be drawn from this simulation and those in section 3.2 is that the method of constant loads is fairly accurate when used with a building that has a semi balanced heating and cooling loads. However for a building that has unbalanced loads, the new code supplies more accurate information about the loop temperatures. But note that the unmet loads can only be calculated using the new code.

3.3.5 Comparing the Ground Loop System with a Dual Duct VAV System

Using BLAST a dual duct variable air volume system was designed for the daycare center to compare its energy consumption with that of the ground source heat pump system. The reader is referred to the BLAST Manual for more information about the system and the steps involved in designing it. In the BLAST input file, the section that has the building description, internal

loads, control profile, etc. stays the same. All that is changed is the fan system and the plant parts. Table 3.8 has some of the important parameters used in the fan system and the plant.

TABLE 3.8 PARAMETERS USED IN THE DESIGN OF THE DUAL DUCT
VAV SYSTEM

Mixed air Control	Fixed amount
Outside air	1350 CFM
Cold deck temp.	45 °F
Hot deck temp.	135 °F
Desired mixed air temp.	64 °F
Boiler size	210 KBTU/hr
Chiller size	210 KBTU/hr

Table 3.9 summarizes the results from the BLAST output file. The table has the yearly unmet loads and the yearly energy demands of the building and the fan system.

TABLE 3.9 A SUMMARY OF THE DUAL DUCT SYSTEM RESULTS.

Category	Zone 2	Zone 3	Zone 4	Zone 5	Building	Fansys.
UH (hr)	2	1	2	2	-	7
UH (KBTU)	5.74	0.17	6.46	7.67	-	20.05
UC (hr)	0	0	0	0	-	0
UC (KBTU)	0.0	0.0	0.0	0.0	-	0.0
OH (hr)	0	0	0	0	-	0
OH (KBTU)	0.0	0.0	0.0	0.0	-	0.0
OC (hr)	0	0	0	0	-	0
OC (KBTU)	0.0	0.0	0.0	0.0	-	0.0
HWD (hr)	0	0	0	0	-	0
CWD (hr)	0	0	0	0	-	0
Heating (KBTU)	-	-	-	-	133,600	254,200
Cooling (KBTU)	-	-	-	-	59,250	233,700
Electric (KBTU)	-	-	-	-	-	31,670

From these results there are two things to be noted. First the building loads are essentially the same for both systems. Second, although the unmet loads are not the same between the two systems, the difference is less than 0.1 percent of the total building heating load. The two systems are compared based on the total consumed energy. This includes the heating consumption, the

cooling consumption, and the electricity. Figure 3.13 shows the yearly purchased energy for each system.

It is easy to see that although the ground loop system consumes much more electricity, (Mostly used by the heat pumps.) its savings in terms of heating and cooling far exceeds that loss. The figure shows that the heating and cooling for the ground loop system is free since it is extracted from the ground. In the dual duct VAV system, the heating is provided from the boiler using natural gas as the energy source. The cooling is provided by the chiller using electricity. Assuming the boiler has an efficiency of 0.9, the chiller has a COP of 3.5, the electricity costs .0235 \$/ KBTU and natural gas cost 0.0032 \$/ KBTU, the yearly cost of operating each system was calculated*. Figure 3.14 shows in U.S dollars the cost of operating each system.

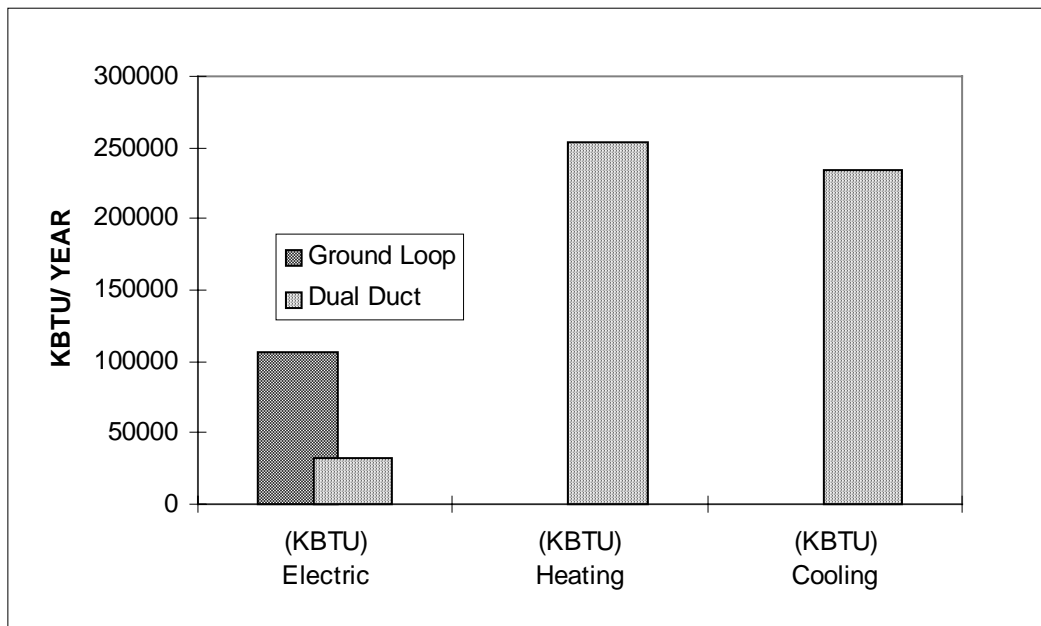

Figure 3.13 Yearly Energy Consumption

* The rates for the electricity and the natural gas reflects the rates in Stillwater for March, 1996. (.08\$/KWh for electricity, .0032\$/KBTU for gas.)

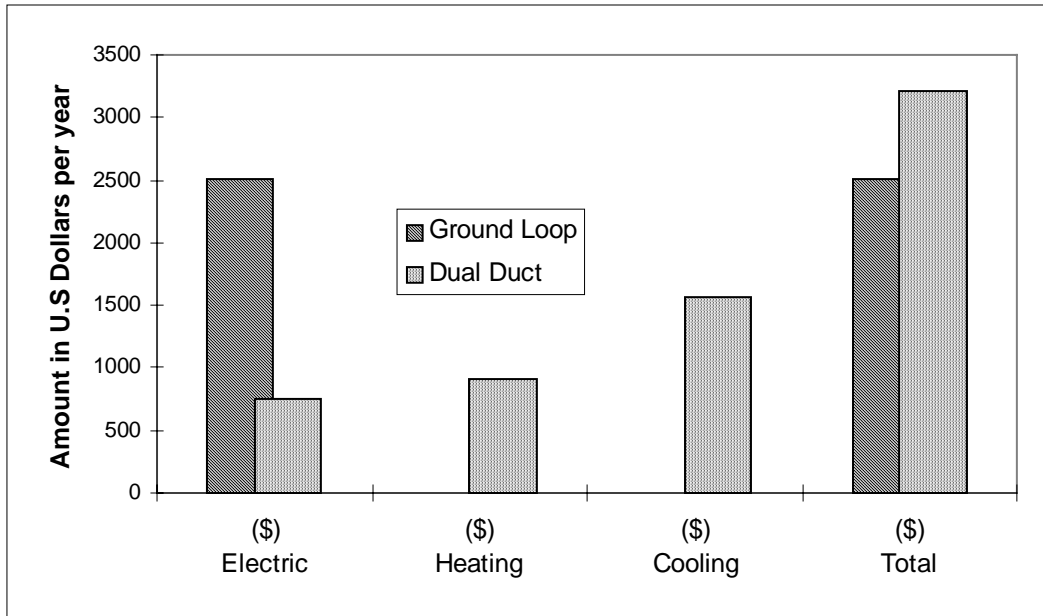

Figure 3.14 Yearly Operating Cost

It is evident from the above figure that using the dual duct VAV system for the daycare center costs more than the ground loop heat pump system. Although a ground loop heat pump system uses more electricity to run, the heating and cooling are free making the system one of the most economical systems.

4 Conclusions and Recommendations

4.1 Summary and Conclusions

The investigation started with a study of the two existing models. Then based on a careful analysis of the code from the two software, a methodology for integrating the GLHESIM model into the BLAST code was formed. The methodology was tested by manual iterations before the subroutines were integrated. These initial tests showed promising results such as quick convergence of the loop temperatures regardless of the initial guess.

The second phase of the project was to integrate the subroutines to the point where BLAST had the ability to run ground loop simulations for one year. As was shown in chapter 2, the results from this modified code agreed perfectly with the manual iterations. So the next step was simply to extend the same methodology to more than one year which allows the user to study the long term effects or the transient response.

The final code, has the ability to run simulations over a period of 25 years. The dynamics of the modified code are such that the results from the ground loop and the fan system communicate each year of simulation to ensure that the loop temperatures in both systems are the same. This kind of interaction as shown in chapter 3 is essential for accurate results in the BLAST unmet loads, water loop reports, and the ground loop output file.

Many conclusions may be drawn from the insulated one zone building results. At the beginning of that section the one zone building was used to discuss and validate the existing models in both BLAST and GLHEPRO by tracing the building loads all through the process in both models up to the point where the loads are rejected to the ground. The one zone model was also used to study and compare the new code with two other previous methods of simulation.

It was shown that the new code of BLAST produced results that were in good agreement with the ones from the GLHEPRO model. The simple method of constant loads was also discussed and compared against the new BLAST model and the GLHEPRO model. The difference between the

constant loads model and the other two is this model does not account for the changes in the heat pump performance, and thus is not as accurate as the other two methods.

Using the Daycare center as a sample problem, the recommended design process was demonstrated in details. One of the most important conclusions of this example is that only the new code provides accurate results about the effect of heat build up on the performance of the system. No other method of simulation provides information about the unmet loads for the last year of simulation. This is only possible through the yearly interaction between the water loop system of BLAST and the ground loop system of GLHEPRO which only takes place in this new BLAST code.

Finally using the Dual Duct Variable Volume system, it was shown that although a ground source water loop heat pump system uses more electricity than other conventional systems, the amount of cooling and heating purchased for conventional systems is much more than the difference in the electric bill.

4.2 Recommendations

This section of recommendation stems from observations during the development of this thesis. For future work, a study of the time step used in BLAST would be of great benefits in cutting down on simulation time. All through the project, optimization of the CPU time was one of the priorities. The water loop simulation subroutine uses a time step of one minute primarily to calculate the number of times the heat pump cycles ON and OFF. A new methodology to calculate this cycling process based on a 10 minute or hourly time step would cut down on simulation time considerably.

Another idea that can be explored for future work is BLAST ability to simulate the fan system with a ground loop and a boiler/cooling tower plant. In practice, a cooling tower is sometimes used to replace part of the ground loop in cooling dominated systems. This cuts considerably on the ground loop size.

Of course the boiler/ cooling tower have costs too, but their size would be small compared to the ones that would serve the building without the ground loop. A good part of the cost of a ground loop heat pump system is the digging and installation of the ground loop. So a smaller size ground loop would cut considerably on that big initial cost. Such a study might open new ways for cheaper ground loop heat pump systems.

Finally recall that one of the biggest limitations of this project is the time step used in GLHESIM. An hourly ground loop simulation model would definitely produce more accurate and useful results. BLAST runs hourly simulations producing hourly loads that could be fed to such a ground loop model. This would give the user the ability to study the hourly boreholes response to peak loads, the precise interaction between the water loop heat pump system performance and the ground loop fluid temperature, as well as the effects of the heat pumps cycling on and off.

References

- Eskilson, P. 1987. *Thermal Analysis Of Heat Extraction Boreholes*, Lund Institute of Technology, Dep. Of Mathematical Physics, Lund, Sweden.
- Marshall, C. and J. D. Spitler. 1994. *Users guide of GLHEPRO*, School of Mechanical and Aerospace Engineering, Oklahoma State University, Stillwater, OK.
- Spitler D. Jeffrey. Private communication. 1995.
- Electric Power Research Institute. 1989. *Soil and rock classification for the design of ground-coupled heat pump systems field manual*, International Ground Source Heat Pump Association , Stillwater, Oklahoma.
- Lash, T. A. 1992. *Simulation and analysis of a water loop heat pump system*, Masters Thesis, University of Illinois at Urbana-Champaign, IL.
- BLAST. 1993. *Users Guide for the BLAST WLHPS Model*, BLAST Support Office, University Illinois at Urbana-Champaign, IL.
- Ingersoll, L.R., O.J. Zobel and A.C. Ingersoll. 1954. *Heat conduction with engineering, geological, and other applications*. New York: Mc Graw-Hill.
- Kavanaugh S.P. and J.D. Deerman. 1991. *Simulation of vertical U tube ground coupled heat pump system*, ASHRAE Transactions, Volume 97, pages 287 - 295.
- Bose J.E. 1984. *Closed loop ground coupled heat pump design manual*. Oklahoma State University, Stillwater, OK.
- David Yeung kwok-wai Dec 1995, *Enhancements to a ground loop heat exchanger design program*, Masters Thesis , Oklahoma State University, Stillwater, OK.

APPENDICES

APPENDIX A

STRUCTURAL DETAILS OF THE WATER LOOP HEAT PUMP SYSTEM SUBROUTINE

STRUCTURAL DETAILS OF THE SUBROUTINE WLHPS IN BLAST

SUBMITTED TO : DR. SPITLER

SUBMITTED BY : SANI DAHER

DATE 20/3/95

INTRODUCTION :

This report has detailed description of the subroutine WLHPS.ftn. The first page has a figure showing in order all the subroutines called from the main subroutine WLHPS. The report explains in more details the steps and calculations carried out by each of the subroutines in Figure 1. A list of definitions of the variables may be found at the end of the report.

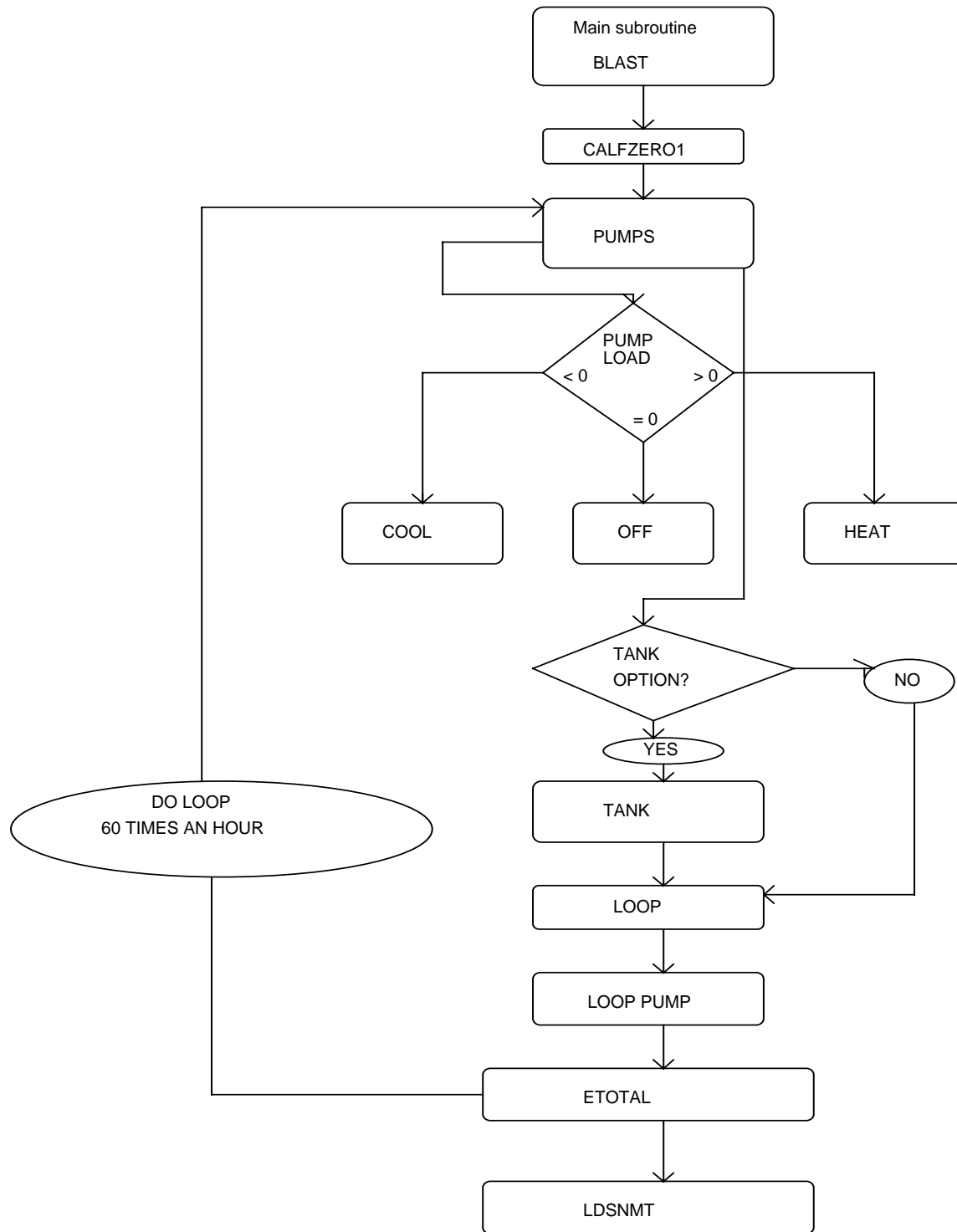

FIGURE 1. SUBROUTINES CALLED DURING RUNNING WLHPS IN BLAST

LIST OF VARIABLES :

ALPHA = NODAL LOOP MASS DIVISION (0-1)
ANN = ANNUAL SIMULATION KEEPER
BASECAP = INDIVIDUAL HEAT PUMP BASE CAPACITY (kW)
BASECOP = INDIVIDUAL HEAT PUMP BASE COP
BASEEER = INDIVIDUAL HEAT PUMP BASE EER
CONTROL = CONTROL OPTION FLAG (1-3)
CP = SPECIFIC HEAT OF WATER
CYCLETIME = COUNTER FOR THE CYCLING RATE OF EACH PUMP
CYCLE = # OF ON/OFF CYCLES PER HOUR
CYCLEFLAG = FLAG FOR HEAT PUMP CYCLING
COP = HEAT PUMP INSTANTANEOUS COP
CTRANS = TRANSIENT START-UP MULTIPLIER
DTHEXCH = TEMPERATURE RANGE FOR HEAT EXCHANGER
DENS20 = DENSITY OF WATER
EER = HEAT PUMP INSTANTANEOUS EER
EFFIC = LOOP PUMP EFFICIENCY (0-1)
EPUMPT,EPUMPP = INDIVIDUAL HEAT PUMP TOTAL AND PEAK
GAMMA = HEAT PUMP RUNTIME FRACTION
HCOP = HEAT PUMP COP PERFORMANCE PARAMETERS
HHCP = PERFORMANCE PARAMETERS FOR HEAT PUMP HEAT MODE
HEER = HEAT PUMP EER PERFORMANCE PARAMETERS
HEAD = WLHPS PRESSURE HEAD (EXCLUDING HEAT PUMPS)
HSCHED = SYSTEM ON OR OFF (1 OR 0)
LDINFO = ZONE LOAD
LPELECT,LPELECP = LOOP PUMP TOTAL AND PEAK
MLOOP = TOTAL LOOP MASS FLOW RATE (KG/S)
MASS = TOTAL LOOP MASS (KG)
MDOT = INDIVIDUAL HEAT PUMP FLOW RATE (KG/S)
MASSTANK = TOTAL STORAGE TANK MASS (KG)
MAXNZ = PARAMETER SETTING MAXIMUM # OF ZONES POSSIBLE
MBASE = BASE FLOW RATE FOR HEAT PUMP (KG/S/KW)
MN = MONTHLY COUNTER
NZONES = NUMBER OF ZONES (#HEAT PUMPS)
NTWKT,NTWKP = TOTAL AND PEAK PUMP NETWORK ENERGY
OFFCYCLE = THE TIME WHEN THE HEAT PUMP CYCLES DOWN
LOAD = LOAD ON THE LOOP FROM THE CENTRAL PLANT (KW)
PUMPPOWER = LOOP PUMP POWER (KW)
POW = HEAT PUMP POWER CONSUMPTION (kW)
PUMPELEC = HOURLY HEAT PUMP NETWORK ENERGY USAGE (kWh)
PRESS = INDIVIDUAL HEAT PUMP PRESSURE DROP
PRSURE = HEAT PUMP PRESSURE DROP PERFORMANCE PARAMETERS
PUMpload = LOAD SEEN BY HEAT PUMP (- COOL,+HEAT) (kWh)
QBOILER = TIME STEP LOOP HEATING LOAD (KW)

QCHILLER = TIME STEP LOOP COOLING LOAD (KW)
 QCHILLT = HOURLY LOOP COOLING LOAD (kWh)
 QPUMPT = INDIVIDUAL HOURLY HEAT PUMP ENERGY (kWh)
 QTCAP = INDIVIDUAL HEAT PUMP HOURLY CAPACITY TOTAL (kWh)
 QLPUMPT = HOURLY LOOP PUMP ELECTRIC USAGE (kWh)
 QHEATT = HOURLY LOOP HEATING LOAD (kWh)
 QPUMPS = LOAD ON THE LOOP FROM THE HEAT PUMP NETWORK (KW)
 QHEVP = ENERGY ABSORBED BY HEAT PUMP (HEAT MODE) (kW)
 QTANK = LOAD ON THE LOOP FROM THE STORAGE TANK (KW)
 QHNMT,QCNMT = HOURLY HEATING AND COOLING LOAD NOT MET
 QH = HEATING CAPACITY OF HEAT PUMP UNIT (kW)
 QEVAP = ENERGY EXTRACTED BY HEAT PUMP (HEAT MODE) (kW)
 QCOND = ENERGY ADDED BY HEAT PUMP (COOLING MODE) (kW)
 QCAP = INSTANTANEOUS PUMP CAPACITY (kW)
 QHCOND = ENERGY ADDED BY HEAT PUMP (COOL MODE) (kW)
 QC = COOLING CAPACITY OF HEAT PUMP UNIT (kW)
 RES = INDIVIDUAL HEAT PUMP RESISTANCE
 RTOTAL = HEAT PUMP NETWORK RESISTANCE
 SPECH20 = SPECIFIC HEAT OF WATER
 STEP = INTERNAL WLHPS TIME STEP (MIN.)
 SUPHLOADT,SUHHLOADP = SUPPLEMENTAL HEAT TOTAL AND PEAK
 SUPCLOADT,SUPCLOADP = SUPPLEMENTAL COOL TOTAL AND PEAK
 TA = INITIAL NODE1 TEMPERATURE FOR TIME STEP
 TB = INITIAL NODE2 TEMPERATURE FOR TIME STEP
 THIGH = MAXIMUM LOOP TEMPERATURE
 TLOW = MINIMUM LOOP TEMPERATURE
 TFIX = FIXED CHILLER/BOILER OUTLET TEMP.
 TRANSSTART = INDIVIDUAL HEAT PUMP TRANSIENT START COUNTER
 TWIN = PUMP NETWORK INLET TEMP. (NODE1)
 TWOUT = PUMP NETWORK OUTLET TEMP. (NODE2)
 TLMAX,TLMIN = HOURLY MAXIMUM MINIMUM NODE1 TEMPERATURE
 TNMAX,TNMIN = HOURLY MAX,MIN NODE2 TEMP.
 TREF = REFERENCE TEMPERATURE FOR PERFORMANCE CURVES (10 C)
 TPLANT = CENTRAL PLANT OUTLET TEMP
 TTANK = STORAGE TANK TEMPERATURE
 TTMIN,TTMAX = HOURLY STORAGE TANK MIN,MAX
 TTMN,TTMX = MONTHLY STORAGE TANK MIN,MAX
 TZONE = ZONE AIR TEMPERATURE
 TDB = AIR DRY BULB TEMPERATURE
 TWB = AIR WET BULB TEMPERATURE

DISCUSSION :

The subroutine WLHPS is called once every hour from the subroutine rout40.ftn. Once it is called, the subroutine performs all the steps below.

Step1:

Subroutine CALFZERO1 is called only once for initialization of variables.

1. The following variables are initialized in this subroutine:

TWIN, TWOUT, TLMAX, TLMIN, TNMAX, TNMIN, TTMIN, TTMAX, PUMPELEC, QCHILL, QLPUMPT, QHEAT, CYCLEFLAG, TRANSSTART, QTCAP, CYCLETIME, QPUMP

where TWIN, TWOUT are initialized as the TA, TB respectively, which are TWIN, TWOUT from the last iteration in the do loop. The rest of the variables are assigned numerical values that are overridden later on in the subroutine, as shown below.

2. Control is returned to WLHPS

Step2:

A do loop is started which performs the list of tasks, in step 3 through step 9, every minute, for 60 minutes each hour.

Step3:

The subroutine PUMPS is called, in which the following tasks, and calculations are performed:

1. Initialize the following variables for the heat pumps: QPUMPS, MLOOP, QHEVAP, CHCOND, QCAP

2. Determine the fraction of pumpload to its capacity for each pump (Pumpload is the load seen by the heat pump whether it is cooling or heating load). GAMMA(I)

3. Determine the number of cycles (on/off), of each heat pump, depending on the fraction of pumpload to pump capacity (GAMMA(I)), more specifically, if GAMMA(I) is around 0.5 then the number of cycles is equal to 3, and as GAMMA drifts away from 0.5 to either one or zero, the number of cycles drop to 1.

4. Calling three different subroutines for each pump depending on pumpload as follows:

A. If pumpload is positive, then the subroutine HEAT(I) is called. This subroutine calculates the following:

1. The heating capacity of the heat pump QH.
2. Energy extracted by heat pump QHEVP.
3. Pump power consumption POW
4. The following variables are calculated as well, TBD, QCAP, MDOTV(I), CTRANS.

B. If pumpload is negative, then the subroutine COOL(I) is called. This subroutine calculates the following:

1. The cooling capacity of the heat pump QC.
2. Energy added by the heat pump (cooling mode) QHCOND.
3. Heat pump power consumption POW.
4. The following variables are calculated as well, TWB, QCAP,MDOTV(I), CTRANS.

C. If pump load is zero, the subroutine OFF(I) is called. This subroutine basically turns the heat pump off by setting the following variables equal to zero. (QCAP, QHEVAP, POW,MDOTV)

5. If load is met, the heat pump is turned off by calling the subroutine OFF(I).

6. If pump should cycle off, then the subroutine OFF, is called to turn it off, and the counter for the cycling time is updated, for each pump.

7. Sum up the total power, and heat transfer, using the following variables: QPUMPS, QTCAP, MLOOP.

8. Increment the transient start up counter.

9. Return controls to main subroutine WLHPS.

Step 4:

The subroutine plants is called, in which the following tasks are performed:

1. Calculating load on the loop from the central plant , PLOAD according to type of control selected (See page 22 of the Water Loop Heat Pump System User's Guide).

NOTE: PLOAD later becomes QBOILER, or QCHILLER depending on whether PLOAD is positive or negative.

A. If control =1, PLOAD is calculated assuming, there is a fixed loop temperature, supplied by the user.

B. If control = 2, PLOAD is calculated assuming the loop temperature may float between TLOW, THIGH.

C. If control = 3, PLOAD is calculated assuming the loop temperature may float between TLOW, THIGH. The difference between control 2 and 3 is in the cycling (ON/OFF) process, in the first case, control = 2, the cycling is strictly a function of the temperature limits, while in the other case the cycling also depends on the net heating or cooling in all the zones so far.

D. If control = 4, PLOAD is calculated based on daily schedule of the loop temperature supplied by the user.

2. The following variables are also calculated in this subroutine. (WLPTWELL, WLPTWPMP)

3. Control is returned to main subroutine WLHPS.

Step 5:

A check is made on whether the option tank was used in the water loop design or not.

Step 6:

If the tank option was used, the subroutine WLHPTANK is called, in which the following tasks are performed.

1. The mass of the water in the tank needed is calculated MASSTANK (Every minute).

2. The load on the loop from the tank is calculated QTANK. More specifically it is a function of the tank temperature, the pump network outlet temperature and the temperature range in the heat exchanger as reflected by the following equation

$$QTANK = MLOOP * SPECH20 * (TTANK - TWOUT + \text{or} - DTHEXCH)$$

The sign in front of DTHEXCH depends on whether TWOUT > TTANK or not. If TWOUT > TTANK then the sign is positive.

3. The tank storage temperature is calculated TTANK.

4. Control is returned to the main subroutine WLHPS.

Step 7:

The subroutine LOOP is called, in which the following tasks are performed;

- 1. The initial time step node 1 (See figure 2 below) temperature is calculated TWIN.
- 2. The initial time step node 2 (See figure 2 below) temperature is calculated TWOUT.
- 3. Control is returned to the main subroutine WLHPS.

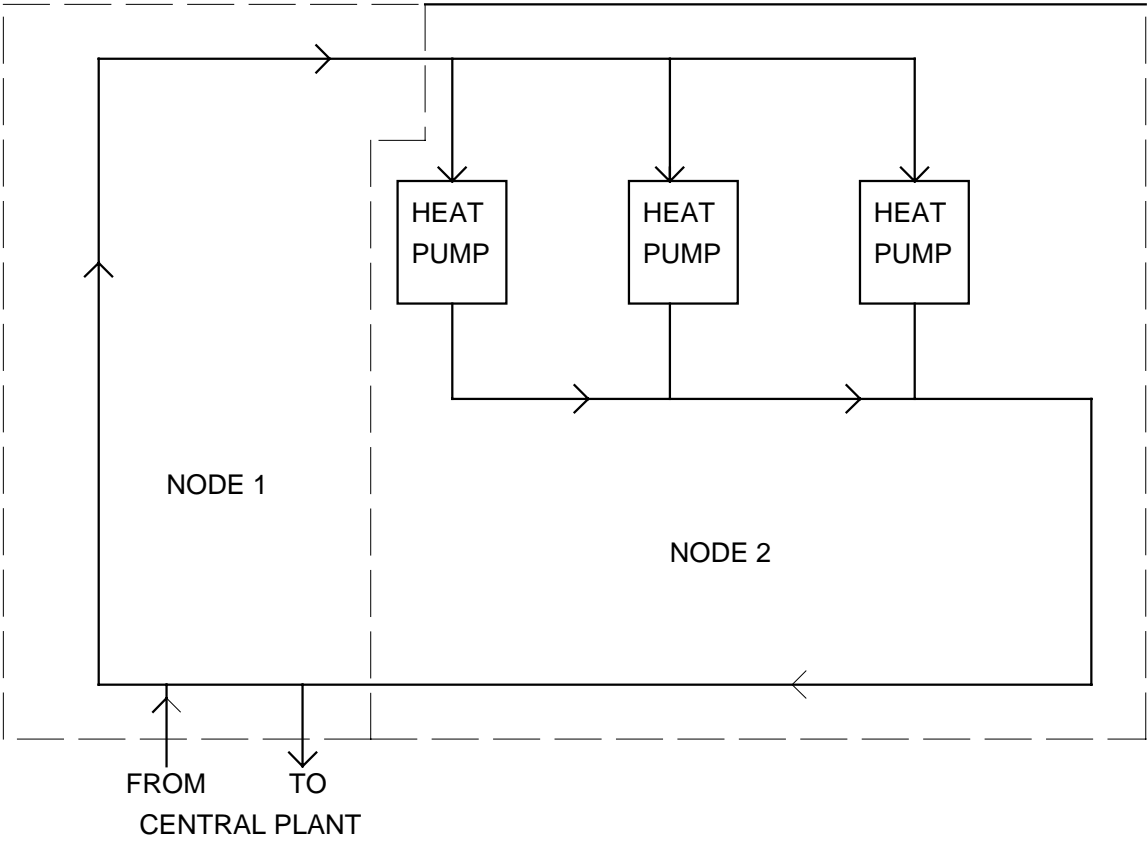

FIGURE 2. HEAT PUMP SYSTEM NODES

Step 8:

The subroutine LOOPPUMP is called in which the following tasks are performed;

1. A do loop is started to include all zones.
2. Individual heat pump pressure drop is calculated PRESS(I).
3. The pressure drop is converted into a resistance term RES(I).
4. The heat pump network resistance is calculated RTOTAL.
5. The loop pump power required is calculated PUMPPOWER.
6. Control is returned to the main subroutine WLHPS.

Step 9:

The subroutine ETOTAL is called, in which the following tasks are performed:

1. The hourly loop heating load is calculated by adding the loads for every minute QHEATT.
2. The hourly loop cooling load is calculated by adding the loads for every minute QCHILLT
3. The hourly loop electric usage is calculated.
4. The following variables are also calculated ETOWER, ETOWRP, ETOWRT.
5. See the definition of TWIN, TWOUT, TLMAX, TLMIN, TNMAX, TNMIN, TTMAX, TTMIN, TTMN, TTMX. In this step these maximum, and minimum limits are updated if they are exceeded by TWIN, TWOUT as follows:

- A. If $TWIN < TLMIN$ set $TLMIN = TWIN$
- B. If $TWIN > TLMAX$ set $TLMAX = TWIN$
- C. If $TWOUT < TNMIN$ set $TNMIN = TWOUT$
- D. If $TWOUT > TLMAX$ set $TNMAX = TWOUT$
- E. If $TWIN < TLMN$ set $TLMN = TWIN$
- F. If $TWIN > TLMX$ set $TLMX = TWIN$
- G. If $TWOUT < TNMN$ set $TNMN = TWOUT$
- H. If $TWOUT > TNMX$ set $TNMX = TWOUT$

6. Average temperatures are calculated as follows:

- A. $TNAVG = TNAVG + TWOUT*(STEP/60)$
- B. $TLAVG = TLAVG + TWIN*(STEP/60)$

7. The maximum and minimum tank temperatures are updated as follows:

- A. If $TTANK < TTMIN$ set $TTMIN = TTANK$
- B. If $TTANK > TTMAX$ set $TTMAX = TTANK$
- C. If $TTANK < TTMN$ set $TTMN = TTANK$
- D. If $TTANK > TTMX$ set $TTMX = TTANK$

8. The average tank temperature is calculated according to the following equation:

$$TTAVG = TTAVG + TTANK * (STEP/60)$$

9. Control is returned to the main subroutine WLHPS.

Step 10:

Continue the do loop, for the sixty minutes.

Step 11:

The subroutine LDSNMT is called, to calculate the unmet loads by the system as follows:

- 1. QHNMT, QCNMT are calculated.
- 2. Return controls to the main subroutine WLHPS.

This completes the run of WLHPS.

A FINAL WORD:

During my study of this subroutine there was a couple of things I could not interpret, but I didn't want to get stuck on it and waste my time, for I believe they are of minor importance to our work. However for completeness, I should mention them:

1. In almost every subroutine including the main WLHPS subroutine the following statement appeared, I could not figure out what it did.

IF (TRATIM) CALL ('NAME OF SUBROUTINE CURRENTLY IN', 1 or 2)

2. I could not identify the variable CTOWER, which is somehow related to the controls.

Finally, the following subroutines, though listed under WLHPS, were not called anywhere, in the execution of WLHPS:

1. Subroutine CALFZERO2 which is used to initialize the monthly maximum and minimum tank temperature, along with the initialization of other variables. This subroutine is called from the subroutine rout35.ftn, which is an OFF - ON clock for the fan system.

2. Subroutine CALFVENT ,called from rout40.ftn (Fan simulation subroutine), which does the ventilation simulation through the following steps:

A. Gets temperature for cooling and heating coils by calling CCTEMP, HCTEMP.

B. Gets entering mass for cooling and heating coils by calling CCMFR HCMFR.

C. Simulate cooling coil by calling CCOIL.

D. Simulate heating coil by calling HCOIL.

E. Check unmet loads for each zone.

Note CALFVENT is called only if HSCHED for it equals 1 for that hour.

3. Subroutine HPUMPINT which initializes performance parameters of heat pumps is called from rout6.ftn which reads user input from the simulation input file.

4. The subroutines RECWLHPS, RPTWLZL, RPTCALF, RPTWLZL which have to do with the report writer.

APPENDIX B

DETAILED EXPLANATION OF ALL CHANGES MADE IN THE CODE

DISCUSSION OF MODIFICATIONS IN THE BLAST CODE:

Besides adding GLHESIM.ftn and the other files used by this subroutine, there were several files from BLAST that were modified. The files are REPORT.inc, BLD1.ftn, WLHPS.ftn, GLHESIM.ftn, ROUT40.ftn and ROUT35.ftn. All modifications in the code are marked with MODSD marks. Each deck modified is going to be discussed separately in the sequence just listed. Starting with the REPORT.inc file where this project variables were declared. For a brief summary of the changes, see the section in the thesis concerning the implementation of the methodology in chapter 2. This long discussion of the changes is meant for persons interested in developing or changing this part of the software.

In REPORT.inc :

After consulting with the BLAST office, we were granted permission to use this file to declare the variables needed to be in common with all the files used for this project. Below is a cut and paste of the variables added.

C	The following logicals are with the ground loop simulation	MODSD
	LOGICAL glhpconv	modsd
	COMMON glhpconv	MODSD
	LOGICAL CHECKCONV	MODSD
	COMMON CHECKCONV	
	MODSD	
	LOGICAL LASTYEAR	MODSD
	COMMON LASTYEAR	MODSD
	LOGICAL FIRSTTIME	MODSD
	COMMON FIRSTTIME	MODSD
	COMMON SIMYEAR,ITT	MODSD

C

The variable glhpconv, is a logical variable that is true only for the first simulation, and is then changed into false, until temperature convergence has been reached for all the years. The second variable CHECKCONV, is another logical, used primarily by the ground loop simulation deck. It is a part of a smart guess algorithm for the loads from one year to the next. See the GLHESIM.ftn deck for more explanation. The Variable FIRSTTIME, is a logical used to indicate that the deck GLHESIM.ftn has been used for the first time. My goal all through this project was to keep the CPU time optimized. This variable insures that all input files are read only once during the iterations. The variable SIMYEAR keeps track of the year being simulated at that moment in time. LASTYEAR is the variable that indicates weather the LASTYEAR is being simulated or not. Finally the variable ITT keeps track of how many iterations it takes a particular year to get temperature convergence.

In BLD1.ftn :

All the variables you have seen in REPORT.inc are initialized here, to perform the tasks mentioned above.

```
c  glhpconv is the variable for the ground loop simulation
DATA glhpconv /.true./                                MODSD
C  The next three logicals and variable are for the ground loop
DATA CHECKCONV /.true./                                MODSD
DATA LASTYEAR /.false./                                MODSD
DATA FIRSTTIME /.true./                                MODSD
DATA SIMYEAR,ITT /1,0/                                  MODSD
```

Next in line are the modifications in WLHPS.ftn. That is the deck that has all the subroutines of the water loop heat pump system. The modifications have been cut and pasted here in the sequence they appear in the file.

In WLHPS.ftn :

Modification # 1:

```
INCLUDE 'report.inc'                                  MODSD
INTEGER K,K1,ITT,N                                    MODSD
```

These modifications appear in the subroutine PLANTS. The report.inc include statement is added to make the variables added there common between this and the rest of the files used for this project. In the integer statement, the variable N was added to be used as the counter for the monthly temperature array.

Modification # 2:

```
REAL TFX(12)                                          MODSD
OPEN (UNIT=5,FILE='tfx.dat',STATUS='OLD')            MODSD
```

These modifications are in subroutine PLANTS. TFX is the monthly fixed temperature array. The second statement opens the file that has the temperatures from the ground loop.

Modification # 3:

```
C This loop initializes the loop temperatures to 69F or 20C F, for the first
C Iteration, then it uses temperatures generated by GLHESIM      MODSD
C
```

```

IF(ghpconv) THEN
    DO 45 N=1,12
        IF(UNITS) THEN
            TFX(N)=69.
        ELSE
            TFX(N)= 20.56
        ENDIF
        WRITE(5,*) TFX(N)
45  CONTINUE
    GO TO 55
    ENDIF
MODSD
MODSD
MODSD
MODSD
MODSD
MODSD
MODSD
MODSD
MODSD
MODSD
MODSD
MODSD

```

The preceding is in subroutine PLANTS. Just as the comment say this is used to initialize the loop temperature, only for the first iteration, after which the calculated temperatures from GLHEPRO would be used. Note that these temperatures are written in the file tfx.dat, so we can retrieve them later for convergence check. The variable ghpconv is a logical variable. It is set to TRUE only for the first iteration, then stays FALSE until all years have been simulated and temperatures have reached convergence. Note the first calculations of the load uses a guess that the loop temperature for the whole year is 69 F. The plan was to change that later on, but from the results of the simulations, it was realized that the initial guess is not all that important. Convergence regardless of the initial guess converges very quickly as you will see later on and a 69 F initial guess was the best of such guesses.

Modification # 4:

```

C   this loop reads the monthly loop temperatures and converts to
C   SI units, if necessary (BLAST has all calculations in SI)
C
    DO 50 N=1,12
        READ (5,*) TFX(N)
50  CONTINUE
55  DO 62 N=1,12
        IF (UNITS) THEN
            TFX(N)=((TFX(N) + 459.67)/1.8) - 273.15
        ENDIF
62  CONTINUE
MODSD
MODSD
MODSD
MODSD
MODSD
MODSD
MODSD
MODSD
MODSD

```

This modification is in subroutine PLANTS. After the first iteration, the temperatures are read from the file and converted to SI units if they are in English units, since BLAST does all calculations in SI units.

Modification # 5:

```

IF(CONTROL.EQ.1) THEN
    PLOAD = MLOOP * 4.19 * (TFX(MONTH)-TWOUT)
    IF (PLOAD.GT.0.00001) GOTO 100
MODSD

```

```

TSET=AMAX1(TFX(MONTH),(OWB(IHOUR)+3.5))
IF (TWOUT.LT.TSET) TSET=TWOUT
MODSD

100 IF (CONTROL.EQ.1) THEN
TPLANT=TFX(MONTH)
PLOAD = MLOOP*4.19*(TPLANT - TWOUT)
MODSD
C   WRITE(*,*) MONTH,TFX(MONTH)
MODSD
IF (PLOAD.GT.0.0001) THEN
QBOILER = PLOAD
ELSE
QCHILLER = PLOAD
ENDIF
ENDIF
ENDIF

```

These modifications are in subroutine PLANTS. The only changes made here is the use of the monthly temperatures instead of the one yearly one. The counter MONTH is used to increment the temperatures array. So for example, for month 5 the fifth temperature in the array is used for the calculation. Note control 1 is used here. That control used to correspond to the one yearly fixed loop temperature control. The BLAST office needs to create a control 5 for this purpose and incorporate it into their parser.

Modification # 6:

```

CLOSE(5)
MODSD

```

This statement closes the tfx.dat file.

Modification #7:

```

INCLUDE 'report.inc'
REAL CNVE
MODSD
MODSD

```

This modification is in subroutine RECWLHPS. These two statements were added, to define the variables that will be used later on. CNVE is a function from the BLAST code that does load conversion from SI to English units, only if necessary.

Modification # 8:

```

OPEN(UNIT=7,FILE='loads.dat',STATUS='OLD')
DO 722 MON=1,12
MODSD
c---- write out to loads file in user units system
MODSD
WRITE(7,*) cnve(SUPHLOADT(MON)*1000.0),
MODSD
&          cnve(SUPCLOADT(MON)*1000.0)
MODSD
722   CONTINUE
MODSD
CLOSE(7)
MODSD

```

These lines were also added in RECWLHPS. In this subroutine the loads are summed for each month. The heating and cooling loads are stored in the variables SUPHLOAD and SUPCLOAD respectively. These loads correspond to the loads, on the Boiler and Chiller respectively. Thus in our case these are the Ground loop loads. The loads are converted to English units, if the user specified English units in the BLAST input file. They are then written into the file loads.dat for use in GLHESIM.ftn

Modification # 9:

```
C
      CALL glhesim                                MODSD
103   CONTINUE
C
```

This modification is the last in WLHPS.ftn. Once the loads have been written to the file, a call to glhesim is made to start the ground loop simulation.

These are all the modifications done in WLHPS.ftn. In brief, an initial guess at the loop temperatures is made. Based on these temperatures the loop loads are calculated and transferred to the ground loop simulation subroutine. The next time around, or the next iteration the loop temperatures from the ground simulation is used.

In GLHESIM.ftn :

GLHESIM.ftn is the deck from the GLHEPRO program. It does the ground loop simulation, given the yearly loads and information about the soil and the circulating fluid, along with the ground loop configuration and size. The loads are passed to GLHESIM.ftn during execution. It then calculates loop temperatures and checks for convergence with the assumed temperatures used in WLHPS.ftn. Below is a discussion of all the modifications. Through the discussion of these modifications is a step by step explanation of the iteration process.

Modification # 1:

```
      SUBROUTINE glhesim                                MODSD
```

Subroutine GLHESIM is added into BLAST as a separate Deck (GLHESIM.ftn). Note all the changes are marked by MODSD. A couple of general notes need to be mentioned before we go any further. The subroutine INTERP was renamed to XINTERP, due to conflict with one of BLAST's variables and the include statements all through the program were slightly modified to run on the Apollo work station.

Modification # 2:

```

IMPLICIT REAL (A-Z)
INTEGER NPAIRS,TPRINT,TPRINT1,TPRINT2,MONTHS,I,ITER,IM,Y,
& MONTHmin,MONTHmax,FRTMONTH,LSTMONTM,NOYEARS,SIMYEAR,A,ITT
MODSD

PARAMETER (MONTHS=300)
DIMENSION LNTTS(25), GFNC(25),TOUTLD(0:12) MODSD
dimension qheat(0:12),qcool(0:12),qheatin(0:12),qcoolin(0:12), MODSD
&
ELECTRIC(0:MONTHS),HTGROUND(0:MONTHS),QN(0:MONTHS),QC(0:MONTHS),
& EWT(0:MONTHS),TF(0:MONTHS),Tin(0:MONTHS),Tout(0:MONTHS),
& QH(0:MONTHS),c_rej(3),powcool(3),c_abs(3),powheat(3)

CHARACTER*27 GFILE
CHARACTER*50 HEADER
CHARACTER*4 CONVERGE
CHARACTER*12 OUTFILE

INCLUDE 'convert.inc'
INCLUDE 'report.inc'

```

These lines of code are under the main subroutine of the GLHESIM.ftn deck. The variables FRTMONTH, LSTMONTM, NOYEARS, SIMYEAR, A, and ITT were declared. The use of each these variables and others will be discussed later. In the dimension statements all these arrays were changed to the number of months, the user want simulated, instead of 300 months. Note the Maximum size of these arrays is still 300. That change came about to accommodate other changes made in the results printout. The array TOUTLD is added here to hold on to the old temperatures, for the convergence check. Finally the REPORT.inc file is added, and the convert.inc statement was just modified for the Apollo work Station. Convert.inc is a file that comes with GLHESIM.

Modification # 3:

```

OPEN (UNIT=16,FILE='tfx.dat') MODSD
OPEN (UNIT=12,FILE='glhedata.dat',STATUS='OLD')
OPEN (UNIT=14,FILE='results.out')
CHECKCONV= .true. MODSD
Tmin=500.0
Tmax=-500.0

CALL READGLHEDAT(H,RADb,K,Cground,Cfluid,Tom,Rb,Mdot,RHO,
& GFNC,GPM,QHEAT,QCOOL,
& c_rej,powcool,c_abs,powheat,OUTFILE,bh,
& qheatin,qcoolin,FRTMONTH,LSTMONTM,NOYEARS) MODSD

```

The first statement opens the temperatures file. The second reinitializes the variable CHECKCONV to TRUE. The last one calls the subroutine that reads the data file. The variables FRTMONTH, LSTMONTH, NOYEARS are assigned numerical values in that subroutine.

Modification # 4:

```
C   THE variables TPRINT1 and TPRINT2 were changed to simulate a year
C   at a time, instead of all the months together in one time.
      TPRINT1 = 1                                MODSD
      TPRINT2 = 12*SIMYEAR                       MODSD
```

The variables TPRINT1, TPRINT2 used to be(as in the GLHEPRO program) the first and last months to be simulated. In this new code TPRINT1 is always the first month, and TPRINT2 is the number of months to be simulated. Note that TPRINT2 is strictly a multiple of twelve.

Modification # 5:

```
      OPEN (UNIT=1, FILE='outfile')              MODSD
```

This open statement used to have a unit that was used by the BLAST program. Since the outfile needs to be open all through the simulations and iteration procedure, the unit was changed to 1 all through this deck.

Modification # 6:

```
      CALL READGFNC(LNTTS,GFNC,NPAIRS,GFILE,NB,HEADER)
C   outfile is printed to only at the beginning of the simulation and MODSD
C   then incremented with the temps of each year upon convergence. MODSD
      IF (FIRSTTIME) THEN                                MODSD
      CALL PRINthead(H,RADb,K,Cground,Cfluid,Tom,Rb,Mdot,RHO,HEADER,
      &          GFILE,GPM,qheatin,qcoolin)              MODSD
      FIRSTTIME=.false.                                MODSD
      MODSD
      ENDIF
      MODSD
```

As the comment here says, the outfile initial data is only printed once, and then incremented every time results for one simulated year is finished. This was also done to optimize CPU time.

Modification # 6 :

```
QN(TPRINT)=HTGROUND(TPRINT)/(NB*H)              MODSD
```

This statement used to have the function FLOAT in front of the integer NB, but on the Apollo, that had to be removed, otherwise the compiler complained. It was verified that this equation returned the same value without the FLOAT function.

Modification # 7 :

C	The next few lines take the last 12 months of simulation from the	MODSD
C	arrays and puts it in at the beginning for print out.	MODSD
1240	IF (SIMYEAR.NE.1) THEN	MODSD
	DO 520 A=1,12	MODSD
	EWT(A)=EWT(((SIMYEAR-1)*12)+A)	MODSD
	QN(A)=QN(((SIMYEAR-1)*12)+A)	MODSD
	TF(A)=TF(((SIMYEAR-1)*12)+A)	MODSD
	TIN(A)=TIN(((SIMYEAR-1)*12)+A)	MODSD
	ELECTRIC(A)=ELECTRIC(((SIMYEAR-1)*12)+A)	MODSD
520	CONTINUE	MODSD
	ENDIF	MODSD

All this is still under the main subroutine of GLHESIM. When simulating any year other than the first one, the temperature array grows to the number of years multiplied by twelve. The last 12 months is the year, we are interested in. So for purposes of print out and convergence check these twelve months variables are brought to the front of the array using the few lines above.

Modification # 7 :

C	This if statement is here to bypass the convergence check if temperatures	
C	for a new year has just been computed.	MODSD
C		
	IF (CHECKCONV) THEN	MODSD
	goto 1242	MODSD
	ELSE	MODSD
	glhpconv= .false.	MODSD
	REWIND (UNIT=16)	MODSD
	DO 1241 A=1,12	MODSD
	IF (UNITS) EWT(A)=TDEGF(EWT(A))	MODSD
	WRITE (16,*) EWT(A)	MODSD
1241	CONTINUE	MODSD
	goto 1250	MODSD
	ENDIF	MODSD

This simple algorithm provides a smart quick calculation of the expected temperatures for a new year. Say for example convergence for year five has just been reached. Instead of using year 5 temperatures to calculate new loads and then go into GLHEPRO only to find that due to heat build the temperatures for the new year, year 6, have changed slightly and the program has to

reiterate, a smart guess for year six temperatures is made. The smart guess is, the loads from year 5 are carried on to year 6 and GLHESIM runs again to create temperatures for year 6. These temperatures are then used to calculate the loads in BLAST, and then the new temperatures from GLHEPRO using these loads are checked with our guess. From the many simulations executed, this proofed to cut CPU time by about 5 - 20 % regardless of the input file. In fact for semi balanced loads, convergence is always reached without iterating at all. In the previous methodology an extra iteration was inevitable for every new year.

Modification # 7 :

```
C
1242 CALL CONVRGNG(EWT,TOUTLD)                                MODSD
```

C

The following statement calls the subroutine added to GLHESIM. This Subroutine checks for convergence of the loop temperatures and returns the logical variable glhpconv value accordingly.

More about this subroutine later on.

Modification # 8 :

```
C The following if statement is a check if convergence has just been
C reached for that year and whether there are more years to simulate.
C
IF (.not.(LASTYEAR).AND.(glhpconv)) THEN                                MODSD
ITT=0                                                                    MODSD
SIMYEAR=SIMYEAR+1                                                        MODSD
WRITE(*,1243) SIMYEAR                                                    MODSD
1243 FORMAT (2X,' NOW SIMULATING YEAR ',I3)                               MODSD
CALL OUTPUT(QN,TF,TIN,EWT,ELECTRIC)                                       MODSD
CHECKCONV= .false.                                                        MODSD
goto 1                                                                    MODSD
ENDIF                                                                      MODSD
```

The above checks if convergence for the current year has been reached, if so and the current year is not the last one, then the counter SIMYEAR is incremented, so calculation for the next year is started. The statement, Year N is now being simulated, is printed to screen. The OUTPUT subroutine is called to print the converged temperatures to the outfile. The variable CHECKCONV is turned into FALSE. This is part of the smart guess of the loop temperatures for the new year. (See modification # 7) The statement goto 1 starts the new GLHESIM calculations, this time for one more year since the SIMYEAR counter has been incremented. The temperature convergence check need not be done until the program goes through WLHPS.ftn again, that is the reason CHECKCONV was turned to FALSE.

Modification # 9 :

```

C   outfile is kept open until the last of the simulations results      MODSD
C   are written to it.                                                MODSD
  IF ((LASTYEAR).AND.(glhpconv)) THEN                                  MODSD
  CALL OUTPUT(QN,TF,TIN,EWT,ELECTRIC)                                MODSD
  CLOSE(UNIT=1)                                                       MODSD
  WRITE(*,*) ' NOW FINISHING UP'                                       MODSD
  ENDIF                                                                MODSD

1250 CONTINUE                                                         MODSD

```

In the above a check is made to see if convergence have been reached for the last year, if so the OUTPUT subroutine is called for the last time, and the statement NOW FINISHING UP is printed to screen. Unit 1, which is the outfile is closed. Note this is the only time that glhpconv is kept as TRUE as the program leaves the GLHESIM deck. This ensures that BLAST now does not call GLHESIM again, but continues to print its output file using the latest loads, thus showing the unmet loads for the last year of simulation.

Modification # 10 :

```

  IF (SIMYEAR.EQ.NOYEARS) LASTYEAR=.true.                            MODSD
  bhcenter=bh*H
  tot_len=H*NB

```

Each simulation this check is done until SIMYEAR equals the total number of years that the user specified in terms of months in the GLHEPRO input file. The logical LASTYEAR is then turned to TRUE.

Modification # 11 :

```

Cdel CALL RESULTS(HEADER,H,Tmin,Tmax,MONTHmin,MONTHmax,BHCENTER,
MODSD
Cdel &      TOT_LEN)
      CLOSE(UNIT=16)
      CLOSE(UNIT=12)
Cdel  CLOSE(UNIT=1)                                                  MODSD
      CLOSE(UNIT=14)

  RETURN
  END

```

The RESULTS subroutine, prints a short file that is used by GLHEPRO for a summary of the results. In our case this file is no longer used, so it can be taken out. Unit 1 is not closed until all years have been simulated, so the Unit 1 close statement needs to be deleted too. Again all these modifications are under the main subroutine in GLHESIM.ftn. Next are the modifications in the READGLHEDAT subroutine.

Modification # 11:

```
SUBROUTINE READGLHEDAT(H,RADb,K,Cground,Cfluid,Tom,Rb,
&      Mdot,RHO,GFILE,GPM,QHEAT,QCOOL,
&      c_rej,powcool, MODSD
&      c_abs,powheat,OUTFILE,bh,
&      qheatin,qcoolin,FRTMONTH,
&      LSTMONTH,NOYEARS) MODSD
```

```
LOGICAL UNITS MODSD
```

These statements are in the subroutine READGLHEDAT. The variables FRTMONTH , LSTMONTH, NOYEARS are defined in this subroutine, FRTMONTH is the first month of simulation, LSTMONTH, is the last month of simulation, and NOYEARS is the number of years to be simulated. UNITS is the variable from BLAST it is defined here, so that the GLHESIM units would correspond to the BLAST ones.

Modification # 12 :

```
OPEN(UNIT=15,FILE='LOADS.DAT') MODSD
c  read(12,116) GFILE MODSD
```

These modifications are made in the subroutine READGLHEDAT. The first statement opens the LOADS.DAT file that has the monthly Loads on the ground loop. These are the loads that were generated by BLAST. The second statement has been commented, because it is not needed here. It used to contain the directory the G-file was under. Right now the GFILE is under the same directory the users is working in. Note if the ground loop input file is generated using GLHEPRO, make sure to take that line out otherwise, it will cause a reading error. See file GLHEDATA.DAT for the Daycare center of chapter 3, and compare any new files with it. The BLAST office will make changes to the input file as they see necessary later on.

Modification # 13 :

```
IF(UNITS) THEN MODSD
  UNITSIN=1 MODSD
  UNITSOUT=1 MODSD
ELSE MODSD
  UNITSIN=2 MODSD
  UNITSOUT=2 MODSD
ENDIF MODSD
```

These modifications are under the subroutine READGLHEDAT. The units of GLHESIM are matched with the units of BLAST. These units apply for both the input and output files of

GLHESIM. So if the variable UNITS is true, i.e. English units, then both files input and output should be in English units, and vice versa..

Modification # 14:

```
C Notice you need both read statements to indent the GLHEDATA file
C Correctly, but the Loads are read from the LOADS.DAT FILE.      MODSD
C
  READ (12,130) qheatin(l),qcoolin(l)                            MODSD
  READ (15,*) qheatin(l),qcoolin(l)                              MODSD
```

These modifications are under the subroutine READGLHEDAT. In the first statement the variables were made into lower case ones, to match all through the program. Originally some were capital, other were lower case. On a PC, it does not make a difference but the Apollo is case sensitive. The second statement overrides these variables such that the loads are read from the LOADS.DAT file we generated earlier on. The first read statement is kept, so that the input file is indented correctly, because there are more variables to be read.

Modification # 15 :

```
READ (12,132) TEMP1
C TPRINT1=NINT(TEMP1)                                           MODSD
  FRTMONTH=NINT(TEMP1)                                          MODSD
  READ (12,134) TEMP2
C TPRINT2=NINT(TEMP2)                                           MODSD
  LSTMONTH = NINT(TEMP2)                                        MODSD

  NOYEARS = (LSTMONTH - FRTMONTH +1)/12                        MODSD
```

The original code used to read the first and last month of simulation and store them in TPRINT1, and TPRINT2. Well in this code since, the simulations have to be done in multiples of twelve months at a time, TPRINT1 and TPRINT2 values were changed to the constant values of one and twelve respectively. From the number of months, the number of years are calculated, and then one year after the other is simulated.

Modification # 16:

```
DO 10 I=1,12                                                    MODSD
  QN(I)=QN_IP(QN(I))
  TF(I)=TDEGF(TF(I))
Cdel TOUT(I)=TDEGF(TOUT(I))                                     MODSD
```

These statements are in the OUTPUT subroutine. The temperatures exiting the loop are no longer converted to SI units, because they already have been converted in the convergence check subroutine. So this statement is to be deleted.

Modification # 17 :

```
DO 20 I=1,12                                MODSD
  WRITE(1,100) I,QN(I),ELECTRIC(I),TF(I),TIN(I),TOUT(I)  MODSD
20  CONTINUE

100  FORMAT(1X,I4,2X,F10.2,2X,F10.2,2X,F10.2,2X,F10.2,2X,F10.2)

  RETURN
  END
```

These statements are also in the OUTPUT subroutine. In the original code the values of the loop temperatures, power consumption and electricity used to be printed all together for all the months. In this code, the temperatures are printed out every time a year results have been generated.

Modification # 18 :

```
qheatin(I)=qheatin(I)*1055.05585            MODSD
qcoolin(I)=qcoolin(I)*1055.05585            MODSD
```

The above statements are in subroutine PRINTHEAD. The variables have been changed to lower case to conform with the rest of the code.

Modification # 19 :

```
C  In all these write statements unit 13 is changed to unit 1
C  so there is no conflict with BLAST                                MODSD
  WRITE(1,100) HEADER                                                MODSD
  WRITE(1,*) ''
  WRITE(1,101) GFILE
  WRITE(1,*) ''
  WRITE(1,*) ''

  IF (IP_OUT) THEN
```

*** This is the header for output in I-P units:

```
WRITE(1,102) HTEMP
WRITE(1,104) RADbTEMP
```

```

WRITE(1,106) KTEMP
WRITE(1,108) CgroundTEMP
WRITE(1,109) CfluidTEMP
WRITE(1,110) TomTEMP
WRITE(1,112) RbTEMP
WRITE(1,116) GPM
WRITE(1,117) RHOTEMP
WRITE(1,*) ' '
WRITE(1,*) ' '
write(1,119)
write(1,120)
write(1,121)
write(1,201) qheatin(1),qcooln(1)
write(1,202) qheatin(2),qcooln(2)
write(1,203) qheatin(3),qcooln(3)
write(1,204) qheatin(4),qcooln(4)
write(1,205) qheatin(5),qcooln(5)
write(1,206) qheatin(6),qcooln(6)
write(1,207) qheatin(7),qcooln(7)
write(1,208) qheatin(8),qcooln(8)
write(1,209) qheatin(9),qcooln(9)
write(1,210) qheatin(10),qcooln(10)
write(1,211) qheatin(11),qcooln(11)
write(1,212) qheatin(12),qcooln(12)
WRITE(1,*) ' '
WRITE(1,*) ' '
WRITE(1,125)
WRITE(1,126)
WRITE(1,*) '*****'
      &'*****'
      ELSE

```

*** This is the header for output in SI units:

```

WRITE(1,140) H
WRITE(1,141) RADb
WRITE(1,142) K
WRITE(1,143) Cground
WRITE(1,144) Cfluid
WRITE(1,145) Tom
WRITE(1,146) Rb
WRITE(1,148) Mdot
WRITE(1,149) RHO
WRITE(1,*) ' '
WRITE(1,*) ' '
write(1,150)

```



```

write(1,151)
write(1,152)
write(1,201) qheatin(1),qcooln(1)
write(1,202) qheatin(2),qcooln(2)
write(1,203) qheatin(3),qcooln(3)
write(1,204) qheatin(4),qcooln(4)
write(1,205) qheatin(5),qcooln(5)
write(1,206) qheatin(6),qcooln(6)
write(1,207) qheatin(7),qcooln(7)
write(1,208) qheatin(8),qcooln(8)
write(1,209) qheatin(9),qcooln(9)
write(1,210) qheatin(10),qcooln(10)
write(1,211) qheatin(11),qcooln(11)
write(1,212) qheatin(12),qcooln(12)
WRITE(1,*) ' '
WRITE(1,*) ' '
WRITE(1,155)
WRITE(1,156)
WRITE(1,*) '*****'
      &'*****'
ENDIF

```

These statements are also in the subroutine PRINT HEAD, the Unit 13 was changed to Unit 1, because it conflicts with the BLAST code Unit 13.

Modification # 20 :

```

INTEGER I MODSD

```

This modification was done in the Subroutines HEATING and COOLING under GLHESIM. I believe this is straight forward.

Modification # 21 :

```

SUBROUTINE CONVRGNG(EWT,TOUTLD)

```

```

C*****
C*
C* SUBROUTINE: CONVRGNG
C*
C* LANGUAGE: FORTRAN
C*
C* PURPOSE: To test for convergence between the last set
C*           of groundloop outlet temperatures and the new
C*           ones. If convergence have been reached the
C*           results are printed out. Otherwise the new temperatures

```

```

C*      replaces the old ones, and control is returned
C*      to BLAST to run another iteration.
C*****
C*
C* COMMON VARIABLES:
C* IP_IN - A logical variable. Equal to .TRUE. for input data
C*      in IP units, .FALSE. for input data in SI units.
C* IP_OUT - A logical variable. Equal to .TRUE. for output data
C*      in IP units, .FALSE. for output data in SI units.
C*
C*****
C*
C* MAJOR ASSUMPTIONS: None
C*
C* DEVELOPER:      Sani Daher
C*                  Jeffrey D. Spitler, Ph.D., P.E.
C*                  Oklahoma State University
C*
C* DATE:           JUNE 10, 1995
C*
C* INCLUDE FILES:  CONVERT (GLHEPRO)
C* SUBROUTINES CALLED: REPORT.inc (BLAST)
C*
C* FUNCTIONS CALLED: TDEGF
C*
C* REVISION HISTORY: None
C*
C* REFERENCE:      Thermal Analysis of Heat Extraction
C*                  Boreholes. Per Eskilson, Dept. of
C*                  Mathematical Physics, University of
C*                  Lund, Sweden, June 1987.
C*
C*****
C*
C* INTERNAL VARIABLES:
C* TPRINT1 - integer; The first month that the user would
C*      like data for.
C* TPRINT2 - integer; The final month that the user would
C*      like data for.
C* TPRINT - integer; The range of months, from TPRINT1 to
C*      TPRINT2, that the user has requested.
C*
C*****
IMPLICIT REAL (A-Z)
      INTEGER I,L,ITT
      DIMENSION EWT(0:MONTHS),TOUTLD(0:MONTHS)

```

```
INCLUDE 'convert.inc'  
INCLUDE 'report.inc'
```

C

```
ITT=ITT+1
```

```
D=0.3
```

```
glhpconv = .true.
```

```
DO 10 I =1,12
```

```
READ(16,*) TOUTLD(I)
```

```
10 CONTINUE
```

C

C Converting to English units for convergence check

C

```
IF(UNITS) THEN
```

```
DO 15 I= 1,12
```

```
  EWT(I)=TDEGF(EWT(I))
```

```
15 CONTINUE
```

```
D=0.5
```

```
ENDIF
```

```
DIFF =0.0
```

```
WRITE(*,*) ITT
```

```
DO 20 I= 1,12
```

```
  write(*,*) TOUTLD(I), EWT(I)
```

```
  DIFF = ABS(TOUTLD(I)-EWT(I))
```

```
  IF (DIFF.GT.D) THEN
```

```
    WRITE(*,*) 'NEED TO DO ANOTHER ITERATION'
```

```
    REWIND (UNIT=16)
```

```
    glhpconv= .false.
```

```
    DO 30 L = 1,12
```

```
      IF (ITT.GT.3) THEN
```

C relaxing scheme after 3 iterations, to avoid the solution getting stuck

```
        WRITE(16,*) ((0.5*EWT(L))+0.5*TOUTLD(L))
```

```
      ELSE
```

```
        WRITE(16,*) EWT(L)
```

```
      ENDIF
```

```
30 CONTINUE
```

```
IF (ITT.EQ.30) THEN
```

```
  WRITE(*,*) 'SOLUTION DID NOT CONVERGE TRY A BIGGER BOREHOLE'
```

```
  glhpconv = .true.
```

```
ENDIF
```

```
goto 100
```

```
End If
```

```
20 CONTINUE
```

```
100 IF((glhpconv) .AND. (ITT .LT.30)) WRITE(*,50) (ITT-1)
```

```
50  FORMAT(2X,'CONVERGENCE HAS BEEN REACHED AFTER  
,I3,'ITERATIONS')  
110  RETURN  
    END
```

This is the subroutine that was added to GLHESIM to check for convergence. In the subroutine statement, the arrays EWT, and TOUTLD, are shared with this subroutine. EWT is the array that has the new set of loop temperatures. TOUTLD is the old set of temperatures.

First the variable ITT is incremented by one indicating that the program is about to check for convergence one more time. The logical variable glhpconv is changed to TRUE, and will then be changed to FALSE if temperatures did not converge. The old temperatures are then read from the file and converted to the appropriate units. The Do-Loop after that checks for convergence by comparing the respective new and old temperatures to a half of a degree Fahrenheit if working in English units or to 0.3 degrees Celsius if working in SI units. If the temperatures converged within this criteria the program returns to the main subroutine GLHESIM with glhpconv = TRUE. If convergence is not reached, the variable glhpconv is turned into FALSE, and the new temperatures replaces the old ones, in preparation for the new iteration.

However if the solution after 3 iterations has not converged yet then the relaxation scheme is applied and the new temperatures sent to BLAST are a combination of the old and new ones. This scheme drives the solution to convergence if the solution is getting stuck. A 0.5 °F convergence criteria is good for all practical purposes. So if it is decided later on to make the convergence criteria and the relaxation coefficient BLAST inputs. Then it is recommended to make the default value for the convergence criteria 0.5 °F and the relaxation coefficient as 0.5 or lower. Then the statement “try a bigger borehole ”should say “ try a larger convergence criteria with a slower relaxation scheme, if that does not work, use a bigger borehole.”

These comments must be added to one of the output files, or printed to the screen. If the user tries an underdesigned borehole, then the temperatures might indeed not converge and the user should be informed about his options. It is important to understand the meaning of a 0.5 °F convergence criteria. When the temperatures converge within that criteria, that means the loads of operating the heat pumps were modeled with that accuracy. So if the temperatures converge within 0.5 or 1.0 °F, it will not make all that much difference on the overall results. However it is important to know that the temperatures converged within some convergence criteria so that a limit on the error of calculating the heat pump power usage is set. For a convergence criteria of up to 1 °F, this error is negligible.

The Variable ITT keeps track of the number of iterations. If the number of iteration is greater than thirty, then the statement about choosing a bigger borehole is printed out. Note all the write statements added are temporary and are only here for monitoring the simulation process. It is to the BLAST office to add these comments in the output file of BLAST, rather than to the screen if they prefer to do so.

These are all the modifications done in GLHESIM.ftn, this brings us to the file Rout40.ftn.

In ROUT40.ftn :

This BLAST file handles the loops involved in calculating the building, fan system, and central plant loads. The fan system loop was modified in such a way as to reiterate through the fan system calculations, if the temperatures of the loop did not converge, or the program is simulating a new year.

```
300 Continue MODSD
CD$__ DO INITIAL SYSTEM?S CALCULATIONS
CALL AHSIZE
C set beginning of simulation flag for printing RW header MOD148
RPFLAG=.TRUE. MOD148
CD$__ BEGIN DAY LOOP
C THE FOLLOWING MODS WERE MADE TO AID IN PORTING TO 386 MACHINES
MOD104
CREP DO 500 CURDAY = 1,NRDAY$ MOD104
DO 500 L1 = 1,NRDAY$ MOD104
CURDAY=L1 MOD104
CD$__ GET DAILY ENV AND ZONE LOAD INFO
CRGEN RPFLAG=DEFRPT
CDEL RPFLAG=.FALSE. MOD148
CALL RDZLI(RPFLAG)
C call the Report Writer Block Header printing routine MOD148
IF (RWSFLG .AND. RPFLAG) CALL RWBHDR(2,2,RWUNIT(NOENV))
MOD148
RPFLAG=.FALSE. MOD148
CD$__ SIMULATE DESIRED SYSTEM
CALL SIMAHS(RPFLAG)
CD$__ END DAY LOOP
500 CONTINUE

c this is a heat pump iteration on annual run test case MODSD
if(.not. glhpconv) then
l=l+1 MODSD
CD$__ READ IN /EFLHDR/ modsd
IOCMND = RDCMND modsd
FILTYP = SIMST modsd
RECTYP = FHENVH modsd
FHENV = NOENV modsd
BUFILL = NO modsd
CALL FHSUP(0.0,1) modsd
IF (IOFLAG.EQ.FAILUR) CALL ERROR2 modsd
```

```

- ('ERROR IN READING ENV HEADER IN SIMSYS',3)          modsd
C
  Goto 300                                             MODSD
  End If                                              MODSD
CD$__          GENERATE SYSTEM REPORTS
  CALL RPTGEN(NOENV,NUMENV)

```

The above is another cut and paste from ROUT40.ftn. As you see from the code the system loop runs for the whole year, then a check on the logical variable glhpconv is done. If glhpconv is FALSE, as it would be when the temperatures do not converge or another year is being simulated, another iteration through the fan system is started. The statements right after the IF statement, are for resetting some file pointers in BLAST, so that the program can run the Fan System simulation again. On the other hand if glhpconv = TRUE then BLAST continues to print out the reports and finish up as before.

In Rout35.ftn :

The changes below serves one goal. It skips the re-initialization of loop temperatures if the ground loop simulation is running another year. This way the last hour temperatures of last year apply to the first hour of the coming year. Also in the BLAST output reports the monthly maximum and minimum temperatures entering and exiting the heat pump, would now become the maximum and minimum over the whole period of simulation instead of the last year of simulation.

```

INTEGER SIMYEAR                                     MODSD

HPCPWR = 0.0                                       MOD144
c  this is to bypass reinitilization if GLHEPRO is running for the second
c  or more years.                                  MODSD
  IF(SIMYEAR.NE.1) GOTO 14                          MODSD
CD  WRITE(*,*) SIMYEAR,SIMYEAR                     MODSD
  TA = TLINITIAL                                    MOD194
  TB = TLINITIAL                                    MOD194
  TTANK = TTINITIAL                                 MOD194
  DO 13 K=1,13                                     MOD194
  TNMX(K) = TLOW                                    MOD194
  TNMN(K) = THIGH                                   MOD194
  TLMN(K) = THIGH                                   MOD194
  TLMX(K) = TLOW                                    MOD194
  TTMX(K) = TLOW                                    MOD194
13  TTMN(K) = THIGH                                 MOD194
14  WRITE(*,*) TA,TB,TA,TB                          MODSD
  DO 8000 I=1,NZONES

```

$$\text{QHNMT}(I) = 0.0$$

These are all the changes made.

APPENDIX C

A SUMMARY OF THE MANUAL ITERATIONS PERFORMED TO TEST THE METHODOLOGY

TRIAL ONE WITH TFX.DAT AS

72
72
72
71
69
67
67
66
68
70
71
72

1 US ARMY CORPS OF ENGINEERS -- BLAST VERSION 3.0 (ANSI FORTRAN 77) LEVEL 215 12 APR 95 16:51: 8 PAGE 20

0	MONTH	GAS		STEAM		HOT WATER		COOLING COIL DEMAND (DX)	
		CONSUMPTION	PEAK DEMAND	CONSUMPTION	PEAK DEMAND	CONSUMPTION	PEAK DEMAND	CONSUMPTION	PEAK DEMAND
0		TOTAL USE		TOTAL USE		TOTAL USE		TOTAL USE	
		(BTU)	(BTU/HR)	(BTU)	(BTU/HR)	(BTU)	(BTU/HR)	(BTU)	(BTU/HR)
0	JAN	0.000E+00	0.000E+00	0.000E+00	0.000E+00	1.316E+07	4.118E+04	0.000E+00	0.000E+00
0	FEB	0.000E+00	0.000E+00	0.000E+00	0.000E+00	1.083E+07	3.854E+04	0.000E+00	0.000E+00
0	MAR	0.000E+00	0.000E+00	0.000E+00	0.000E+00	8.991E+06	3.647E+04	0.000E+00	0.000E+00
0	APR	0.000E+00	0.000E+00	0.000E+00	0.000E+00	2.695E+06	2.485E+04	7.154E+04	8.458E+03
0	MAY	0.000E+00	0.000E+00	0.000E+00	0.000E+00	0.000E+00	0.000E+00	2.936E+06	3.625E+04
0	JUN	0.000E+00	0.000E+00	0.000E+00	0.000E+00	0.000E+00	0.000E+00	7.201E+06	4.981E+04
0	JUL	0.000E+00	0.000E+00	0.000E+00	0.000E+00	0.000E+00	0.000E+00	9.446E+06	4.038E+04
0	AUG	0.000E+00	0.000E+00	0.000E+00	0.000E+00	0.000E+00	0.000E+00	1.086E+07	5.192E+04
0	SEP	0.000E+00	0.000E+00	0.000E+00	0.000E+00	1.619E+04	4.889E+03	3.962E+06	4.838E+04
0	OCT	0.000E+00	0.000E+00	0.000E+00	0.000E+00	4.475E+05	1.549E+04	4.791E+05	2.569E+04
0	NOV	0.000E+00	0.000E+00	0.000E+00	0.000E+00	5.766E+06	2.867E+04	0.000E+00	0.000E+00
0	DEC	0.000E+00	0.000E+00	0.000E+00	0.000E+00	1.415E+07	4.329E+04	0.000E+00	0.000E+00
0	TOT	0.000E+00	0.000E+00	0.000E+00	0.000E+00	5.606E+07	4.329E+04	3.495E+07	5.192E+04

1 US ARMY CORPS OF ENGINEERS -- BLAST VERSION 3.0 (ANSI FORTRAN 77) LEVEL 215 12 APR 95 16:51: 8 PAGE 21

WITH THESE LOADS, USING GLHEPRO WE GOT:

6 boreholes in a rectangle, B/H = 0.05

G-function file: C:\GLHEPRO\GFUNC\g0905.gfc

Active borehole length, H (ft) 150.0
 Borehole radius, RADb (in) 2.500
 Thermal conductivity, K (Btu/(hr*ft*F)) 2.02
 Volumetric heat capacity of ground, Cground (Btu/ft^3F) 32.21
 Volumetric heat capacity of fluid, Cfluid (Btu/ft^3F) 62.40
 Undisturbed ground temp., Tom (degrees F) 66.0

Borehole thermal resistance, Rb (F/Btu/ft*hr). 0.173
 Flow rate, Mdot (gal/min). 10.00
 Density of fluid, RHO (lb/ft^3). 62.400

Month	Monthly Loads Heating(Btu)	Cooling(Btu)
January	13160000.000	.000
February	10830000.000	.000
March	8991000.000	.000
April	2695000.000	71540.000
May	.000	2936000.000
June	.000	7201000.000
July	.000	9446000.000
August	.000	10860000.000
September	16190.000	3962000.000
October	447500.000	479100.000
November	5766000.000	.000
December	14150000.000	.000

Time (months)	Q (Btu/hr*ft)	Power (kW)	Tf (F)	Tin (F)	Tout (F)
1	19.65	.00	66.00	64.23	67.77
2	17.91	.00	54.48	52.87	56.09
3	13.43	.00	53.46	52.25	54.67
4	4.05	.00	54.96	54.60	55.32
5	-4.38	.00	60.07	60.47	59.68
6	-11.11	.00	65.61	66.61	64.61
7	-14.11	.00	70.72	71.99	69.45
8	-16.22	.00	73.90	75.36	72.44
9	-6.09	.00	76.42	76.96	75.87
10	-.05	.00	71.61	71.62	71.61
11	8.90	.00	67.87	67.07	68.67
12	21.13	.00	62.00	60.10	63.90

WITH THESE TEMPERATURES, GOING INTO BLAST, THE OUTPUT WAS:

TRIAL2:

0	0	GAS		STEAM		HOT WATER		COOLING COIL DEMAND (DX)	
		TOTAL USE		TOTAL USE		TOTAL USE		TOTAL USE	
	MONTH	CONSUMPTION (BTU)	PEAK DEMAND (BTU/HR)	CONSUMPTION (BTU)	PEAK DEMAND (BTU/HR)	CONSUMPTION (BTU)	PEAK DEMAND (BTU/HR)	CONSUMPTION (BTU)	PEAK DEMAND (BTU/HR)
0	JAN	0.000E+00	0.000E+00	0.000E+00	0.000E+00	1.307E+07	4.134E+04	0.000E+00	0.000E+00
0	FEB	0.000E+00	0.000E+00	0.000E+00	0.000E+00	1.056E+07	3.746E+04	4.758E+04	3.848E+04

0	MAR	0.000E+00	0.000E+00	0.000E+00	0.000E+00	8.706E+06	3.581E+04	0.000E+00	0.000E+00
0	APR	0.000E+00	0.000E+00	0.000E+00	0.000E+00	2.602E+06	2.426E+04	6.550E+04	8.675E+03
0	MAY	0.000E+00	0.000E+00	0.000E+00	0.000E+00	2.035E+04	1.513E+04	2.873E+06	3.581E+04
0	JUN	0.000E+00	0.000E+00	0.000E+00	0.000E+00	2.301E+04	1.711E+04	7.161E+06	4.998E+04
0	JUL	0.000E+00	0.000E+00	0.000E+00	0.000E+00	6.062E+03	5.939E+03	9.478E+06	4.080E+04
0	AUG	0.000E+00	0.000E+00	0.000E+00	0.000E+00	1.395E+04	1.038E+04	1.101E+07	5.248E+04
0	SEP	0.000E+00	0.000E+00	0.000E+00	0.000E+00	2.376E+04	9.872E+03	4.036E+06	4.933E+04
0	OCT	0.000E+00	0.000E+00	0.000E+00	0.000E+00	4.433E+05	1.576E+04	5.007E+05	2.626E+04
0	NOV	0.000E+00	0.000E+00	0.000E+00	0.000E+00	5.726E+06	2.880E+04	4.980E+03	4.885E+03
0	DEC	0.000E+00	0.000E+00	0.000E+00	0.000E+00	1.396E+07	4.286E+04	7.234E+03	7.047E+03
0		-----	-----	-----	-----	-----	-----	-----	-----
0	TOT	0.000E+00	0.000E+00	0.000E+00	0.000E+00	5.515E+07	4.286E+04	3.519E+07	5.248E+04

1 US ARMY CORPS OF ENGINEERS -- BLAST VERSION 3.0 (ANSI FORTRAN 77) LEVEL 215 12 APR 95 20:23:26 PAGE 21

TAKING THESE LOADS INTO GLHEPRO WE GOT

TRIAL2

6 boreholes in a rectangle, B/H = 0.05

G-function file: C:\GLHEPRO\GFUNC\g0905.gfc

Active borehole length, H (ft) 150.0
 Borehole radius, RADb (in) 2.500
 Thermal conductivity, K (Btu/(hr*ft*F)) 2.02
 Volumetric heat capacity of ground, Cground (Btu/ft^3F) 32.21
 Volumetric heat capacity of fluid, Cfluid (Btu/ft^3F) 62.40
 Undisturbed ground temp., Tom (degrees F) 66.0
 Borehole thermal resistance, Rb (F/Btu/ft*hr)173
 Flow rate, Mdot (gal/min) 10.00
 Density of fluid, RHO (lb/ft^3) 62.400

Month	Monthly Loads	
	Heating(Btu)	Cooling(Btu)
January	13070000.000	.000
February	10560000.000	47580.000
March	8706000.000	.000
April	2602000.000	65500.000
May	20350.000	2873000.000
June	23010.000	7161000.000
July	6062.000	9478000.000
August	13950.000	11010000.000
September	23760.000	4036000.000
October	443300.000	500700.000
November	5726000.000	4980.000
December	13960000.000	7234.000

Time (months)	Q (Btu/hr*ft)	Power (kW)	Tf (F)	Tin (F)	Tout (F)
1	19.52	.00	66.00	64.25	67.75
2	17.38	.00	54.56	52.99	56.12
3	13.00	.00	53.78	52.61	54.95
4	3.91	.00	55.27	54.92	55.62
5	-4.26	.00	60.24	60.62	59.85
6	-11.02	.00	65.61	66.60	64.62
7	-14.15	.00	70.70	71.97	69.43
8	-16.42	.00	73.95	75.43	72.47
9	-6.19	.00	76.56	77.12	76.01
10	-.09	.00	71.72	71.73	71.71
11	8.83	.00	67.94	67.14	68.73
12	20.84	.00	62.08	60.20	63.95

APPENDIX D.1

INPUT AND OUTPUT FILES OF THE INSULATED ONE ZONE BUILDING

```

#####          #####          #####
#####          #####          #####
#####          #####          #####
##### <#####>          #####          <#####>          #####          <#####>          #####
##### <#####>          #####          <#####>          #####          <###   ###>          #####
#####<#   ! ! ! ! #>          #####          <#   ! ! ! ! #>#####          <###   ###>          #####          #####
#####! ! ! ! ! #>          #####          <#   ! ! ! ! !#####          #####          #####          #####
##### ! ! ! ! ! #####>          #####          <### ! ! ! ! ! #####          <###>          #####          #####
#####-----#####          #####          <#####>          #####          <#####>          #####
#####          #<! ! ! ! ! ! ! !>#          #####          <#####>          #####          <#####>          #####
#####          #<! ! ! ! ! ! ! !>##          #####          #####          >###>          #####          #####
#####          ##<! ! ! ! ! ! ! !><##          #####          #####          #####          #####          #####
#####<#   #>          <!_!_!_!>          <#   #>#####          #####          #####          #####
##### <#####>          #####          <#####>          #####          <###   ###>          #####          <#####>
##### <#####>          #####          <#####>          #####          <#####>          #####          <#####>

```

TRADEMARK
APPLIED FOR

```

*****
*
*   A U.S. ARMY CORPS OF ENGINEERS PROGRAM
*
*           BY
*
*   CONSTRUCTION ENGINEERING RESEARCH LABORATORY
*   P.O. BOX 4005
*   CHAMPAIGN, ILLINOIS 61824-4005
*
*****

```

THIS PROGRAM IS FURNISHED BY THE GOVERNMENT AND IS ACCEPTED AND USED BY THE RECIPIENT WITH THE EXPRESS UNDERSTANDING THAT THE UNITED STATES GOVERNMENT MAKES NO WARRANTIES, EXPRESSED OR IMPLIED, CONCERNING THE ACCURACY, COMPLETENESS, RELIABILITY, USEABILITY, OR SUITABILITY FOR ANY PARTICULAR PURPOSE OF THE INFORMATION AND DATA CONTAINED IN THIS PROGRAM OR FURNISHED IN CONNECTION THEREWITH, AND THE UNITED STATES SHALL BE UNDER NO LIABILITY WHATSOEVER TO ANY PERSON BY REASON OF ANY USE MADE THEREOF. THE PROGRAM BELONGS TO THE GOVERNMENT. THEREFORE, THE RECIPIENT FURTHER AGREES NOT TO ASSERT ANY PROPRIETARY RIGHTS THEREIN OR TO REPRESENT THIS PROGRAM TO ANYONE AS OTHER THAN A GOVERNMENT PROGRAM.

```

0      2      RUN CONTROL:
0      3      NEW ZONES,
0      4      NEW AIR SYSTEMS,
0      5      PLANT,
0      6      REPORTS(WLHPS REPORT),
0      7      UNITS(IN=ENGLISH, OUT=ENGLISH);
0      8      TEMPORARY CONTROLS (DC):
0      9      PROFILES:
0     10      BEG=(1.0000 AT 68.00, 0.0000 AT 69.00, 0.0000 AT 72.00,
0     11      -1.0000 AT 73.00);
0     12      SCHEDULES:
0     13      MONDAY THRU FRIDAY=(0 TO 24-BEG),
0     14      SATURDAY=(0 TO 24-BEG),
0     15      SUNDAY=(0 TO 24-BEG),
0     16      HOLIDAY=(0 TO 24-BEG),
0     17      SPECIAL1=(0 TO 24-BEG),
0     18      SPECIAL2=(0 TO 24-BEG),
0     19      SPECIAL3=(0 TO 24-BEG),
0     20      SPECIAL4=(0 TO 24-BEG);
0     21      END;
0     22      PROJECT="VALIDATION OF MODEL ";
0     23      LOCATION=OKLAC ;
0     24      **      DESIGN DAYS=OKLAC SUMMER ,
0     25      **      OKLAC WINTER ;
0     26      WEATHER TAPE FROM 01JAN THRU 31DEC;
0     27      GROUND TEMPERATURES=(55, 55, 55, 55, 55, 55, 55, 55, 55, 55);
0     28      BEGIN BUILDING DESCRIPTION;
1 US ARMY CORPS OF ENGINEERS -- BLAST VERSION 3.0 (ANSI FORTRAN 77)      LEVEL 215      13 FEB 96      10:31:49      PAGE 2

```

```

0     29      BUILDING="VALIDATION OF MODEL ";
0     30      NORTH AXIS=0.00;
0     31      SOLAR DISTRIBUTION=-1;
0     32      ZONE 1 "ZONE1 " :
0     33      ORIGIN:(0.00, 0.00, 0.00);
0     34      NORTH AXIS=0.00;
0     35      PARTITIONS :
0     36      STARTING AT(0.00, 0.00, 0.00)
0     37      FACING(180.00)
0     38      TILTED(90.00)
0     39      INTERIOR (10.00 BY 8.00),
0     40      STARTING AT(10.00, 0.00, 0.00)
0     41      FACING(90.00)
0     42      TILTED(90.00)
0     43      INTERIOR (10.00 BY 8.00),
0     44      STARTING AT(10.00, 10.00, 0.00)
0     45      FACING(0.00)
0     46      TILTED(90.00)
0     47      INTERIOR (10.00 BY 8.00),
0     48      STARTING AT(0.00, 10.00, 0.00)
0     49      FACING(270.00)
0     50      TILTED(90.00)
0     51      INTERIOR (10.00 BY 8.00);
0     52      FLOORS :
0     53      STARTING AT(0.00, 10.00, 0.00)
0     54      FACING(180.00)
0     55      TILTED(180.00)
0     56      FLOOR (10.00 BY 10.00);
1 US ARMY CORPS OF ENGINEERS -- BLAST VERSION 3.0 (ANSI FORTRAN 77)      LEVEL 215      13 FEB 96      10:31:49      PAGE 3

```

```

0 57          CEILINGS :
0 58            STARTING AT(0.00, 0.00, 8.00)
0 59            FACING(180.00)
0 60            TILTED(0.00)
0 61            CEILING (10.00 BY 10.00);
0 62            OTHER=20.00,CONSTANT ,
0 63              0.00 PERCENT RADIANT, 0.00 PERCENT LATENT,
0 64              FROM 01JAN THRU 31DEC;
0 65            CONTROLS=DC ,
0 66              3412000.0 HEATING, 3412000.0 COOLING,
0 67              0.00 PERCENT MRT,
0 68              FROM 01JAN THRU 31DEC;
0 69            END ZONE;
0 70          END BUILDING DESCRIPTION;
0 71          BEGIN FAN SYSTEM DESCRIPTION;
0 72          WATER LOOP HEAT PUMP SYSTEM 1
0 73          "WATER LOOP " SERVING ZONES
0 74          1;
0 75          FOR ZONE 1:
0 76            SUPPLY AIR VOLUME=0.000001;
0 77            EXHAUST AIR VOLUME=0;
0 78            BASEBOARD HEAT CAPACITY=0.0;
0 79            BASEBOARD HEAT ENERGY SUPPLY=HOT WATER;
0 80            HEAT PUMP FLOW RATE=3500;
0 81            HEAT PUMP CAPACITY=37.5;
0 82            HEAT PUMP EER=14.0;
0 83            HEAT PUMP COP=4.4;
0 84            ZONE MULTIPLIER=1;
1 53 US ARMY CORPS OF ENGINEERS -- BLAST VERSION 3.0 (ANSI FORTRAN 77)
0 85          END ZONE;
0 86          OTHER SYSTEM PARAMETERS:
0 87            SUPPLY FAN PRESSURE=2.48914;
0 88            SUPPLY FAN EFFICIENCY=0.7;
0 89            RETURN FAN PRESSURE=0.0;
0 90            RETURN FAN EFFICIENCY=0.7;
0 91            EXHAUST FAN PRESSURE=1.00396;
0 92            EXHAUST FAN EFFICIENCY=0.7;
0 93            HEATING COIL ENERGY SUPPLY=HOT WATER;
0 94            HEATING COIL CAPACITY=3412000;
0 95            MIXED AIR CONTROL=FIXED AMOUNT;
0 96            DESIRED MIXED AIR TEMPERATURE=COLD DECK TEMPERATURE;
0 97            OUTSIDE AIR VOLUME=0.0000000;
0 98            GAS BURNER EFFICIENCY=0.8;
0 99            SYSTEM ELECTRICAL DEMAND=0.0;
0 100           LOOP MASS RATIO=0.5;
0 101           SYSTEM PRESSURE HEAD=401.474213311;
0 102           LOOP PUMP EFFICIENCY=0.85;
0 103           TANK TEMPERATURE=75.65;
0 104           FIXED LOOP TEMPERATURE=75.65;
0 105           MAXIMUM LOOP TEMPERATURE=100.0;
0 106           MINIMUM LOOP TEMPERATURE=45.0;
0 107           STORAGE VOLUME=0.0;
0 108           SUPPLEMENTAL HEAT TYPE=HOT WATER;
0 109           SUPPLEMENTAL COOL TYPE=COMPRESSION;
0 110           NOMINAL FLOW RATE=93.4;
0 111           NOMINAL PRESSURE DROP=0.004014742;

```

LEVEL 215 13 FEB 96 10:31:49 PAGE 4

```

0      112          LOOP MASS=500;
1 US ARMY CORPS OF ENGINEERS -- BLAST VERSION 3.0 (ANSI FORTRAN 77)    LEVEL 215    13 FEB 96    10:31:49    PAGE 5

0      113          LOOP CONTROL=FIXED TEMPERATURE;
0      114          COOLING TOWER CAPACITY=3414425.0;
0      115          TOWER ELECTRIC COEFFICIENT=0.241;
0      116          TOWER PUMP COEFFICIENT=0.013;
0      117          PUMP TYPE=CONSTANT FLOW;
0      118          END OTHER SYSTEM PARAMETERS;
0      119          COOLING COIL DESIGN PARAMETERS:
0      120          COIL TYPE=CHILLED WATER;
0      121          END COOLING COIL DESIGN PARAMETERS;
0      122          WATER SOURCE HEAT PUMP PARAMETERS:
0      123          HHCP(-5.110967,5.927661,0.0);
0      124          HCCP(3.87711728,-2.5862718,0.0);
0      125          HCOP(-1.316744,2.322787,0.0);
0      126          HEER(11.747092,-10.1302,0.0);
0      127          PRSURE(0.0,0.0,0.0);
0      128          WLPT(0.0,1.0,0.0);
0      129          END WATER SOURCE HEAT PUMP PARAMETERS;
0      130          EQUIPMENT SCHEDULES:
0      131          SYSTEM OPERATION=ON, FROM 01JAN THRU 31DEC;
0      132          EXHAUST FAN OPERATION=OFF, FROM 01JAN THRU 31DEC;
0      133          HEATING COIL OPERATION=OFF, FROM 01JAN THRU 31DEC;
0      134          COOLING COIL OPERATION=OFF, FROM 01JAN THRU 31DEC;
0      135          TSTAT BASEBOARD HEAT OPERATION=OFF, FROM 01JAN THRU 31DEC;
0      136          HEAT RECOVERY OPERATION=OFF, FROM 01JAN THRU 31DEC;
0      137          MINIMUM VENTILATION SCHEDULE=MINOA, FROM 01JAN THRU 31DEC;
0      138          MAXIMUM VENTILATION SCHEDULE=MAXOA, FROM 01JAN THRU 31DEC;
0      139          SYSTEM ELECTRICAL DEMAND SCHEDULE=ON, FROM 01JAN THRU 31DEC;
0      140          WLHPS STORAGE TANK OPERATION=OFF, FROM 01JAN THRU 31DEC;
1 US ARMY CORPS OF ENGINEERS -- BLAST VERSION 3.0 (ANSI FORTRAN 77)    LEVEL 215    13 FEB 96    10:31:49    PAGE 6

0      141          WLHPS VENTILATION SYSTEM OPERATION=OFF, FROM 01JAN THRU 31DEC;
0      142          WLHPS LOOP CONTROL SCHEDULE=OFF, FROM 01JAN THRU 31DEC;
0      143          END EQUIPMENT SCHEDULES;
0      144          END SYSTEM;
0      145          END FAN SYSTEM DESCRIPTION;
0      146          END INPUT;
1 US ARMY CORPS OF ENGINEERS -- BLAST VERSION 3.0 (ANSI FORTRAN 77)    LEVEL 215    13 FEB 96    10:31:49    PAGE 7

0      REPORTING WILL BE DONE IN UNITS ENGLISH
0      SIMULATIONS WILL BE ALLOWED FOR TYPES% ZONES      SYSTEMS      PLANTS

          1 BUILDING SIMULATIONS WILL BE ATTEMPTED

          SIMULATIONS WILL BE ATTEMPTED FOR    1 ZONES

          SIMULATIONS WILL BE ATTEMPTED FOR    1 SYSTEMS

          SIMULATIONS WILL BE ATTEMPTED FOR    0 PLANTS
0 NEW BLDLFL AND AHLDFL FILES WILL BE CREATED
  FROM USER INPUT, AS NECESSARY
0      LOCATION TAKEN FROM ATTACHED WTHRFL
  TITLE=  OKLAHOMA CITY/WILL RODGERS, OK      LAT=  35.400 LONG=  97.600 TIME ZONE= 6.0
0 * * * * *
  BLDLFL FOR
  VALIDATION OF MODEL

```

LOCATION OKLAHOMA CITY/WILL RODGERS, OK LAT= 35.400 LONG= 97.600 TIME ZONE= 6.0
 DATE OF FILE CREATE/UPDATE 13 FEB 96 NUMBER OF ENVIRONMENTS 1
 NUMBER OF ZONES 1 WITH ZONE NUMBERS

1
 * * * * *

AHLDFL FOR
 VALIDATION OF MODEL

LOCATION OKLAHOMA CITY/WILL RODGERS, OK LAT= 35.400 LONG= 97.600 TIME ZONE= 6.0
 DATE OF FILE CREATE/UPDATE 13 FEB 96 NUMBER OF ENVIRONMENTS 1
 NUMBER OF SYSTEMS 1 WITH SYSTEM NUMBERS
 1

***** SIMULATION PERIOD 1 JAN 1979 THRU 31 DEC 1979

0 ENVIRONMENT NUMBER 1 FOR BLDFL TITLE IS OKLAHOMA CITY/WILL RODGERS, OK
 WEATHER STATION 13967 START DATE OF 1 JAN 1979 NO. OF DAYS 365
 WITH GROUND TEMPERATURES JAN =55.00 FEB =55.00 MAR =55.00 APR =55.00 MAY =55.00 JUN =55.00
 JUL =55.00 AUG =55.00 SEP =55.00 OCT =55.00 NOV =55.00 DEC =55.00
 WITH MAKE UP WATER TEMPERATURES JAN =55.00 FEB =55.00 MAR =55.00 APR =55.00 MAY =55.00 JUN =55.00
 JUL =55.00 AUG =55.00 SEP =55.00 OCT =55.00 NOV =55.00 DEC =55.00

0 ENVIRONMENT NUMBER 1 FOR AHLDFL TITLE IS OKLAHOMA CITY/WILL RODGERS, OK
 WEATHER STATION 13967 START DATE OF 1 JAN 1979 NO. OF DAYS 365
 WITH GROUND TEMPERATURES JAN =55.00 FEB =55.00 MAR =55.00 APR =55.00 MAY =55.00 JUN =55.00
 JUL =55.00 AUG =55.00 SEP =55.00 OCT =55.00 NOV =55.00 DEC =55.00
 WITH MAKE UP WATER TEMPERATURES JAN =55.00 FEB =55.00 MAR =55.00 APR =55.00 MAY =55.00 JUN =55.00
 JUL =55.00 AUG =55.00 SEP =55.00 OCT =55.00 NOV =55.00 DEC =55.00

1 US ARMY CORPS OF ENGINEERS -- BLAST VERSION 3.0 (ANSI FORTRAN 77) LEVEL 215 13 FEB 96 10:31:49 PAGE 8

ZONE GROUP LOADS FOR OKLAHOMA CITY/WILL RODGERS, OK

SIMULATION PERIOD 1 JAN 1979 THRU 31 DEC 1979

NUMBER	NAME		MULTIPLIER					
1	1	ZONE1	1					
ZONE	TOTAL CONVECTIVE HEATER LOAD	TOTAL RADIANT HEATER LOAD	TOTAL SENSIBLE COOLING LOAD	PEAK CONVECTIVE HEATER LOAD	PEAK RADIANT HEATER LOAD	PEAK SENSIBLE COOLING LOAD	MAX TEMP	MIN TEMP
	1000BTU	1000BTU	1000BTU	1000BTU/HR	1000BTU/HR	1000BTU/HR	DEG. F	DEG. F
1	0.000E+00	0.000E+00	1.752E+05	0.000E+00	0.000E+00	2.000E+01	72.00	72.00
OGROUP:	0.000E+00	0.000E+00	1.752E+05	0.000E+00	0.000E+00	2.000E+01	72.00	72.00
OPEAK DATES (MO/DY/HR):				1/ 1/ 1	1/ 1/ 1	1/ 1/ 1	1/ 1/ 1	12/31/24
OTOTAL ITERATIONS =	8810							
DID NOT CONVERGE =	0							

1 US ARMY CORPS OF ENGINEERS -- BLAST VERSION 3.0 (ANSI FORTRAN 77) LEVEL 215 13 FEB 96 10:31:49 PAGE 9

**
 ** AIR HANDLING SYSTEM DESCRIPTION **
 **

SYSTEM NUMBER= 1, WATER LOOP
 0 TYPE SYS = WATER LOOP HEAT PUMP NO. DISTINCT ZONES ON SYS. = 1

TOTAL SUPPLY FAN PRESSURE = 2.48914 IN-H2O
 TOTAL RETURN FAN PRESSURE = 0.00000 IN-H2O
 TOTAL EXHAUST FAN PRESSURE = 1.00396 IN-H2O

SUPPLY FAN EFFICIENCY = 0.70
 RETURN FAN EFFICIENCY = 0.70
 EXHAUST FAN EFFICIENCY = 0.70
 0 MIXED AIR CONTROL = FIXED AMOUNT
 FIXED OUTSIDE AIR VOLUME = 0.000E+00 FT**3/MIN
 DESIRED MIXED AIR TEMPERATURE = COLD DECK TEMP
 0 HOT DECK CONTROL = FIXED SET POINT
 HOT DECK THROTTLING RANGE = 7.20000 DEG. F
 HOT DECK FIXED TEMPERATURE = 140.00000 DEG. F
 0 HEATING COIL CAPACITY = 0.341E+07 1000BTU/HR
 HEATING COIL ENERGY SUPPLY = HOT WATER
 0 COLD DECK CONTROL = FIXED SET POINT
 COLD DECK THROTTLING RANGE = 7.20000 DEG. F
 COLD DECK FIXED TEMPERATURE = 55.04000 DEG. F

0 ZONE DATA SUMMARY
 0 ZONE ZONE ZONE ZONE ZONE ZONE ZONE ZONE
 NUMBER SUPPLY EXHAUST REHEAT REHEAT TSTAT BB TSTAT BB MULT
 AIR VOL AIR VOL CAPCTY ENERGY CAPCTY ENERGY
 0 1 1.000E-06 0.000E+00 0.000E+00 HOT WATER 0.000E+00 HOT WATER 1.0
 0 TOTAL DESIGN SUPPLY AIR VOLUME = 1.000E-06

1 US ARMY CORPS OF ENGINEERS -- BLAST VERSION 3.0 (ANSI FORTRAN 77) LEVEL 215 13 FEB 96 10:31:49 PAGE 10

 **
 ** W L H P S SYSTEM ENERGY USAGE REPORT **
 **

SYSTEM NUMBER= 1, WATER LOOP
 SYSTEM LOCATION = 13967 OKLAHOMA CITY/WILL RODGERS, OK SIMULATION PERIOD 1JAN1979 - 31DEC1979
 W L H P S ENERGY DEMANDS

MONTH	HEAT PUMPS		LOOP PUMP		HEAT LOAD		COOL LOAD		LOOP TEMP		TANK TEMP	
	CONSUMPTION/PEAK 1000BTU	1000BTU/H	CONSUMPTION/PEAK 1000BTU	1000BTU/H	CONSUMPTION/PEAK 1000BTU	1000BTU/H	CONSUMPTION/PEAK 1000BTU	1000BTU/H	MAX	MIN	MAX	MIN
JAN	4.59E+03	6.17E+00	1.32E+02	1.77E-01	0.00E+00	0.00E+00	1.93E+04	2.59E+01	90.974	78.507	75.650	75.650
FEB	4.15E+03	6.17E+00	1.19E+02	1.77E-01	0.00E+00	0.00E+00	1.74E+04	2.59E+01	90.995	90.978	75.650	75.650
MAR	4.59E+03	6.17E+00	1.32E+02	1.77E-01	0.00E+00	0.00E+00	1.93E+04	2.59E+01	91.025	91.001	75.650	75.650
APR	4.45E+03	6.18E+00	1.28E+02	1.77E-01	0.00E+00	0.00E+00	1.86E+04	2.59E+01	91.054	91.030	75.650	75.650
MAY	4.60E+03	6.18E+00	1.32E+02	1.77E-01	0.00E+00	0.00E+00	1.93E+04	2.59E+01	91.084	91.060	75.650	75.650
JUN	4.45E+03	6.19E+00	1.28E+02	1.77E-01	0.00E+00	0.00E+00	1.86E+04	2.59E+01	91.113	91.089	75.650	75.650

JUL	4.60E+03	6.19E+00	1.32E+02	1.77E-01	0.00E+00	0.00E+00	1.93E+04	2.59E+01	91.142	91.118	75.650	75.650
AUG	4.61E+03	6.19E+00	1.32E+02	1.77E-01	0.00E+00	0.00E+00	1.93E+04	2.59E+01	91.163	91.145	75.650	75.650
SEP	4.46E+03	6.19E+00	1.28E+02	1.77E-01	0.00E+00	0.00E+00	1.86E+04	2.59E+01	91.184	91.167	75.650	75.650
OCT	4.61E+03	6.20E+00	1.32E+02	1.77E-01	0.00E+00	0.00E+00	1.93E+04	2.59E+01	91.204	91.187	75.650	75.650
NOV	4.46E+03	6.20E+00	1.28E+02	1.77E-01	0.00E+00	0.00E+00	1.86E+04	2.59E+01	91.225	91.208	75.650	75.650
DEC	4.61E+03	6.20E+00	1.32E+02	1.77E-01	0.00E+00	0.00E+00	1.93E+04	2.59E+01	91.245	91.228	75.650	75.650

TOT 5.42E+04 6.20E+00 1.55E+03 1.77E-01 0.00E+00 0.00E+00 2.27E+05 2.59E+01

1 US ARMY CORPS OF ENGINEERS -- BLAST VERSION 3.0 (ANSI FORTRAN 77) LEVEL 215 13 FEB 96 10:31:49 PAGE 11

 **
 ** HEAT PUMP NETWORK SUMMARY **
 **

SYSTEM NUMBER= 1, WATER LOOP
 SYSTEM LOCATION = 13967 OKLAHOMA CITY/WILL RODGERS, OK SIMULATION PERIOD 1JAN1979 - 31DEC1979

MONTH	ZONE 1										OUTLET TEMP.	
	PUMP1		PUMP2		PUMP3		PUMP4		PUMP5		MAX	MIN
	CONSUMPTION	1000BTU/H	CONSUMPTION	1000BTU/H	CONSUMPTION	1000BTU/H	CONSUMPTION	1000BTU/H	CONSUMPTION	1000BTU/H		
JAN	4.59E+03	6.17E+00	0.00E+00	0.00E+00	0.00E+00	0.00E+00	0.00E+00	0.00E+00	0.00E+00	0.00E+00	105.44	78.05
FEB	4.15E+03	6.17E+00	0.00E+00	0.00E+00	0.00E+00	0.00E+00	0.00E+00	0.00E+00	0.00E+00	0.00E+00	105.46	91.04
MAR	4.59E+03	6.17E+00	0.00E+00	0.00E+00	0.00E+00	0.00E+00	0.00E+00	0.00E+00	0.00E+00	0.00E+00	105.49	91.07
APR	4.45E+03	6.18E+00	0.00E+00	0.00E+00	0.00E+00	0.00E+00	0.00E+00	0.00E+00	0.00E+00	0.00E+00	105.52	91.10
MAY	4.60E+03	6.18E+00	0.00E+00	0.00E+00	0.00E+00	0.00E+00	0.00E+00	0.00E+00	0.00E+00	0.00E+00	105.55	91.13
JUN	4.45E+03	6.19E+00	0.00E+00	0.00E+00	0.00E+00	0.00E+00	0.00E+00	0.00E+00	0.00E+00	0.00E+00	105.58	91.16
JUL	4.60E+03	6.19E+00	0.00E+00	0.00E+00	0.00E+00	0.00E+00	0.00E+00	0.00E+00	0.00E+00	0.00E+00	105.61	91.19
AUG	4.61E+03	6.19E+00	0.00E+00	0.00E+00	0.00E+00	0.00E+00	0.00E+00	0.00E+00	0.00E+00	0.00E+00	105.63	91.21
SEP	4.46E+03	6.19E+00	0.00E+00	0.00E+00	0.00E+00	0.00E+00	0.00E+00	0.00E+00	0.00E+00	0.00E+00	105.65	91.23
OCT	4.61E+03	6.20E+00	0.00E+00	0.00E+00	0.00E+00	0.00E+00	0.00E+00	0.00E+00	0.00E+00	0.00E+00	105.67	91.25
NOV	4.46E+03	6.20E+00	0.00E+00	0.00E+00	0.00E+00	0.00E+00	0.00E+00	0.00E+00	0.00E+00	0.00E+00	105.69	91.27
DEC	4.61E+03	6.20E+00	0.00E+00	0.00E+00	0.00E+00	0.00E+00	0.00E+00	0.00E+00	0.00E+00	0.00E+00	105.71	91.29
TOT	5.42E+04	6.20E+00	0.00E+00	0.00E+00	0.00E+00	0.00E+00	0.00E+00	0.00E+00	0.00E+00	0.00E+00		

1 US ARMY CORPS OF ENGINEERS -- BLAST VERSION 3.0 (ANSI FORTRAN 77) LEVEL 215 13 FEB 96 10:31:49 PAGE 12

 **
 ** W L H P S SYSTEM LOADS REPORT **
 **

SYSTEM NUMBER= 1, WATER LOOP
 SYSTEM LOCATION = 13967 OKLAHOMA CITY/WILL RODGERS, OK SIMULATION PERIOD 1JAN1979 - 31DEC1979

 *** SURFACE CONSTRUCTIONS ***

U
 WITHOUT FILM COEFF
 (B/H**2**R)

INTERIOR	0.495	
C7 - 8 IN LW CONCRETE BLOCK		0.495
FLOOR	0.321	
E5 - ACOUSTIC TILE		0.560
E4 - CEILING AIRSPACE		1.000
C5 - 4 IN HW CONCRETE		3.003
CEILING	0.321	
C5 - 4 IN HW CONCRETE		3.003
E4 - CEILING AIRSPACE		1.000
E5 - ACOUSTIC TILE		0.560

1 US ARMY CORPS OF ENGINEERS -- BLAST VERSION 3.0 (ANSI FORTRAN 77) LEVEL 215 13 FEB 96 10:31:49 PAGE 17

 *** FAN SYSTEM DATA ***

SYSTEM 1 WATER LOOP HEAT PUMP WATER LOOP

SERVING ZONES: 1

MIXED AIR CONTROL = FIXED AMOUNT
 FIXED OUTSIDE AIR VOLUME = 0 FT**3/MIN
 COLD DECK CONTROL = FIXED SET POINT
 HOT DECK CONTROL = FIXED SET POINT

DESIRED MIXED AIR TEMP = COLD DECK TEMP
 COLD DECK FIXED TEMP = 55 DEG. F
 HOT DECK FIXED TEMP = 140 DEG. F

SYSTEM OPERATION = ON, 1JAN THRU 31DEC
 PREHEAT COIL OPERATION =ON,01JAN THRU 31DEC
 COOLING COIL OPERATION = OFF, 1JAN THRU 31DEC
 TSTAT BASEBOARD HEAT OPERATION = OFF, 1JAN THRU 31DEC
 MINIMUM VENTILATION SCHEDULE = MINIMUM OUTSIDE AIR, 1JAN THRU 31DEC
 MAXIMUM VENTILATION SCHEDULE = ON, 1JAN THRU 31DEC
 SYSTEM ELECTRICAL DEMAND SCHEDULE = ON, 1JAN THRU 31DEC
 EVAPORATIVE COOLER OPERATION =ON,01JAN THRU 31DEC
 HEAT PUMP COOLING OPERATION =ON,01JAN THRU 31DEC
 WLHPS STORAGE TANK OPERATION = OFF, 1JAN THRU 31DEC
 WLHPS VENTILATION SYSTEM OPERATIO = OFF, 1JAN THRU 31DEC
 WLHPS LOOP CONTROL SCHEDULE = OFF, 1JAN THRU 31DEC
 VAV MINIMUM AIR FRACTION SCHEDULE =ON,01JAN THRU 31DEC

EXHAUST FAN OPERATION = OFF, 1JAN THRU 31DEC
 HEATING COIL OPERATION = OFF, 1JAN THRU 31DEC
 HUMIDIFIER OPERATION =ON,01JAN THRU 31DEC
 HEAT RECOVERY OPERATION = OFF, 1JAN THRU 31DEC
 HEAT PUMP BACKUP HEAT OPERATION =ON,01JAN THRU 31DEC
 HEAT PUMP HEATING OPERATION =ON,01JAN THRU 31DEC

ZONE	SUPPLY AIR VOLUME FT**3/MIN	MINIMUM AIR FRACTION	EXHAUST AIR VOLUME FT**3/MIN	REHEAT CAPACITY	BASEBOARD HEAT CAPACITY	RECOOL CAPACITY	ZONE MULTIPLIER
1	1.000E-06	0.00	0.000E+00	0.000E+00	0.000E+00	0.000E+00	1

***** NO PLANTS WERE SIMULATED *****

1 US ARMY CORPS OF ENGINEERS -- BLAST VERSION 3.0 (ANSI FORTRAN 77) LEVEL 215 13 FEB 96 10:31:49 PAGE 18

 *** SCHEDULED LOADS ***

ZONE NUMBER	FROM	THRU	SCHEDULE	DESIGN PEAK LOAD	DESIGN PEAK LOAD PER FT**2	# HOURS PER WEEK	AVERAGE LOAD WHEN LOAD SCHEDULED
1	US ARMY CORPS OF ENGINEERS	--	BLAST VERSION 3.0 (ANSI FORTRAN 77)	LEVEL 215	13 FEB 96	10:31:49	PAGE 19

 *** SCHEDULED LOADS ***

ZONE NUMBER	FROM	THRU	SCHEDULE	DESIGN PEAK LOAD	DESIGN PEAK LOAD PER FT**2	# HOURS PER WEEK	AVERAGE LOAD WHEN LOAD SCHEDULED
-------------	------	------	----------	------------------	----------------------------	------------------	----------------------------------

NO PEOPLE:
 NO LIGHTS:
 NO ELECT EQUIP:
 NO GAS EQUIP:

OTHER EQUIP LOADS:

NEGATIVE AMOUNTS DENOTE LOSS, POSITIVE AMOUNTS DENOTE GAIN
 OTHER EQUIPMENT LOADS ARE NOT INCLUDED IN ENERGY BUDGET FIGURES.

1	1JAN 31DEC	CONSTANT	20.0	1000BTU	2.000E-01	168.	2.000E+01	1000BTU
---	------------	----------	------	---------	-----------	------	-----------	---------

 *** INFILTRATION AND VENTILATION ***

NUMBER	FROM	THRU	OCCUPIED MAX	OCCUPIED MIN	UNOCCUPIED MAX	UNOCCUPIED MIN	SPECIFIED PEAK FLOW
--------	------	------	--------------	--------------	----------------	----------------	---------------------

NO INFILTRATION:
 NO NATURAL VENTILATION:

1 US ARMY CORPS OF ENGINEERS -- BLAST VERSION 3.0 (ANSI FORTRAN 77) LEVEL 215 13 FEB 96 10:31:49 PAGE 20

 *** MECHANICAL VENTILATION ***

NUMBER	FROM	THRU	OCCUPIED		UNOCCUPIED		PEAK FLOW	
			MAX	MIN	MAX	MIN		
OUTSIDE AIR:								
SYS 1	1JAN	THRU 31DEC, ON	FT**3/MIN	*****	*****	0.0E+00	0.0E+00	0.0E+00
			MO/DA/HR	*****	*****	1/ 1/ 1	1/ 1/ 1	

 *** SPACE TEMPERATURES DEG. F ***

ZONE NUMBER	CONTROLS	HEATING				COOLING				NO HEATING OR COOLING			
		OCCUPIED		UNOCCUPIED		OCCUPIED		UNOCCUPIED		OCCUPIED		UNOCCUPIED	
		MAX	MIN	MAX	MIN	MAX	MIN	MAX	MIN	MAX	MIN	MAX	MIN
1	DC	*****	*****	*****	*****	*****	*****	72.00	72.00	*****	*****	*****	*****
1	US ARMY CORPS OF ENGINEERS -- BLAST VERSION 3.0 (ANSI FORTRAN 77)	LEVEL 215				13 FEB 96		10:31:49		PAGE 21			

 *** ZONES ENERGY BUDGET ***

CATEGORY CODE = 00000	SIMULATION PERIOD = 1 JAN 1979 - 31 DEC 1979
FACILITY CATEGORY = UNKNOWN BUILDING CATEGORY	BUDGET REGION = 4
LOCATION = OKLAHOMA CITY/WILL RODGERS, OK	HEATING DEGREE DAYS = 3869.0
PROJECT TITLE = VALIDATION OF MODEL	COOLING DEGREE DAYS = 1820.9
	REQUIRED ENERGY BUDGET= ???

ZONE LOAD

NUMBER	TOTAL HEAT 1000BTU	TOTAL COOL 1000BTU	TOTAL ELECT 1000BTU	TOTAL GAS 1000BTU	INFIL LOSS 1000BTU	INFIL GAIN 1000BTU	TOTAL AREA FT**2	ENERGY BUDGET 1000BTU / FT**2
1	0.000E+00	1.752E+05	0.000E+00	0.000E+00	0.000E+00	0.000E+00	1.000E+02	1.752E+03
TOTAL	0.000E+00	1.752E+05	0.000E+00	0.000E+00	0.000E+00	0.000E+00	1.000E+02	

ENERGY BUDGET FOR ALL ZONES = 1.752E+03 1000BTU / FT**2

*** ZONE ENERGY BUDGETS DO NOT INCLUDE FAN SYSTEMS OR EQUIPMENT INEFFICIENCIES
 1 US ARMY CORPS OF ENGINEERS -- BLAST VERSION 3.0 (ANSI FORTRAN 77) LEVEL 215 13 FEB 96 10:31:49 PAGE 22

 *** SYSTEMS ENERGY BUDGET ***

CATEGORY CODE = 00000
 FACILITY CATEGORY = UNKNOWN BUILDING CATEGORY
 LOCATION = OKLAHOMA CITY/WILL RODGERS, OK
 PROJECT TITLE = VALIDATION OF MODEL

SIMULATION PERIOD = 1 JAN 1979 - 31 DEC 1979
 BUDGET REGION = 4
 HEATING DEGREE DAYS = 3869.0
 COOLING DEGREE DAYS = 1820.9
 REQUIRED ENERGY BUDGET= ???

SYSTEM LOADS

NUMBER	UNDER HEAT 1000BTU	HOURS	UNDER COOL 1000BTU	HOURS	OVER HEAT 1000BTU	HOURS	OVER COOL 1000BTU	HOURS	HEAT W/O DMD 1000BTU	HOURS	COOL W/O DMD 1000BTU	HOURS
1	0.000E+00	(0)	0.000E+00	(0)	0.000E+00	(0)	0.000E+00	(0)	0.000E+00	(0)	0.000E+00	(0)
TOTAL	0.000E+00	(0)	0.000E+00	(0)	0.000E+00	(0)	0.000E+00	(0)	0.000E+00	(0)	0.000E+00	(0)

NUMBER	TOTAL HEAT 1000BTU	TOTAL COOL 1000BTU	TOTAL ELECT 1000BTU	TOTAL GAS 1000BTU	TOTAL AREA FT**2	ENERGY BUDGET 1000BTU / FT**2
1	0.000E+00	2.268E+05	5.574E+04	0.000E+00	1.000E+02	2.825E+03
TOTAL	0.000E+00	2.268E+05	5.574E+04	0.000E+00	1.000E+02	

ENERGY BUDGET FOR ALL SYSTEMS = 2.825E+03 1000BTU / FT**2

*** ENERGY BUDGET DOES NOT INCLUDE UNDER/OVER/W.O. DEMAND HEATING/COOLING ITEMS

***** NO PLANT INFORMATION AVAILABLE *****

1 US ARMY CORPS OF ENGINEERS -- BLAST VERSION 3.0 (ANSI FORTRAN 77) LEVEL 215 13 FEB 96 10:31:49 PAGE 23

PSYCHROMETRIC ERROR SUMMARY
 0 CUMULATIVE FOR ENTIRE RUN

ROUTINE	NUMBER OF ERRORS
PSYDPT	0
PSYRHT	0
PSYTW	0
PSYVTD	0
PSYVTP	0
PSYWDP	0
PSYWTH	0
PSYWTP	0
PSYWTR	0

SATUPT	0
SATUTH	0
SATUTP	0

APPENDIX D.2

CALCULATING BLAST HEAT PUMP PERFORMANCE COEFFICIENTS

Specifications on heat pump SX036 form the Florida Heat Pumps Catalog
63 WB, 70 DB, 7GPM

Fluid Temp / TREF	Cooling (KBtu/hr)	Heating (KBtu/hr)	EER	COP	Fluid Tem (R)
0.987612524	49.4	30.6	24.9	4.3	504.67
0.99739726	48.9	32.7	23.1	4.4	509.67
1.016966732	47.1	37.6	19.9	4.6	519.67
1.038536204	45.2	42.4	17.2	4.8	529.67
1.065890411	42		12.5		544.67
1.095244618	39.2		9.9		559.67

Slope: INDEX(LINEST(known_y's,known_x's),1) Y-intercept: INDEX(LINEST(known_y's,known_x's),2)

M cooling	C cooling	M EER	C EER
-97.24382028	145.77961	-141.82344	164.4593
M Heating	C Heating	M COP	C COP
243.034108	-209.5492531	10.220264	-5.79367

Base Values were chosen using manufacturer base values.

Cooling Cap Base = 37.6 Heating cap base = 41.0
EER base = 14.0 COP base = 4.4

Therefore the relative values for the coefficients are:

A1	B1	D1	E1
3.877117288	-2.586271816	11.7470919	-10.1302
A2	B2	D2	E2
-5.110957392	5.927661171	-1.316744	2.322787

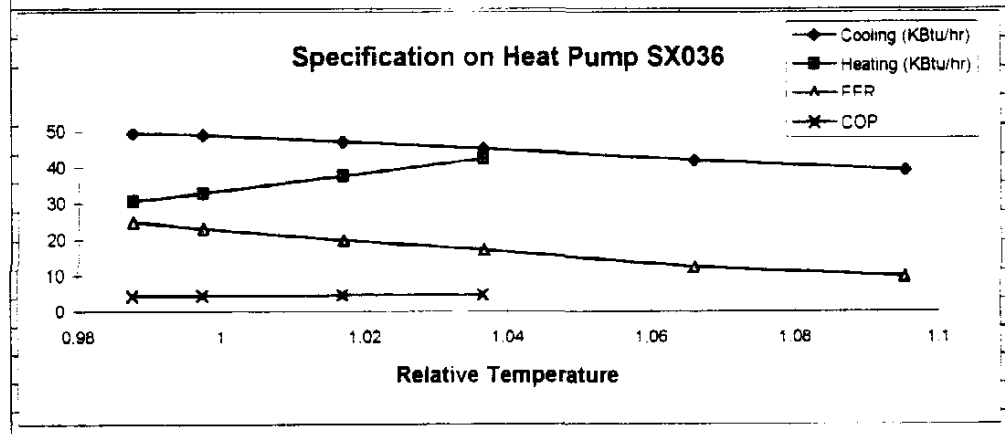

APPENDIX D.3

COMPARING BLAST AND GLHEPRO WATER LOOP AND HEAT PUMP MODELS

Results from the GLHEPRO model of the Heat pump.

Month	Cooling load on H.P (Btu)	Rej. Q to ground (Btu/hr ² ft)	Q (Btu)	Difference bet. H.P load and the Rej. Q (Btu)
1	14900000	38.93	17378352	2478352
2	13400000	40.93	16502976	3102976
3	14900000	41.44	18498816	3598816
4	14400000	41.58	17962560	3562560
5	14900000	41.76	18641664	3741664
6	14400000	41.8	18057600	3657600
7	14900000	41.93	18717552	3817552
8	14900000	42	18748800	3848800
9	14400000	42.01	18148320	3748320
10	14900000	42.14	18811296	3911296
11	14400000	42.15	18208800	3808800
12	14900000	42.27	18869328	3969328

Results from the BLAST model of the Heat Pump.

Month	Cooling load on H.P (Btu)	Rej. Q to ground (Btu/hr ² ft)	Q (Btu)	Difference bet. H.P load and the Rej. Q (Btu)
1	14900000	38.41	17146224	2246224
2	13400000	40.18	16200576	2800576
3	14900000	40.15	17922960	3022960
4	14400000	41.59	17966880	3566880
5	14900000	41.56	18552384	3652384
6	14400000	41.55	17949600	3549600
7	14900000	41.54	18543456	3643456
8	14900000	41.53	18538992	3638992
9	14400000	41.53	17940960	3540960
10	14900000	41.52	18534528	3634528
11	14400000	41.52	17936640	3536640
12	14900000	41.52	18534528	3634528

Studying the difference between the two models.

Difference between		The difference as a	
the models (Btu)		percentage of load	
Month		Month	on heat pump
1	232128	1	1.55790604
2	302400	2	2.256716418
3	575856	3	3.864805369
4	-4320	4	-0.03
5	89280	5	0.599194631
6	108000	6	0.75
7	174096	7	1.16842953
8	209808	8	1.408107383
9	207360	9	1.44
10	276768	10	1.857503356
11	272160	11	1.89
12	334800	12	2.246979866
		Average	1.584136883

The difference as a percentage of load on heat pump

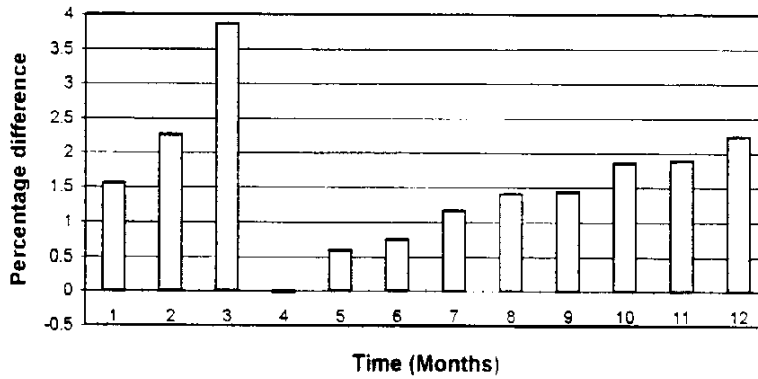

APPENDIX E.1

COPY OF ONE OF THE DAYCARE CENTER BLUE PRINT

FLOOR PLAN
K&B 1/24/50

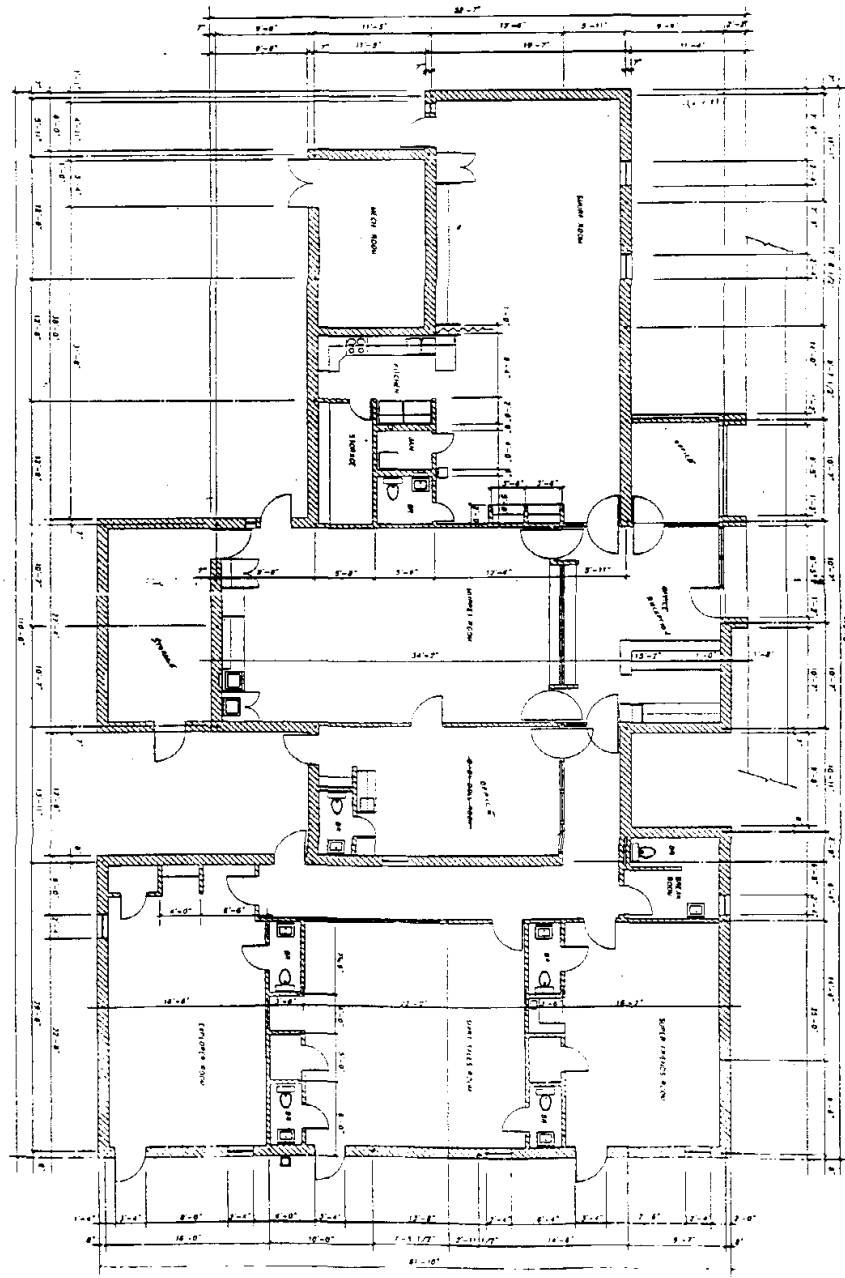

APPENDIX E.2

BLAST INPUT FILE FOR THE DAYCARE CENTER

```

BEGIN INPUT;
RUN CONTROL:
NEW ZONES,
NEW AIR SYSTEMS,
PLANT,
REPORTS(WLHPS REPORT),
UNITS(IN=ENGLISH, OUT=ENGLISH);
TEMPORARY WALLS:
WALL1
= (A7 ,
  B1 ,
  PL4 ,
  IN3 ,
  PL4);
WALL2
= (PL4 ,
  B1 ,
  PL4);
END;
TEMPORARY ROOFS:
ROOF1
= (RF4 ,
  C14);
CEILING1
= (PL4 ,
  E4 ,
  IN3 ,
  PL4);
END;
TEMPORARY FLOORS:
FLOOR1
= (CO18 ,
  BM2 ,
  C5 ,
  FF1);
FLOOR2
= (PL4 ,
  E4 ,
  IN3 ,
  PL4);
END;
TEMPORARY DOORS:
DOOR1
= (ME2 ,
  B1 ,
  ME2);
END;
TEMPORARY SCHEDULE (FAN OPERATION):
MONDAY THRU FRIDAY=(0.00,0.00,0.00,0.00,0.00,0.00,0.00,0.00,0.00,0.00,1.00,1.00,
1.00,1.00,1.00,1.00,1.00,1.00,1.00,0.00,0.00,0.00,0.00,0.00,0.00,0.00,0.00),
SATURDAY=(0.00,0.00,0.00,0.00,0.00,0.00,0.00,0.00,0.00,0.00,0.00,0.00,0.00,
0.00,0.00,0.00,0.00,0.00,0.00,0.00,0.00,0.00,0.00,0.00,0.00,0.00,0.00,0.00),
SUNDAY=(0.00,0.00,0.00,0.00,0.00,0.00,0.00,0.00,0.00,0.00,0.00,0.00,0.00,
0.00,0.00,0.00,0.00,0.00,0.00,0.00,0.00,0.00,0.00,0.00,0.00,0.00,0.00),
HOLIDAY=(0.00,0.00,0.00,0.00,0.00,0.00,0.00,0.00,0.00,0.00,0.00,0.00,0.00,
0.00,0.00,0.00,0.00,0.00,0.00,0.00,0.00,0.00,0.00,0.00,0.00,0.00,0.00),
SPECIAL1=(0.00,0.00,0.00,0.00,0.00,0.00,0.00,0.00,0.00,0.00,0.00,0.00,0.00,
0.00,0.00,0.00,0.00,0.00,0.00,0.00,0.00,0.00,0.00,0.00,0.00,0.00,0.00),
SPECIAL2=(0.00,0.00,0.00,0.00,0.00,0.00,0.00,0.00,0.00,0.00,0.00,0.00,0.00,
0.00,0.00,0.00,0.00,0.00,0.00,0.00,0.00,0.00,0.00,0.00,0.00,0.00,0.00),
SPECIAL3=(0.00,0.00,0.00,0.00,0.00,0.00,0.00,0.00,0.00,0.00,0.00,0.00,0.00,
0.00,0.00,0.00,0.00,0.00,0.00,0.00,0.00,0.00,0.00,0.00,0.00,0.00,0.00),
SPECIAL4=(0.00,0.00,0.00,0.00,0.00,0.00,0.00,0.00,0.00,0.00,0.00,0.00,0.00,
0.00,0.00,0.00,0.00,0.00,0.00,0.00,0.00,0.00,0.00,0.00,0.00,0.00,0.00);
END;
TEMPORARY CONTROLS (DC):
PROFILES:
  BEG=(1.0000 AT 68.00, 0.0000 AT 69.00, 0.0000 AT 72.00,
    -1.0000 AT 73.00);
  SETBACK=(1.0 AT 60.0, 0.0 AT 61.0, 0.0 AT 80, -1.0 AT 81);
SCHEDULES:
  MONDAY THRU FRIDAY=(07 TO 17-BEG, 17 TO 07-SETBACK),
  SATURDAY=(0 TO 24-SETBACK),
  SUNDAY=(0 TO 24-SETBACK),
  HOLIDAY=(0 TO 24-SETBACK),
  SPECIAL1=(0 TO 24-BEG),

```

```

        SPECIAL2=(0 TO 24-BEG),
        SPECIAL3=(0 TO 24-BEG),
        SPECIAL4=(0 TO 24-BEG);
    END;
    PROJECT="DAYCARE CENTER";
    LOCATION=TULSA ;
**     DESIGN DAYS=TULSA SUMMER ,
**     TULSA WINTER ;
    WEATHER TAPE FROM 01JAN THRU 31DEC;
    GROUND TEMPERATURES=(55, 55, 55, 55, 55, 55, 55, 55, 55, 55, 55);
    CATEGORY CODE=74014;
    BEGIN BUILDING DESCRIPTION;
        BUILDING="DAYCARE CENTER ";
        NORTH AXIS=315.00;
        SOLAR DISTRIBUTION=-1;
** Zone 1 includes only the mechanical room next to the kitchen.
    ZONE 1 "MECHANICAL ROOM ":
        ORIGIN:(28.17, 5.92, 0.00);
        NORTH AXIS=0.00;
        EXTERIOR WALLS :
            STARTING AT(0.00, 0.00, 0.00)
            FACING(180.00)
            TILTED(90.00)
            WALL1 (11.42 BY 8.00),
            STARTING AT(11.42, 0.00, 0.00)
            FACING(90.00)
            TILTED(90.00)
            WALL1 (17.88 BY 8.00)
            WITH DOORS OF TYPE
            DOOR1 (5.00 BY 7.00)
            AT (1.00, 0.00);
        PARTITIONS :
            STARTING AT(11.42, 17.88, 0.00)
            FACING(0.00)
            TILTED(90.00)
            WALL1 (11.42 BY 8.00),
            STARTING AT(0.00, 17.88, 0.00)
            FACING(270.00)
            TILTED(90.00)
            WALL1 (17.88 BY 8.00);
        SLAB ON GRADE FLOORS :
            STARTING AT(0.00, 17.88, 0.00)
            FACING(180.00)
            TILTED(180.00)
            FLOOR1 (11.42 BY 17.88);
        INTERZONE CEILINGS :
            STARTING AT(0.00, 0.00, 8.00)
            FACING(180.00)
            TILTED(0.00)
            CEILING1 (11.42 BY 17.88)
            ADJACENT TO ZONE (6);
        OTHER =13.65,OFFICE OCCUPANCY ,
            85.00 PERCENT RADIANT, 15.00 PERCENT LATENT, 0.00 PERCENT LOST,
            FROM 01JAN THRU 31DEC;
            INFILTRATION=30.00,CONSTANT ,
            WITH COEFFICIENTS (0.606000, 0.020200, 0.000598, 0.000000),
            FROM 01JAN THRU 31DEC;
    END ZONE;
** Zone 2 includes the SMURF ROOM and the kitchen, bathroom,
** janitor and storage room close to the SMURF ROOM.
    ZONE 2 "SMURF ROOM ":
        ORIGIN:(9.75, 0.00, 0.00);
        NORTH AXIS=0.00;
        EXTERIOR WALLS :
            STARTING AT(0.00, 0.00, 0.00)
            FACING(180.00)
            TILTED(90.00)
            WALL1 (18.42 BY 8.00),
            STARTING AT(18.42, 0.00, 0.00)
            FACING(90.00)
            TILTED(90.00)
            WALL1 (5.92 BY 8.00)
            WITH WINDOWS OF TYPE
            SINGLE PANE HW WINDOW (1.00 BY 4.00)
            REVEAL(0.00)
            AT (0.75, 3.00)

```

```

        WITH DOORS OF TYPE
        DOOR1 (3.00 BY 7.00)
          AT (2.20, 0.00),
        STARTING AT(29.83, 23.79, 0.00)
        FACING(90.00)
        TILTED(90.00)
        WALL1 (20.21 BY 8.00),
        STARTING AT(0.00, 33.42, 0.00)
        FACING(270.00)
        TILTED(90.00)
        WALL1 (33.42 BY 8.00)
        WITH WINDOWS OF TYPE
        SINGLE PANE HW WINDOW (4.67 BY 4.00)
        REVEAL(0.00)
          AT (17.00, 3.00);
PARTITIONS :
        STARTING AT(29.83, 44.00, 0.00)
        FACING(0.00)
        TILTED(90.00)
        WALL2 (29.83 BY 8.00)
        WITH DOORS OF TYPE
        SWD (3.00 BY 7.00)
          AT (26.03, 0.00),
        STARTING AT(0.00, 44.00, 0.00)
        FACING(270.00)
        TILTED(90.00)
        WALL1 (10.58 BY 8.00);
WALL TO UNCOOLED SPACES:
        STARTING AT(18.42, 5.92, 0.00)
        FACING(90.00)
        TILTED(90.00)
        WALL1 (17.88 BY 8.00),
        STARTING AT(18.42, 23.79, 0.00)
        FACING(180.00)
        TILTED(90.00)
        WALL1 (11.42 BY 8.00);
SLAB ON GRADE FLOORS :
        STARTING AT(0.00, 39.18, 0.00)
        FACING(180.00)
        TILTED(180.00)
        FLOOR1 (26.57 BY 39.18);
INTERZONE CEILINGS :
        STARTING AT(0.00, 0.00, 8.00)
        FACING(180.00)
        TILTED(0.00)
        CEILING1 (25.57 BY 39.18)
        ADJACENT TO ZONE (6);
INTERNAL MASS: WALL2
        ( 85.00 BY 8.00);
PEOPLE=25,FAN OPERATION ,
        AT ACTIVITY LEVEL 0.45, 70.00 PERCENT RADIANT,
        FROM 01JAN THRU 31DEC;
LIGHTS=1.70,OFFICE LIGHTING ,
        0.00 PERCENT RETURN AIR, 20.00 PERCENT RADIANT,
        40.00 PERCENT VISIBLE, 40.00 PERCENT REPLACEABLE,
        FROM 01JAN THRU 31DEC;
OTHER =8.50,OFFICE OCCUPANCY ,
        40.00 PERCENT RADIANT, 20.00 PERCENT LATENT, 00.00 PERCENT LOST,
        FROM 01JAN THRU 31DEC;
**      VENTILATION=0.00,INTERMITTENT ,
**      65.00 MIN TEMP, 40.00 DEL TEMP,
**      FROM 01JAN THRU 31DEC;
CONTROLS=DC ,
        54 HEATING, 60 COOLING,
        45.00 PERCENT MRT,
        FROM 01JAN THRU 31DEC;
        INFILTRATION=140.00,CONSTANT ,
        WITH COEFFICIENTS (0.606000, 0.020200, 0.000598, 0.000000),
        FROM 01JAN THRU 31DEC;
END ZONE;
** Zone 3 includes the Reception the small office next to it and
** the hall way in between the reception and the Muppet room.
ZONE 3 "RECEPTION ":
        ORIGIN:(0.00, 33.42, 0.00);
        NORTH AXIS=0.00;
        EXTERIOR WALLS :

```

STARTING AT(0.00, 0.00, 0.00)
 FACING(180.00)
 TILTED(90.00)
 WALL2 (9.75 BY 8.00),
 STARTING AT(9.75, 42.67, 0.00)
 FACING(270.00)
 TILTED(90.00)
 WALL1 (10.92 BY 8.00),
 STARTING AT(9.75, 31.75, 0.00)
 FACING(0.00)
 TILTED(90.00)
 WALL1 (9.75 BY 8.00),
 STARTING AT(0.00, 31.75, 0.00)
 FACING(270.00)
 TILTED(90.00)
 WALL1 (10.58 BY 8.00),
 STARTING AT(0.00, 21.17, 0.00)
 FACING(270.00)
 TILTED(90.00)
 WALL2 (21.17 BY 8.00)
 WITH WINDOWS OF TYPE
 SINGLE PANE HW WINDOW (21.00 BY 0.70)
 REVEAL(0.00)
 AT (0.00, 7.20)
 WITH DOORS OF TYPE
 GLD (3.00 BY 7.00)
 AT (1.00, 0.00);
 PARTITIONS :
 STARTING AT(9.75, 0.00, 0.00)
 FACING(90.00)
 TILTED(90.00)
 WALL1 (10.58 BY 8.00),
 STARTING AT(9.75, 10.58, 0.00)
 FACING(180.00)
 TILTED(90.00)
 WALL2 (5.92 BY 8.00)
 WITH DOORS OF TYPE
 SWD (3.00 BY 7.00)
 AT (0.80, 0.00),
 STARTING AT(15.67, 10.58, 0.00)
 FACING(90.00)
 TILTED(90.00)
 WALL2 (34.83 BY 8.00)
 WITH DOORS OF TYPE
 SWD (3.00 BY 7.00)
 AT (0.50, 0.00)
 WITH DOORS OF TYPE
 SWD (3.00 BY 7.00)
 AT (17.00, 0.00)
 WITH DOORS OF TYPE
 SWD (3.00 BY 7.00)
 AT (21.25, 0.00),
 STARTING AT(9.75, 45.42, 0.00)
 FACING(270.00)
 TILTED(90.00)
 WALL1 (2.75 BY 8.00);
 SLAB ON GRADE FLOORS :
 STARTING AT(0.00, 38.71, 0.00)
 FACING(180.00)
 TILTED(180.00)
 FLOOR1 (13.32 BY 38.71);
 INTERZONE CEILINGS :
 STARTING AT(0.00, 0.00, 8.00)
 FACING(180.00)
 TILTED(0.00)
 CEILING1 (13.32 BY 38.71)
 ADJACENT TO ZONE (6);
 INTERNAL MASS: WALL2
 (23.00 BY 8.00);
 PEOPLE=10,FAN OPERATION ,
 AT ACTIVITY LEVEL 0.45, 70.00 PERCENT RADIANT,
 FROM 01JAN THRU 31DEC;
 LIGHTS=0.85,OFFICE LIGHTING ,
 0.00 PERCENT RETURN AIR, 20.00 PERCENT RADIANT,
 40.00 PERCENT VISIBLE, 40.00 PERCENT REPLACEABLE,
 FROM 01JAN THRU 31DEC;

```

OTHER =5.10,OFFICE OCCUPANCY ,
      40.00 PERCENT RADIANT, 10.00 PERCENT LATENT, 00.00 PERCENT LOST,
      FROM 01JAN THRU 31DEC;
**      VENTILATION=0.00,INTERMITTENT ,
**      65.00 MIN TEMP, 50.00 DEL TEMP,
**      FROM 01JAN THRU 31DEC;
CONTROLS=DC ,
      35 HEATING,38 COOLING,
      45.00 PERCENT MRT,
      FROM 01JAN THRU 31DEC;
      INFILTRATION=75.00,CONSTANT ,
      WITH COEFFICIENTS (0.606000, 0.020200, 0.000598, 0.000000),
      FROM 01JAN THRU 31DEC;
END ZONE;
** Zone 4 includes the Muppet room, the big office and storage room.
ZONE 4 "MUPPET ROOM ":
ORIGIN:(15.67, 44.00, 0.00);
NORTH AXIS=0.00;
EXTERIOR WALLS :
STARTING AT(23.92, 0.00, 0.00)
FACING(180.00)
TILTED(90.00)
WALL1 (20.67 BY 8.00)
WITH DOORS OF TYPE
DOOR1 (3.00 BY 7.00)
AT (2.38, 0.00)
WITH WINDOWS OF TYPE
SINGLE PANE HW WINDOW (1.00 BY 4.00)
REVEAL(0.00)
AT (5.75, 3.00),
STARTING AT(44.58, 0.00, 0.00)
FACING(90.00)
TILTED(90.00)
WALL1 (21.17 BY 8.00),
STARTING AT(44.58, 21.17, 0.00)
FACING(0.00)
TILTED(90.00)
WALL1 (20.67 BY 8.00)
WITH DOORS OF TYPE
DOOR1 (3.00 BY 7.00)
AT (5.00, 0.00),
STARTING AT(23.92, 21.17, 0.00)
FACING(90.00)
TILTED(90.00)
WALL1 (13.92 BY 8.00)
WITH DOORS OF TYPE
DOOR1 (3.00 BY 7.00)
AT (0.90, 0.00);
PARTITIONS :
STARTING AT(0.00, 0.00, 0.00)
FACING(180.00)
TILTED(90.00)
WALL2 (23.92 BY 8.00),
STARTING AT(23.92, 35.08, 0.00)
FACING(0.00)
TILTED(90.00)
WALL1 (23.92 BY 8.00),
STARTING AT(0.00, 35.08, 0.00)
FACING(270.00)
TILTED(90.00)
WALL2 (35.08 BY 8.00)
WITH DOORS OF TYPE
SWD (3.00 BY 7.00)
AT (10.50, 0.00)
WITH DOORS OF TYPE
SWD (3.00 BY 7.00)
AT (14.50, 0.00)
WITH DOORS OF TYPE
SWD (3.00 BY 7.00)
AT (31.00, 0.00);
SLAB ON GRADE FLOORS :
STARTING AT(0.00, 31.69, 0.00)
FACING(180.00)
TILTED(180.00)
FLOOR1 (40.28 BY 31.69);
INTERZONE CEILINGS :

```



```

STARTING AT(0.00, 0.00, 8.00)
FACING(180.00)
TILTED(0.00)
CEILING1 (40.28 BY 31.69)
ADJACENT TO ZONE (6);
INTERNAL MASS: WALL2
( 50.00 BY 8.00);
INTERNAL MASS: WALL1
( 34.00 BY 8.00);
PEOPLE=25,FAN OPERATION ,
AT ACTIVITY LEVEL 0.45, 70.00 PERCENT RADIANT,
FROM 01JAN THRU 31DEC;
LIGHTS=1.87,OFFICE LIGHTING ,
0.00 PERCENT RETURN AIR, 20.00 PERCENT RADIANT,
40.00 PERCENT VISIBLE, 40.00 PERCENT REPLACEABLE,
FROM 01JAN THRU 31DEC;
OTHER =8.50,OFFICE OCCUPANCY ,
40.00 PERCENT RADIANT, 5.00 PERCENT LATENT, 0.00 PERCENT LOST,
FROM 01JAN THRU 31DEC;
** VENTILATION=0.00,INTERMITTENT ,
** 32.00 MIN TEMP, 00.00 DEL TEMP,
** FROM 01JAN THRU 31DEC;
CONTROLS=DC ,
57 HEATING, 57 COOLING,
45.00 PERCENT MRT,
FROM 01JAN THRU 31DEC;
INFILTRATION=124.00,CONSTANT ,
WITH COEFFICIENTS (0.606000, 0.020200, 0.000598, 0.000000),
FROM 01JAN THRU 31DEC;
END ZONE;
** Zone 5 includes the Super friends room, the Shirt Tales room,
** the explorer room, the hall way connecting all three of theses
** rooms and the bathroom next to the Super friends room.
ZONE 5 "SHORT TALES ROOM ":
ORIGIN:(0.00, 76.08, 0.00);
NORTH AXIS=0.00;
EXTERIOR WALLS :
STARTING AT(0.00, 0.00, 0.00)
FACING(180.00)
TILTED(90.00)
WALL1 (9.75 BY 8.00),
STARTING AT(39.58, 2.75, 0.00)
FACING(180.00)
TILTED(90.00)
WALL1 (20.67 BY 8.00)
WITH DOORS OF TYPE
MID (3.50 BY 7.00)
AT (0.75, 0.00),
STARTING AT(60.25, 2.75, 0.00)
FACING(90.00)
TILTED(90.00)
WALL1 (29.92 BY 8.00)
WITH WINDOWS OF TYPE
SINGLE PANE HW WINDOW (2.33 BY 4.00)
REVEAL(0.00)
AT (6.00, 3.00),
STARTING AT(60.25, 32.67, 0.00)
FACING(0.00)
TILTED(90.00)
WALL1 (60.25 BY 8.00)
WITH WINDOWS OF TYPE
SINGLE PANE HW WINDOW (7.00 BY 4.00)
REVEAL(0.00)
AT (30.00, 3.00)
WITH DOORS OF TYPE
MID (3.00 BY 7.00)
AT (1.00, 0.00)
WITH DOORS OF TYPE
MID (3.00 BY 7.00)
AT (20.60, 0.00)
WITH DOORS OF TYPE
MID (3.00 BY 7.00)
AT (45.75, 0.00),
STARTING AT(0.00, 32.67, 0.00)
FACING(270.00)
TILTED(90.00)

```

```

WALL1 (32.67 BY 8.00)
  WITH WINDOWS OF TYPE
    SINGLE PANE HW WINDOW (2.33 BY 4.00)
    REVEAL(0.00)
    AT (24.07, 3.00);
PARTITIONS :
  STARTING AT(9.75, 0.00, 0.00)
  FACING(90.00)
  TILTED(90.00)
  WALL1 (2.75 BY 8.00),
  STARTING AT(15.67, 2.75, 0.00)
  FACING(180.00)
  TILTED(90.00)
  WALL1 (23.92 BY 8.00);
SLAB ON GRADE FLOORS :
  STARTING AT(0.00, 30.00, 0.00)
  FACING(180.00)
  TILTED(180.00)
  FLOOR1 (60.98 BY 30.00);
INTERZONE CEILINGS :
  STARTING AT(0.00, 0.00, 8.00)
  FACING(180.00)
  TILTED(0.00)
  CEILING1 (60.98 BY 30.00)
  ADJACENT TO ZONE (6);
INTERNAL MASS: WALL2
  ( 325.00 BY 8.00);
PEOPLE=30,FAN OPERATION ,
  AT ACTIVITY LEVEL 0.45, 70.00 PERCENT RADIANT,
  FROM 01JAN THRU 31DEC;
LIGHTS=2.04,OFFICE LIGHTING ,
  0.00 PERCENT RETURN AIR, 20.00 PERCENT RADIANT,
  40.00 PERCENT VISIBLE, 40.00 PERCENT REPLACEABLE,
  FROM 01JAN THRU 31DEC;
OTHER =5.10,OFFICE OCCUPANCY ,
  40.00 PERCENT RADIANT, 5.00 PERCENT LATENT, 0.00 PERCENT LOST,
  FROM 01JAN THRU 31DEC;
**   VENTILATION=0.00,INTERMITTENT ,
**   15.00 MIN TEMP, 00.00 DEL TEMP,
**   FROM 01JAN THRU 31DEC;
CONTROLS=DC ,
  91 HEATING, 72 COOLING,
  45.00 PERCENT MRT,
  FROM 01JAN THRU 31DEC;
  INFILTRATION=248.00,CONSTANT ,
  WITH COEFFICIENTS (0.606000, 0.020200, 0.000598, 0.000000),
  FROM 01JAN THRU 31DEC;
END ZONE;
** This last Zone is the space between the false ceiling and the roof.
  ZONE 6 "ATTIC " :
  ORIGIN:(0.00, 0.00, 0.00);
  NORTH AXIS=0.00;
  EXTERIOR WALLS :
    STARTING AT(9.75, 0.00, 8.00)
    FACING(180.00)
    TILTED(90.00)
    WALL1 (18.42 BY 5.00),
    STARTING AT(28.17, 0.00, 8.00)
    FACING(90.00)
    TILTED(90.00)
    WALL1 (5.92 BY 5.00),
    STARTING AT(28.17, 5.92, 8.00)
    FACING(180.00)
    TILTED(90.00)
    WALL1 (11.42 BY 5.00),
    STARTING AT(39.58, 5.92, 8.00)
    FACING(90.00)
    TILTED(90.00)
    WALL1 (38.08 BY 5.00),
    STARTING AT(39.58, 44.00, 8.00)
    FACING(180.00)
    TILTED(90.00)
    WALL1 (20.67 BY 5.00),
    STARTING AT(60.25, 44.00, 8.00)
    FACING(90.00)
    TILTED(90.00)

```

WALL1 (21.17 BY 5.00),
 STARTING AT(60.25, 65.17, 8.00)
 FACING(0.00)
 TILTED(90.00)
 WALL1 (20.67 BY 5.00),
 STARTING AT(39.58, 65.17, 8.00)
 FACING(90.00)
 TILTED(90.00)
 WALL1 (13.92 BY 5.00),
 STARTING AT(39.58, 79.08, 8.00)
 FACING(180.00)
 TILTED(90.00)
 WALL1 (20.67 BY 5.00),
 STARTING AT(60.25, 79.08, 8.00)
 FACING(90.00)
 TILTED(90.00)
 WALL1 (29.92 BY 5.00),
 STARTING AT(60.25, 109.00, 8.00)
 FACING(0.00)
 TILTED(90.00)
 WALL1 (60.25 BY 5.00),
 STARTING AT(0.00, 109.00, 8.00)
 FACING(270.00)
 TILTED(90.00)
 WALL1 (32.67 BY 5.00),
 STARTING AT(0.00, 76.33, 8.00)
 FACING(180.00)
 TILTED(90.00)
 WALL1 (9.75 BY 5.00),
 STARTING AT(9.75, 76.33, 8.00)
 FACING(270.00)
 TILTED(90.00)
 WALL1 (11.17 BY 5.00),
 STARTING AT(9.75, 65.17, 8.00)
 FACING(0.00)
 TILTED(90.00)
 WALL1 (9.75 BY 5.00),
 STARTING AT(0.00, 65.17, 8.00)
 FACING(270.00)
 TILTED(90.00)
 WALL1 (10.58 BY 5.00),
 STARTING AT(0.00, 54.58, 8.00)
 FACING(270.00)
 TILTED(90.00)
 WALL2 (21.17 BY 5.00),
 STARTING AT(0.00, 33.42, 8.00)
 FACING(180.00)
 TILTED(90.00)
 WALL1 (9.75 BY 5.00),
 STARTING AT(9.75, 33.42, 8.00)
 FACING(270.00)
 TILTED(90.00)
 WALL1 (33.42 BY 5.00);
 INTERZONE FLOORS :
 STARTING AT(28.17, 23.79, 8.00)
 FACING(180.00)
 TILTED(180.00)
 FLOOR2 (11.42 BY 17.88)
 ADJACENT TO ZONE (1),
 STARTING AT(9.75, 39.18, 8.00)
 FACING(180.00)
 TILTED(180.00)
 FLOOR2 (25.57 BY 39.18)
 ADJACENT TO ZONE (2),
 STARTING AT(0.00, 72.13, 8.00)
 FACING(180.00)
 TILTED(180.00)
 FLOOR2 (13.32 BY 38.71)
 ADJACENT TO ZONE (3),
 STARTING AT(15.67, 75.69, 8.00)
 FACING(180.00)
 TILTED(180.00)
 FLOOR2 (40.28 BY 31.69)
 ADJACENT TO ZONE (4),
 STARTING AT(0.00, 106.08, 8.00)
 FACING(180.00)

```

        TILTED(180.00)
        FLOOR2 (60.98 BY 30.00)
        ADJACENT TO ZONE (5);
    ROOFS :
        STARTING AT(5.00, 7.00, 13.00)
        FACING(180.00)
        TILTED(0.00)
        ROOF1 (50.00 BY 97.00);
        INFILTRATION=400.00,CONSTANT ,
        WITH COEFFICIENTS (0.606000, 0.020200, 0.000598, 0.000000),
        FROM 01JAN THRU 31DEC;
    END ZONE;
END BUILDING DESCRIPTION;
BEGIN FAN SYSTEM DESCRIPTION;
WATER LOOP HEAT PUMP SYSTEM 1
"WATER LOOP SYSTEM " SERVING ZONES
    2, 3, 4, 5;
    FOR ZONE 2:
        SUPPLY AIR VOLUME=375;
        EXHAUST AIR VOLUME=0.0;
        BASEBOARD HEAT CAPACITY=0.0;
        BASEBOARD HEAT ENERGY SUPPLY=HOT WATER;
        HEAT PUMP FLOW RATE=6000;
        HEAT PUMP CAPACITY=60;
        HEAT PUMP EER=9.0;
        HEAT PUMP COP=3.6;
        ZONE MULTIPLIER=1;
    END ZONE;
    FOR ZONE 3:
        SUPPLY AIR VOLUME=150;
        EXHAUST AIR VOLUME=0.0;
        BASEBOARD HEAT CAPACITY=0.0;
        BASEBOARD HEAT ENERGY SUPPLY=HOT WATER;
        HEAT PUMP FLOW RATE=3800;
        HEAT PUMP CAPACITY=38;
        HEAT PUMP EER=12.0;
        HEAT PUMP COP=4.4;
        ZONE MULTIPLIER=1;
    END ZONE;
    FOR ZONE 4:
        SUPPLY AIR VOLUME=375;
        EXHAUST AIR VOLUME=0.0;
        BASEBOARD HEAT CAPACITY=0.0;
        BASEBOARD HEAT ENERGY SUPPLY=HOT WATER;
        HEAT PUMP FLOW RATE=5700;
        HEAT PUMP CAPACITY=57;
        HEAT PUMP EER=9.0;
        HEAT PUMP COP=3.6;
        ZONE MULTIPLIER=1;
    END ZONE;
    FOR ZONE 5:
        SUPPLY AIR VOLUME=450;
        EXHAUST AIR VOLUME=0.0;
        BASEBOARD HEAT CAPACITY=0.0;
        BASEBOARD HEAT ENERGY SUPPLY=HOT WATER;
        HEAT PUMP FLOW RATE=9100;
        HEAT PUMP CAPACITY=91;
        HEAT PUMP EER=12.0;
        HEAT PUMP COP=4.2;
        ZONE MULTIPLIER=1;
    END ZONE;
OTHER SYSTEM PARAMETERS:
    SUPPLY FAN PRESSURE=2.48914;
    SUPPLY FAN EFFICIENCY=0.7;
    RETURN FAN PRESSURE=0.0;
    RETURN FAN EFFICIENCY=0.7;
    EXHAUST FAN PRESSURE=1.00396;
    EXHAUST FAN EFFICIENCY=0.7;
    COLD DECK CONTROL=FIXED SET POINT;
    COLD DECK TEMPERATURE=60.0;
    COLD DECK THROTTLING RANGE=1.8;
    COLD DECK CONTROL SCHEDULE=(80.0 AT 90.0, 90.0 AT 70.0);
    HEATING COIL ENERGY SUPPLY=HOT WATER;
    HEATING COIL CAPACITY=3412000;
    HOT DECK CONTROL=FIXED SET POINT;
    HOT DECK TEMPERATURE=80.0;

```

```

HOT DECK THROTTLING RANGE=1.8;
HOT DECK CONTROL SCHEDULE=(50.0 AT 0.0, 40.0 AT 70.0);
MIXED AIR CONTROL=FIXED PERCENT;
DESIRED MIXED AIR TEMPERATURE=74;
OUTSIDE AIR VOLUME=0.0;
GAS BURNER EFFICIENCY=0.8;
SYSTEM ELECTRICAL DEMAND=0.0;
LOOP MASS RATIO=0.5;
SYSTEM PRESSURE HEAD=401.474213311;
LOOP PUMP EFFICIENCY=0.85;
TANK TEMPERATURE=73.65;
FIXED LOOP TEMPERATURE=69.5;
MAXIMUM LOOP TEMPERATURE=86;
MINIMUM LOOP TEMPERATURE=69.8;
STORAGE VOLUME=0.0;
SUPPLEMENTAL HEAT TYPE=HOT WATER;
SUPPLEMENTAL COOL TYPE=COMPRESSION;
NOMINAL FLOW RATE=100;
NOMINAL PRESSURE DROP=0.004014742;
LOOP MASS=1230;
LOOP CONTROL=FIXED TEMPERATURE;
COOLING TOWER CAPACITY=3414425.0;
TOWER ELECTRIC COEFFICIENT=0.241;
TOWER PUMP COEFFICIENT=0.013;
PUMP TYPE=VARIABLE FLOW;
END OTHER SYSTEM PARAMETERS;
** IF ANY ONE OF THE FOLLOWING BLOCK IS CHANGED, CHANGE THE REST ACCORDINGLY **
COOLING COIL DESIGN PARAMETERS:
COIL TYPE=CHILLED WATER;
AIR VOLUME FLOW RATE=0.0000;
BAROMETRIC PRESSURE=405.489;
AIR FACE VELOCITY=492.126;
ENTERING AIR DRY BULB TEMPERATURE=84.92;
ENTERING AIR WET BULB TEMPERATURE=64.04;
LEAVING AIR DRY BULB TEMPERATURE=55.04;
LEAVING AIR WET BULB TEMPERATURE=52.7;
ENTERING WATER TEMPERATURE=44.96;
LEAVING WATER TEMPERATURE=55.04;
WATER VOLUME FLOW RATE=0.0000000;
WATER VELOCITY=275.59;
END COOLING COIL DESIGN PARAMETERS;
HEAT RECOVERY PARAMETERS:
HTREC1(0.85,0.0,0.0);
HTREC2(0.0,0.0,0.0);
HTREC3(0.0,0.0,0.0);
HTREC4(0.0,0.0,0.0);
HTREC5(0.0,0.0,0.0);
HTREC6(0.0,0.0,0.0);
HTPWR(0.0,0.0,0.0);
HEAT RECOVERY CAPACITY=3412000;
END HEAT RECOVERY PARAMETERS;
WATER SOURCE HEAT PUMP PARAMETERS:
HHCP(-3.6975,4.3774,0.0745);
HCCP(3.1175,-2.07,0.07459);
HCOP(-1.1105,1.93,0.107);
HEER(7.5,-6.3,0.216337);
PRSURE(0.0,0.0,0.0);
WLPT(0.0,1.0,0.0);
END WATER SOURCE HEAT PUMP PARAMETERS;
EQUIPMENT SCHEDULES:
SYSTEM OPERATION= FAN OPERATION, FROM 01JAN THRU 31DEC;
EXHAUST FAN OPERATION=FAN OPERATION, FROM 01JAN THRU 31DEC;
HEATING COIL OPERATION=OFF, FROM 01JAN THRU 31DEC;
COOLING COIL OPERATION=OFF, FROM 01JAN THRU 31DEC;
TSTAT BASEBOARD HEAT OPERATION=OFF, FROM 01JAN THRU 31DEC;
HEAT RECOVERY OPERATION=OFF, FROM 01JAN THRU 31DEC;
MAXIMUM VENTILATION SCHEDULE=FAN OPERATION, FROM 01JAN THRU 31DEC;
MINIMUM VENTILATION SCHEDULE=FAN OPERATION, FROM 01JAN THRU 31DEC;
SYSTEM ELECTRICAL DEMAND SCHEDULE=ON, FROM 01JAN THRU 31DEC;
WLHPS STORAGE TANK OPERATION=OFF, FROM 01JAN THRU 31DEC;
WLHPS VENTILATION SYSTEM OPERATION=FAN OPERATION, FROM 01JAN THRU 31DEC;
WLHPS LOOP CONTROL SCHEDULE=OFF, FROM 01JAN THRU 31DEC;
END EQUIPMENT SCHEDULES;
END SYSTEM;
END FAN SYSTEM DESCRIPTION;
END INPUT;

```

APPENDIX E.3

TABLES OF THE DAYCARE CENTER LOADS ON THE HEAT PUMPS

LOCATION: TULSA OKLAHOMA
 OZONE: 2 SMURF ROOM
 ENVIRONMENT TULSA OKLAHOMA WINTER

DAYCARE CENTER
 1 DAYS

DATE 21 JAN (MONDAY)

0 HR	HEATING LOAD 1000BTU	COOLING LOAD 1000BTU	INTENT LOAD 1000BTU	RETURN AIR HEAT GAIN 1000BTU	BASEBOARD LOAD 1000BTU	ELECTRIC LOAD 1000BTU	GAS LOAD 1000BTU	INFILTRATION HEAT LOSS 1000BTU	INFILTRATION HEAT GAIN 1000BTU	TEMPERATURES MAT DEG. F	ODB DEG. F	OWB DEG. F
1	2.322E+01	0.000E+00	0.000E+00	0.000E+00	0.000E+00	8.500E-02	0.000E+00	1.714E+01	0.000E+00	62.04	13.00	13.00
2	2.324E+01	0.000E+00	0.000E+00	0.000E+00	0.000E+00	8.500E-02	0.000E+00	1.714E+01	0.000E+00	62.05	13.00	13.00
3	2.328E+01	0.000E+00	0.000E+00	0.000E+00	0.000E+00	8.500E-02	0.000E+00	1.715E+01	0.000E+00	62.06	13.00	13.00
4	2.331E+01	0.000E+00	0.000E+00	0.000E+00	0.000E+00	8.500E-02	0.000E+00	1.715E+01	0.000E+00	62.07	13.00	13.00
5	2.334E+01	0.000E+00	0.000E+00	0.000E+00	0.000E+00	8.500E-02	0.000E+00	1.716E+01	0.000E+00	62.07	13.00	13.00
6	2.336E+01	0.000E+00	0.000E+00	0.000E+00	0.000E+00	8.500E-02	0.000E+00	1.716E+01	0.000E+00	62.08	13.00	13.00
7	2.267E+01	0.000E+00	1.700E-01	0.000E+00	0.000E+00	3.400E-01	0.000E+00	1.714E+01	0.000E+00	62.04	13.00	13.00
8	3.370E+01	0.000E+00	8.500E-01	0.000E+00	0.000E+00	1.700E+00	0.000E+00	2.067E+01	0.000E+00	72.15	13.00	13.00
9	2.218E+01	0.000E+00	6.196E+00	0.000E+00	0.000E+00	1.700E+00	0.000E+00	2.122E+01	0.000E+00	70.24	13.00	13.00
10	1.834E+01	0.000E+00	5.790E+00	0.000E+00	0.000E+00	1.700E+00	0.000E+00	2.181E+01	0.000E+00	69.58	13.00	13.00
11	1.688E+01	0.000E+00	5.654E+00	0.000E+00	0.000E+00	1.700E+00	0.000E+00	2.122E+01	0.000E+00	69.32	13.00	13.00
12	1.620E+01	0.000E+00	5.601E+00	0.000E+00	0.000E+00	1.700E+00	0.000E+00	2.101E+01	0.000E+00	69.20	13.00	13.00
13	1.877E+01	0.000E+00	4.725E+00	0.000E+00	0.000E+00	1.700E+00	0.000E+00	2.096E+01	0.000E+00	69.36	13.00	13.00
14	1.634E+01	0.000E+00	5.608E+00	0.000E+00	0.000E+00	1.700E+00	0.000E+00	2.091E+01	0.000E+00	69.22	13.00	13.00
15	1.593E+01	0.000E+00	5.580E+00	0.000E+00	0.000E+00	1.700E+00	0.000E+00	2.088E+01	0.000E+00	69.14	13.00	13.00
16	1.585E+01	0.000E+00	5.564E+00	0.000E+00	0.000E+00	1.700E+00	0.000E+00	2.088E+01	0.000E+00	69.13	13.00	13.00
17	1.952E+01	0.000E+00	4.712E+00	0.000E+00	0.000E+00	1.700E+00	0.000E+00	2.092E+01	0.000E+00	69.31	13.00	13.00
18	1.425E+01	0.000E+00	1.700E-01	0.000E+00	0.000E+00	8.500E-01	0.000E+00	1.757E+01	0.000E+00	60.20	13.00	13.00
19	1.946E+01	0.000E+00	0.000E+00	0.000E+00	0.000E+00	8.500E-01	0.000E+00	1.757E+01	0.000E+00	61.35	13.00	13.00
20	2.192E+01	0.000E+00	0.000E+00	0.000E+00	0.000E+00	8.500E-02	0.000E+00	1.662E+01	0.000E+00	61.35	13.00	13.00
21	2.268E+01	0.000E+00	0.000E+00	0.000E+00	0.000E+00	8.500E-02	0.000E+00	1.695E+01	0.000E+00	61.80	13.00	13.00
22	2.300E+01	0.000E+00	0.000E+00	0.000E+00	0.000E+00	8.500E-02	0.000E+00	1.707E+01	0.000E+00	61.94	13.00	13.00
23	2.311E+01	0.000E+00	0.000E+00	0.000E+00	0.000E+00	8.500E-02	0.000E+00	1.711E+01	0.000E+00	62.00	13.00	13.00
24	2.317E+01	0.000E+00	0.000E+00	0.000E+00	0.000E+00	8.500E-02	0.000E+00	1.713E+01	0.000E+00	62.02	13.00	13.00
OTOT	5.027E+02	0.000E+00	5.062E+01	0.000E+00	0.000E+00	1.921E+01	0.000E+00	4.498E+02	0.000E+00	62.03	13.00	13.00

HEATING LOAD = 4.829E-01 1000BTU /FT**2 COOLING LOAD = 0.000E+00 1000BTU /FT**2 ZONE FLOOR AREA = 1.041E+03 FT**2

MAX HEATING LOAD = 3.370E+01 1000BTU/HR AT HOUR 8 WITH ZONE AIR TEMP OF 72.15 DEG. F

MAX COOLING LOAD = 0.000E+00 1000BTU/HR AT HOUR 0 WITH ZONE AIR TEMP OF 0.00 DEG. F

MAX ZONE AIR TEMP = 72.15 DEG. F AT HOUR 8

MIN ZONE AIR TEMP = 60.20 DEG. F AT HOUR 18

1 US ARMY CORES OF ENGINEERS -- BLAST VERSION 3.0 (ANSI FORTRAN 77) LEVEL 215 28 AUG 95 12.34.24 PAGE 35

OZONE LOADS REPORT DAYCARE CENTER

LOCATION: TULSA OKLAHOMA
 OZONE: 2 SMURF ROOM
 ENVIRONMENT TULSA OKLAHOMA SUMMER

DAYCARE CENTER
 1 DAYS

DATE 21 JUL (MONDAY)

0 HR	HEATING LOAD 1000BTU	COOLING LOAD 1000BTU	LATENT LOAD 1000BTU	RETURN AIR HEAT GAIN 1000BTU	RASBOARD LOAD 1000BTU	ELECTRIC LOAD 1000BTU	GAS LOAD 1000BTU	INFILT HEAT LOSS 1000BTU	INFILT HEAT GAIN 1000BTU	MAT DEG. F	TEMPERATURES ODB DEG. F	OMB DEG. F
1	0.000E+00	0.000E+00	0.000E+00	0.000E+00	0.000E+00	8.500E-02	0.000E+00	0.000E+00	0.000E+00	71.84	77.12	69.15
2	0.000E+00	0.000E+00	0.000E+00	0.000E+00	0.000E+00	8.500E-02	0.000E+00	0.000E+00	0.000E+00	70.97	75.92	68.79
3	0.000E+00	0.000E+00	0.000E+00	0.000E+00	0.000E+00	8.500E-02	0.000E+00	0.000E+00	0.000E+00	70.17	74.96	68.50
4	0.000E+00	0.000E+00	0.000E+00	0.000E+00	0.000E+00	8.500E-02	0.000E+00	0.000E+00	0.000E+00	69.59	74.24	68.28
5	0.000E+00	0.000E+00	0.000E+00	0.000E+00	0.000E+00	8.500E-02	0.000E+00	0.000E+00	0.000E+00	69.06	74.00	68.21
6	0.000E+00	0.000E+00	0.000E+00	0.000E+00	0.000E+00	8.500E-02	0.000E+00	0.000E+00	0.000E+00	68.84	74.48	68.35
7	0.000E+00	0.000E+00	1.700E-01	0.000E+00	0.000E+00	3.400E-01	0.000E+00	0.000E+00	0.000E+00	69.10	75.68	68.72
8	0.000E+00	0.000E+00	8.500E-01	0.000E+00	0.000E+00	1.700E+00	0.000E+00	0.000E+00	0.000E+00	72.64	77.84	69.36
9	0.000E+00	1.007E+01	6.304E+00	0.000E+00	0.000E+00	1.700E+00	0.000E+00	0.000E+00	1.534E+00	71.79	80.96	70.28
10	0.000E+00	1.211E+01	6.119E+00	0.000E+00	0.000E+00	1.700E+00	0.000E+00	0.000E+00	2.399E+00	71.10	84.56	71.32
11	0.000E+00	1.464E+01	5.973E+00	0.000E+00	0.000E+00	1.700E+00	0.000E+00	0.000E+00	3.101E+00	70.82	88.64	72.47
12	0.000E+00	1.614E+01	5.910E+00	0.000E+00	0.000E+00	1.700E+00	0.000E+00	0.000E+00	4.151E+00	70.65	92.48	73.52
13	0.000E+00	1.520E+01	5.026E+00	0.000E+00	0.000E+00	1.700E+00	0.000E+00	0.000E+00	5.093E+00	70.68	95.36	74.30
14	0.000E+00	1.902E+01	5.881E+00	0.000E+00	0.000E+00	1.700E+00	0.000E+00	0.000E+00	5.668E+00	70.37	97.28	74.81
15	0.000E+00	2.010E+01	5.817E+00	0.000E+00	0.000E+00	1.700E+00	0.000E+00	0.000E+00	5.935E+00	70.15	98.00	75.00
16	0.000E+00	2.081E+01	5.770E+00	0.000E+00	0.000E+00	1.700E+00	0.000E+00	0.000E+00	5.786E+00	69.99	97.28	74.81
17	0.000E+00	1.779E+01	4.888E+00	0.000E+00	0.000E+00	1.700E+00	0.000E+00	0.000E+00	5.312E+00	70.14	95.60	74.36
18	0.000E+00	0.000E+00	1.700E-01	0.000E+00	0.000E+00	8.500E-01	0.000E+00	0.000E+00	0.000E+00	78.42	92.96	73.65
19	0.000E+00	0.000E+00	0.000E+00	0.000E+00	0.000E+00	8.500E-02	0.000E+00	0.000E+00	0.000E+00	78.17	89.84	72.80
20	0.000E+00	0.000E+00	0.000E+00	0.000E+00	0.000E+00	8.500E-02	0.000E+00	0.000E+00	0.000E+00	77.02	86.72	71.93
21	0.000E+00	0.000E+00	0.000E+00	0.000E+00	0.000E+00	8.500E-02	0.000E+00	0.000E+00	0.000E+00	75.91	84.08	71.18
22	0.000E+00	0.000E+00	0.000E+00	0.000E+00	0.000E+00	8.500E-02	0.000E+00	0.000E+00	0.000E+00	74.77	81.68	70.49
23	0.000E+00	0.000E+00	0.000E+00	0.000E+00	0.000E+00	8.500E-02	0.000E+00	0.000E+00	0.000E+00	73.66	79.76	69.93
24	0.000E+00	0.000E+00	0.000E+00	0.000E+00	0.000E+00	8.500E-02	0.000E+00	0.000E+00	0.000E+00	72.73	78.32	69.50
OTOT	0.000E+00	1.465E+02	5.287E+01	0.000E+00	0.000E+00	1.921E+01	0.000E+00	0.000E+00	3.946E+01			
HEATING LOAD = 0.000E+00 1000BTU /FT**2 COOLING LOAD = 1.407E-01 1000BTU /FT**2 ZONE FLOOR AREA = 1.041E+03 FT**2												
OPEAK LOADS AND TEMPERATURES:												
MAX HEATING LOAD = 0.000E+00 1000BTU/HR AT HOUR 24 WITH ZONE AIR TEMP OF 72.73 DEG. F												
MAX COOLING LOAD = 2.081E+01 1000BTU/HR AT HOUR 16 WITH ZONE AIR TEMP OF 69.99 DEG. F												
MAX ZONE AIR TEMP = 78.42 DEG. F AT HOUR 18												
MIN ZONE AIR TEMP = 68.84 DEG. F AT HOUR 6												

ZONE LOADS REPORT

DAYCARE CENTER

LOCATION: TULSA OKLAHOMA
 ZONE: 3 RECEPTION
 ENVIRONMENT TULSA OKLAHOMA WINTER

DAYCARE CENTER
 1 DAYS

DATE	HR	HEATING LOAD	COOLING LOAD	LATENT LOAD	RETURN AIR HEAT GAIN	BASEBOARD LOAD	ELECTRIC LOAD	GAS LOAD	INFILT HEAT LOSS	INFILT HEAT GAIN	TEMPERATURES
		1000BTU	1000BTU	1000BTU	1000BTU	1000BTU	1000BTU	1000BTU	1000BTU	1000BTU	DEG. F
21 JAN	1	1.679E+01	0.000E+00	0.000E+00	0.000E+00	0.000E+00	4.250E-02	0.000E+00	9.504E+00	0.000E+00	63.50 13.00
	2	1.681E+01	0.000E+00	0.000E+00	0.000E+00	0.000E+00	4.250E-02	0.000E+00	9.506E+00	0.000E+00	63.50 13.00
	3	1.683E+01	0.000E+00	0.000E+00	0.000E+00	0.000E+00	4.250E-02	0.000E+00	9.508E+00	0.000E+00	63.51 13.00
	4	1.685E+01	0.000E+00	0.000E+00	0.000E+00	0.000E+00	4.250E-02	0.000E+00	9.511E+00	0.000E+00	63.52 13.00
	5	1.686E+01	0.000E+00	0.000E+00	0.000E+00	0.000E+00	4.250E-02	0.000E+00	9.512E+00	0.000E+00	63.53 13.00
	6	1.687E+01	0.000E+00	0.000E+00	0.000E+00	0.000E+00	4.250E-02	0.000E+00	9.514E+00	0.000E+00	63.53 13.00
	7	1.643E+01	0.000E+00	5.100E-02	0.000E+00	0.000E+00	4.250E-01	0.000E+00	9.606E+00	0.000E+00	63.59 13.00
	8	2.274E+01	0.000E+00	2.550E-01	0.000E+00	0.000E+00	8.500E-01	0.000E+00	1.156E+01	0.000E+00	73.89 13.00
	9	1.704E+01	0.000E+00	2.463E+00	0.000E+00	0.000E+00	8.500E-01	0.000E+00	1.197E+01	0.000E+00	72.20 13.00
	10	1.521E+01	0.000E+00	2.313E+00	0.000E+00	0.000E+00	8.500E-01	0.000E+00	1.187E+01	0.000E+00	71.40 13.00
	11	1.451E+01	0.000E+00	2.263E+00	0.000E+00	0.000E+00	8.500E-01	0.000E+00	1.182E+01	0.000E+00	71.28 13.00
	12	1.415E+01	0.000E+00	2.244E+00	0.000E+00	0.000E+00	8.500E-01	0.000E+00	1.184E+01	0.000E+00	71.44 13.00
	13	1.591E+01	0.000E+00	1.978E+00	0.000E+00	0.000E+00	8.500E-01	0.000E+00	1.183E+01	0.000E+00	71.29 13.00
	14	1.420E+01	0.000E+00	2.247E+00	0.000E+00	0.000E+00	8.500E-01	0.000E+00	1.180E+01	0.000E+00	71.21 13.00
	15	1.397E+01	0.000E+00	2.234E+00	0.000E+00	0.000E+00	8.500E-01	0.000E+00	1.179E+01	0.000E+00	71.20 13.00
	16	1.392E+01	0.000E+00	2.228E+00	0.000E+00	0.000E+00	8.500E-01	0.000E+00	1.182E+01	0.000E+00	71.37 13.00
	17	1.575E+01	0.000E+00	1.971E+00	0.000E+00	0.000E+00	8.500E-01	0.000E+00	9.899E+00	0.000E+00	63.80 13.00
	18	1.201E+01	0.000E+00	5.100E-02	0.000E+00	0.000E+00	4.250E-02	0.000E+00	9.324E+00	0.000E+00	62.90 13.00
	19	1.474E+01	0.000E+00	0.000E+00	0.000E+00	0.000E+00	4.250E-02	0.000E+00	9.470E+00	0.000E+00	63.30 13.00
	20	1.593E+01	0.000E+00	0.000E+00	0.000E+00	0.000E+00	4.250E-02	0.000E+00	9.551E+00	0.000E+00	63.45 13.00
	21	1.639E+01	0.000E+00	0.000E+00	0.000E+00	0.000E+00	4.250E-02	0.000E+00	9.581E+00	0.000E+00	63.53 13.00
	22	1.662E+01	0.000E+00	0.000E+00	0.000E+00	0.000E+00	4.250E-02	0.000E+00	9.594E+00	0.000E+00	63.56 13.00
	23	1.671E+01	0.000E+00	0.000E+00	0.000E+00	0.000E+00	4.250E-02	0.000E+00	9.599E+00	0.000E+00	63.58 13.00
	24	1.675E+01	0.000E+00	0.000E+00	0.000E+00	0.000E+00	4.250E-02	0.000E+00	9.599E+00	0.000E+00	63.58 13.00
TOT	3	84.0E+02	0.000E+00	2.030E+01	0.000E+00	0.000E+00	9.605E+00	0.000E+00	2.529E+02	0.000E+00	

HEATING LOAD = 7.447E+01 1000BTU /FT**2 COOLING LOAD = 0.000E+00 1000BTU /FT**2 ZONE FLOOR AREA = 5.156E+02 FT**2

OPK LOADS AND TEMPERATURES:
 MAX HEATING LOAD = 2.274E+01 1000BTU/HR AT HOUR 8 WITH ZONE AIR TEMP OF 73.89 DEG. F
 MAX COOLING LOAD = 0.000E+00 1000BTU/HR AT HOUR 0 WITH ZONE AIR TEMP OF 0.00 DEG. F
 MAX ZONE AIR TEMP = 73.89 DEG. F AT HOUR 8

OZONE LOADS REPORT

DAYCARE CENTER

LOCATION: TULSA OKLAHOMA
 ZONE: 3 RECEPTION
 ENVIRONMENT TULSA OKLAHOMA SUMMER

DAYCARE CENTER
 1 DAYS

DATE	TIME	HEATING		COOLING		LATENT		RETURN AIR		BASEBOARD		ELECTRIC		GAS		INFILTRATION		TEMPERATURES	
		LOAD	1000BTU	LOAD	1000BTU	LOAD	1000BTU	HEAT GAIN	1000BTU	LOAD	1000BTU	LOAD	1000BTU	HEAT LOSS	1000BTU	HEAT GAIN	1000BTU	DB	WB
17	0.000E+00	1.592E+01	1.592E+00	1.680E+00	0.000E+00	0.000E+00	0.000E+00	0.000E+00	0.000E+00	0.000E+00	0.000E+00	0.000E+00	0.000E+00	0.000E+00	0.000E+00	0.000E+00	74.04	77.12	69.15
18	0.000E+00	3.013E+00	3.013E+00	5.100E-02	0.000E+00	0.000E+00	0.000E+00	0.000E+00	0.000E+00	0.000E+00	0.000E+00	0.000E+00	0.000E+00	0.000E+00	0.000E+00	0.000E+00	71.04	75.92	68.79
19	0.000E+00	1.891E+00	0.000E+00	0.000E+00	0.000E+00	0.000E+00	0.000E+00	0.000E+00	0.000E+00	0.000E+00	0.000E+00	0.000E+00	0.000E+00	0.000E+00	0.000E+00	0.000E+00	72.16	74.96	68.50
20	0.000E+00	0.000E+00	0.000E+00	0.000E+00	0.000E+00	0.000E+00	0.000E+00	0.000E+00	0.000E+00	0.000E+00	0.000E+00	0.000E+00	0.000E+00	0.000E+00	0.000E+00	0.000E+00	71.51	74.24	68.28
21	0.000E+00	0.000E+00	0.000E+00	0.000E+00	0.000E+00	0.000E+00	0.000E+00	0.000E+00	0.000E+00	0.000E+00	0.000E+00	0.000E+00	0.000E+00	0.000E+00	0.000E+00	0.000E+00	70.41	74.00	69.21
22	0.000E+00	0.000E+00	0.000E+00	0.000E+00	0.000E+00	0.000E+00	0.000E+00	0.000E+00	0.000E+00	0.000E+00	0.000E+00	0.000E+00	0.000E+00	0.000E+00	0.000E+00	0.000E+00	70.70	74.48	69.35
23	0.000E+00	0.000E+00	0.000E+00	0.000E+00	0.000E+00	0.000E+00	0.000E+00	0.000E+00	0.000E+00	0.000E+00	0.000E+00	0.000E+00	0.000E+00	0.000E+00	0.000E+00	0.000E+00	71.20	75.68	68.72
24	0.000E+00	1.272E+02	1.272E+02	1.864E+01	0.000E+00	0.000E+00	0.000E+00	0.000E+00	0.000E+00	0.000E+00	0.000E+00	0.000E+00	0.000E+00	0.000E+00	0.000E+00	0.000E+00	72.16	77.84	69.36
HEATING LOAD = 0.000E+00 1000BTU /FT**2 COOLING LOAD = 2.466E-01 1000BTU /FT**2 ZONE FLOOR AREA = 5.154E+02 FT**2 SPEAK LOADS AND TEMPERATURES:																			

MAX HEATING LOAD = 0.000E+00 1000BTU/HR AT HOUR 24 WITH ZONE AIR TEMP OF 75.12 DEG. F
 MAX COOLING LOAD = 1.811E+01 1000BTU/HR AT HOUR 16 WITH ZONE AIR TEMP OF 67.62 DEG. F
 MAX ZONE AIR TEMP = 80.52 DEG. F AT HOUR 20
 MIN ZONE AIR TEMP = 67.62 DEG. F AT HOUR 16

1 US ARMY CORPS OF ENGINEERS -- BLAST VERSION 3.0 (ANSI FORTRAN 77) LEVEL 215 28 AUG 95 12:34:24 PAGE 38

OZONE LOADS REPORT
 DAYCARE CENTER

LOCATION: TULSA OKLAHOMA
 OZONE: 4 MURPET ROOM
 ENVIRONMENT TULSA OKLAHOMA WINTER
 DAYCARE CENTER
 1 DAYS

DATE	HEATING	COOLING	LATENT	RETURN AIR	BASEBOARD	ELECTRIC	GAS	INFILT	INFILT	TEMPERATURES	
0 HR	LOAD	LOAD	LOAD	HEAT GAIN	LOAD	LOAD	LOAD	HEAT LOSS	HEAT GAIN	MAT. CHR	CHW
	1000BTU	1000BTU	1000BTU	1000BTU	1000BTU	1000BTU	1000BTU	1000BTU	1000BTU	DEG. F	DEG. F
1	2.158E+01	0.000E+00	0.000E+00	0.000E+00	0.000E+00	9.350E-02	0.000E+00	1.515E+01	0.000E+00	61.97	13.00
2	2.161E+01	0.000E+00	0.000E+00	0.000E+00	0.000E+00	9.350E-02	0.000E+00	1.515E+01	0.000E+00	61.94	13.00
3	2.165E+01	0.000E+00	0.000E+00	0.000E+00	0.000E+00	9.350E-02	0.000E+00	1.516E+01	0.000E+00	61.99	13.00
4	2.170E+01	0.000E+00	0.000E+00	0.000E+00	0.000E+00	9.350E-02	0.000E+00	1.516E+01	0.000E+00	62.00	13.00
5	2.173E+01	0.000E+00	0.000E+00	0.000E+00	0.000E+00	9.350E-02	0.000E+00	1.516E+01	0.000E+00	62.00	13.00
6	2.176E+01	0.000E+00	0.000E+00	0.000E+00	0.000E+00	9.350E-02	0.000E+00	1.517E+01	0.000E+00	62.01	13.00
7	2.094E+01	0.000E+00	4.250E-02	0.000E+00	0.000E+00	3.740E-01	0.000E+00	1.516E+01	0.000E+00	61.98	13.00
8	3.260E+01	0.000E+00	2.125E-01	0.000E+00	0.000E+00	1.870E+00	0.000E+00	1.829E+01	0.000E+00	72.11	13.00
9	1.982E+01	0.000E+00	4.917E+00	0.000E+00	0.000E+00	1.870E+00	0.000E+00	1.937E+01	0.000E+00	70.41	13.00
10	1.599E+01	0.000E+00	4.549E+00	0.000E+00	0.000E+00	1.870E+00	0.000E+00	1.890E+01	0.000E+00	69.83	13.00
11	1.437E+01	0.000E+00	4.423E+00	0.000E+00	0.000E+00	1.870E+00	0.000E+00	1.872E+01	0.000E+00	69.56	13.00
12	1.316E+01	0.000E+00	4.373E+00	0.000E+00	0.000E+00	1.870E+00	0.000E+00	1.864E+01	0.000E+00	69.43	13.00
13	1.675E+01	0.000E+00	4.135E+00	0.000E+00	0.000E+00	1.870E+00	0.000E+00	1.866E+01	0.000E+00	69.55	13.00
14	1.367E+01	0.000E+00	4.372E+00	0.000E+00	0.000E+00	1.870E+00	0.000E+00	1.864E+01	0.000E+00	69.44	13.00
15	1.325E+01	0.000E+00	4.349E+00	0.000E+00	0.000E+00	1.870E+00	0.000E+00	1.860E+01	0.000E+00	69.37	13.00
16	1.316E+01	0.000E+00	4.335E+00	0.000E+00	0.000E+00	1.870E+00	0.000E+00	1.859E+01	0.000E+00	69.35	13.00
17	1.642E+01	0.000E+00	4.119E+00	0.000E+00	0.000E+00	1.870E+00	0.000E+00	1.859E+01	0.000E+00	69.49	13.00
18	1.159E+01	0.000E+00	4.250E-02	0.000E+00	0.000E+00	9.350E-01	0.000E+00	1.559E+01	0.000E+00	60.23	13.00
19	1.741E+01	0.000E+00	0.000E+00	0.000E+00	0.000E+00	9.350E-02	0.000E+00	1.471E+01	0.000E+00	61.29	13.00
20	2.008E+01	0.000E+00	0.000E+00	0.000E+00	0.000E+00	9.350E-02	0.000E+00	1.498E+01	0.000E+00	61.71	13.00
21	2.088E+01	0.000E+00	0.000E+00	0.000E+00	0.000E+00	9.350E-02	0.000E+00	1.508E+01	0.000E+00	61.85	13.00
22	2.127E+01	0.000E+00	0.000E+00	0.000E+00	0.000E+00	9.350E-02	0.000E+00	1.512E+01	0.000E+00	61.92	13.00
23	2.143E+01	0.000E+00	0.000E+00	0.000E+00	0.000E+00	9.350E-02	0.000E+00	1.513E+01	0.000E+00	61.94	13.00
24	2.150E+01	0.000E+00	0.000E+00	0.000E+00	0.000E+00	9.350E-02	0.000E+00	1.514E+01	0.000E+00	61.96	13.00

OTOI 4.547E+02 0.000E+00 3.987E+01 0.000E+00 0.000E+00 2.113E+01 0.000E+00 3.989E+02 0.000E+00
 HEATING LOAD = 3.562E-01 1000BTU /FT**2 COOLING LOAD = 0.000E+00 1000BTU /FT**2 ZONE FLOOR AREA = 1.2.6E+03 FT**2
 PEAK LOADS AND TEMPERATURES:
 MAX HEATING LOAD = 3.260E+01 1000BTU/HR AT HOUR 8 WITH ZONE AIR TEMP OF 72.13 DEG. F
 MAX COOLING LOAD = 0.000E+00 1000BTU/HR AT HOUR 0 WITH ZONE AIR TEMP OF 0.00 DEG. F
 MAX ZONE AIR TEMP = 72.13 DEG. F AT HOUR 8
 MIN ZONE AIR TEMP = 60.23 DEG. F AT HOUR 18
 1 US ARMY CORPS OF ENGINEERS -- BLAST VERSION 3.0 (ANSI FORTRAN 77) LEVEL 215 28 AUG 95 12:34:24 PAGE 39

ZONE LOADS REPORT

DAYCARE CENTER

LOCATION: TULSA OKLAHOMA
 OZONE: 4 MUFFET ROOM
 ENVIRONMENT TULSA OKLAHOMA SUMMER

DAYCARE CENTER
1 DAYS

DATE 21 JUL (MONDAY)

0 HR	HEATING LOAD 1000BTU	COOLING LOAD 1000BTU	LATENT LOAD 1000BTU	RETURN AIR HEAT GAIN 1000BTU	BASEBOARD LOAD 1000BTU	ELECTRIC LOAD 1000BTU	GAS LOAD 1000BTU	INFILT HEAT LOSS 1000BTU	INFILT HEAT GAIN 1000BTU	TEMPERATURES			
										MAF	OUR	MAF	OUR
										DEG. F	DEG. F	DEG. F	DEG. F
1	0.000E+00	0.000E+00	0.000E+00	0.000E+00	0.000E+00	9.350E-02	0.000E+00	0.000E+00	0.000E+00	70.37	77.12	69.15	69.15
2	0.000E+00	0.000E+00	0.000E+00	0.000E+00	0.000E+00	9.350E-02	0.000E+00	0.000E+00	0.000E+00	69.60	75.92	68.79	68.79
3	0.000E+00	0.000E+00	0.000E+00	0.000E+00	0.000E+00	9.350E-02	0.000E+00	0.000E+00	0.000E+00	68.88	74.96	68.50	68.50
4	0.000E+00	0.000E+00	0.000E+00	0.000E+00	0.000E+00	9.350E-02	0.000E+00	0.000E+00	0.000E+00	63.36	74.24	68.28	68.28
5	0.000E+00	0.000E+00	0.000E+00	0.000E+00	0.000E+00	9.350E-02	0.000E+00	0.000E+00	0.000E+00	67.87	74.00	68.21	68.21
6	0.000E+00	0.000E+00	0.000E+00	0.000E+00	0.000E+00	9.350E-02	0.000E+00	0.000E+00	0.000E+00	67.66	74.48	68.35	68.35
7	0.000E+00	0.000E+00	4.250E-02	0.000E+00	0.000E+00	3.740E-01	0.000E+00	0.000E+00	0.000E+00	67.90	75.68	68.72	68.72
8	0.000E+00	0.000E+00	2.125E-01	0.000E+00	0.000E+00	1.870E+00	0.000E+00	0.000E+00	0.000E+00	71.44	77.04	69.16	69.16
9	0.000E+00	8.563E+00	4.769E+00	0.000E+00	0.000E+00	1.870E+00	0.000E+00	0.000E+00	0.000E+00	72.43	80.96	70.28	70.28
10	0.000E+00	1.166E+01	4.983E+00	0.000E+00	0.000E+00	1.870E+00	0.000E+00	0.000E+00	0.000E+00	71.73	84.56	71.32	71.32
11	0.000E+00	1.403E+01	4.829E+00	0.000E+00	0.000E+00	1.870E+00	0.000E+00	0.000E+00	0.000E+00	71.32	88.64	72.47	72.47
12	0.000E+00	1.565E+01	4.742E+00	0.000E+00	0.000E+00	1.870E+00	0.000E+00	0.000E+00	0.000E+00	71.12	92.48	73.52	73.52
13	0.000E+00	1.354E+01	4.488E+00	0.000E+00	0.000E+00	1.870E+00	0.000E+00	0.000E+00	0.000E+00	71.23	95.36	74.30	74.30
14	0.000E+00	1.721E+01	4.722E+00	0.000E+00	0.000E+00	1.870E+00	0.000E+00	0.000E+00	0.000E+00	70.91	97.28	74.81	74.81
15	0.000E+00	1.806E+01	4.676E+00	0.000E+00	0.000E+00	1.870E+00	0.000E+00	0.000E+00	0.000E+00	70.91	98.00	75.00	75.00
16	0.000E+00	1.826E+01	4.654E+00	0.000E+00	0.000E+00	1.870E+00	0.000E+00	0.000E+00	0.000E+00	70.92	97.28	74.81	74.81
17	0.000E+00	1.475E+01	4.424E+00	0.000E+00	0.000E+00	1.870E+00	0.000E+00	0.000E+00	0.000E+00	70.92	95.60	74.36	74.36
18	0.000E+00	0.000E+00	4.250E-02	0.000E+00	0.000E+00	9.350E-01	0.000E+00	0.000E+00	0.000E+00	75.97	92.96	73.65	73.65
19	0.000E+00	0.000E+00	0.000E+00	0.000E+00	0.000E+00	9.350E-02	0.000E+00	0.000E+00	0.000E+00	75.71	89.84	72.80	72.80
20	0.000E+00	0.000E+00	0.000E+00	0.000E+00	0.000E+00	9.350E-02	0.000E+00	0.000E+00	0.000E+00	73.82	96.72	71.93	71.93
21	0.000E+00	0.000E+00	0.000E+00	0.000E+00	0.000E+00	9.350E-02	0.000E+00	0.000E+00	0.000E+00	73.93	84.08	71.18	71.18

ZONE 15

DATE 21 JUL (MONDAY)	HEATING LOAD 1000BTU	COOLING LOAD 1000BTU	LATENT LOAD 1000BTU	RETURN AIR HEAT GAIN 1000BTU	BASEBOARD LOAD 1000BTU	ELECTRIC LOAD 1000BTU	GAS LOAD 1000BTU	INFILTRATION HEAT LOSS 1000BTU	INFILTRATION HEAT GAIN 1000BTU	TEMPERATURES MRT ODB OWB DEG. F DEG. F DEG. F
1	0.000E+00	0.000E+00	0.000E+00	0.000E+00	0.000E+00	1.020E-01	0.000E+00	0.000E+00	0.000E+00	71.67 77.12 69.15
2	0.000E+00	0.000E+00	0.000E+00	0.000E+00	0.000E+00	1.020E-01	0.000E+00	0.000E+00	0.000E+00	70.79 75.92 68.79
3	0.000E+00	0.000E+00	0.000E+00	0.000E+00	0.000E+00	1.020E-01	0.000E+00	0.000E+00	0.000E+00	69.98 74.96 68.50
4	0.000E+00	0.000E+00	0.000E+00	0.000E+00	0.000E+00	1.020E-01	0.000E+00	0.000E+00	0.000E+00	69.39 74.24 68.28
5	0.000E+00	0.000E+00	0.000E+00	0.000E+00	0.000E+00	1.020E-01	0.000E+00	0.000E+00	0.000E+00	68.88 74.00 68.21
6	0.000E+00	0.000E+00	0.000E+00	0.000E+00	0.000E+00	1.020E-01	0.000E+00	0.000E+00	0.000E+00	68.67 74.48 68.35
7	0.000E+00	0.000E+00	2.550E-02	0.000E+00	0.000E+00	4.040E-01	0.000E+00	0.000E+00	0.000E+00	65.77 75.68 68.72
8	0.000E+00	0.000E+00	1.275E-01	0.000E+00	0.000E+00	2.040E+00	0.000E+00	0.000E+00	0.000E+00	70.61 77.84 69.36
9	0.000E+00	5.684E+00	5.259E+00	0.000E+00	0.000E+00	2.040E+00	0.000E+00	2.548E+00	2.548E+00	72.64 80.96 70.28
10	0.000E+00	1.127E+01	5.779E+00	0.000E+00	0.000E+00	2.040E+00	0.000E+00	3.849E+00	3.849E+00	72.21 84.56 71.32
11	0.000E+00	1.446E+01	5.668E+00	0.000E+00	0.000E+00	2.040E+00	0.000E+00	5.531E+00	5.531E+00	71.92 88.64 72.47
12	0.000E+00	1.734E+01	5.590E+00	0.000E+00	0.000E+00	2.040E+00	0.000E+00	7.208E+00	7.208E+00	71.71 92.48 73.52
13	0.000E+00	1.770E+01	5.423E+00	0.000E+00	0.000E+00	2.040E+00	0.000E+00	8.526E+00	8.526E+00	71.70 95.36 74.30
14	0.000E+00	2.121E+01	5.533E+00	0.000E+00	0.000E+00	2.040E+00	0.000E+00	9.480E+00	9.480E+00	71.55 97.28 74.81
15	0.000E+00	2.281E+01	5.493E+00	0.000E+00	0.000E+00	2.040E+00	0.000E+00	9.909E+00	9.909E+00	71.36 98.00 75.00
16	0.000E+00	2.406E+01	5.446E+00	0.000E+00	0.000E+00	2.040E+00	0.000E+00	9.681E+00	9.681E+00	71.11 97.28 74.81
17	0.000E+00	2.272E+01	5.755E+00	0.000E+00	0.000E+00	2.040E+00	0.000E+00	8.941E+00	8.941E+00	71.06 95.60 74.36
18	0.000E+00	0.000E+00	2.550E-02	0.000E+00	0.000E+00	1.020E+00	0.000E+00	0.000E+00	0.000E+00	77.30 92.95 73.65
19	0.000E+00	0.000E+00	0.000E+00	0.000E+00	0.000E+00	1.020E-01	0.000E+00	0.000E+00	0.000E+00	77.70 89.84 72.80
20	0.000E+00	0.000E+00	0.000E+00	0.000E+00	0.000E+00	1.020E-01	0.000E+00	0.000E+00	0.000E+00	75.70 86.72 71.93
21	0.000E+00	0.000E+00	0.000E+00	0.000E+00	0.000E+00	1.020E-01	0.000E+00	0.000E+00	0.000E+00	75.71 84.08 71.18
22	0.000E+00	0.000E+00	0.000E+00	0.000E+00	0.000E+00	1.020E-01	0.000E+00	0.000E+00	0.000E+00	74.63 81.68 70.49
23	0.000E+00	0.000E+00	0.000E+00	0.000E+00	0.000E+00	1.020E-01	0.000E+00	0.000E+00	0.000E+00	73.53 79.76 69.93
24	0.000E+00	0.000E+00	0.000E+00	0.000E+00	0.000E+00	1.020E-01	0.000E+00	0.000E+00	0.000E+00	72.58 78.32 69.50
OTOT	0.000E+00	1.570E+02	4.962E+01	0.000E+00	2.305E+01	2.305E+01	0.000E+00	0.000E+00	6.567E+01	
OHEATING LOAD = 0.000E+00 1000BTU /FT**2 COOLING LOAD = 8.580E-02 1000BTU /FT**2 ZONE FLOOR AREA = 1.829E+03 FT**2										
OPEAK LOADS AND TEMPERATURES:										
MAX HEATING LOAD = 0.000E+00 1000BTU/HR AT HOUR 24 WITH ZONE AIR TEMP OF 72.58 DEG. F										
MAX COOLING LOAD = 2.406E+01 1000BTU/HR AT HOUR 16 WITH ZONE AIR TEMP OF 71.11 DEG. F										
MAX ZONE AIR TEMP = 77.70 DEG. F AT HOUR 19										
MIN ZONE AIR TEMP = 68.67 DEG. F AT HOUR 6										

OZONE LOADS REPORT

DAYCARE CENTER

22 0.000E+00 0.000E+00 0.000E+00 0.000E+00 0.000E+00 9.350E-02 0.000E+00 0.000E+00 0.000E+00 0.000E+00 72.92 81.68 70.49
 23 0.000E+00 0.000E+00 0.000E+00 0.000E+00 0.000E+00 9.350E-02 0.000E+00 0.000E+00 0.000E+00 0.000E+00 71.97 79.76 69.93
 24 0.000E+00 0.000E+00 0.000E+00 0.000E+00 0.000E+00 9.350E-02 0.000E+00 0.000E+00 0.000E+00 0.000E+00 71.16 78.32 69.50
 OTOT 0.000E+00 1.317E+02 4.259E+01 0.000E+00 0.000E+00 2.113E+01 0.000E+00 0.000E+00 0.000E+00 3.369E+01
 HEATING LOAD = 0.000E+00 1000BTU /FT**2 COOLING LOAD = 1.032E-01 1000BTU /FT**2 ZONE FLOOR AREA = 1.276E+03 FT**2
 PEAK LOADS AND TEMPERATURES:

MAX HEATING LOAD = 0.000E+00 1000BTU/HR AT HOUR 24 WITH ZONE AIR TEMP OF 71.16 DEG. F
 MAX COOLING LOAD = 1.826E+01 1000BTU/HR AT HOUR 16 WITH ZONE AIR TEMP OF 70.82 DEG. F
 MIN ZONE AIR TEMP = 75.97 DEG. F AT HOUR 18
 MIN ZONE AIR TEMP = 67.66 DEG. F AT HOUR 6
 1 US ARMY CORPS OF ENGINEERS -- BLAST VERSION 3.0 (ANSI FORTRAN 77) LEVEL 215 28 AUG 95 12:34:24 PAGE 40

OZONE LOADS REPORT
 DAYCARE CENTER

LOCATION: TULSA OKLAHOMA
 OZONE: 5 SHORT TALKS ROOM
 ENVIRONMENT TULSA OKLAHOMA WINTER

DAYCARE CENTER
 1 DAYS

DATE 21 JAN (MONDAY)	HEATING			COOLING			LATENT			RETURN AIR			BASEBOARD			ELECTRIC			GAS			INFILTRATION			TEMPERATURES				
	LOAD	1000BTU	1000BTU	LOAD	1000BTU	1000BTU	LOAD	1000BTU	1000BTU	HEAT GAIN	1000BTU	HEAT LOSS	1000BTU	LOAD	1000BTU	LOAD	1000BTU	LOAD	1000BTU	LOAD	1000BTU	HEAT GAIN	1000BTU	HEAT LOSS	1000BTU	DEG. F	COB	DEG. F	OMB
1	4.049E+01	0.000E+00	0.000E+00	0.000E+00	0.000E+00	0.000E+00	0.000E+00	0.000E+00	0.000E+00	0.000E+00	0.000E+00	0.000E+00	0.000E+00	0.000E+00	0.000E+00	0.000E+00	0.000E+00	0.000E+00	0.000E+00	0.000E+00	0.000E+00	0.000E+00	0.000E+00	0.000E+00	61.87	13.00	13.00	13.00	13.00
2	4.053E+01	0.000E+00	0.000E+00	0.000E+00	0.000E+00	0.000E+00	0.000E+00	0.000E+00	0.000E+00	0.000E+00	0.000E+00	0.000E+00	0.000E+00	0.000E+00	0.000E+00	0.000E+00	0.000E+00	0.000E+00	0.000E+00	0.000E+00	0.000E+00	0.000E+00	0.000E+00	0.000E+00	61.87	13.00	13.00	13.00	13.00
3	4.058E+01	0.000E+00	0.000E+00	0.000E+00	0.000E+00	0.000E+00	0.000E+00	0.000E+00	0.000E+00	0.000E+00	0.000E+00	0.000E+00	0.000E+00	0.000E+00	0.000E+00	0.000E+00	0.000E+00	0.000E+00	0.000E+00	0.000E+00	0.000E+00	0.000E+00	0.000E+00	0.000E+00	61.84	13.00	13.00	13.00	13.00
4	4.063E+01	0.000E+00	0.000E+00	0.000E+00	0.000E+00	0.000E+00	0.000E+00	0.000E+00	0.000E+00	0.000E+00	0.000E+00	0.000E+00	0.000E+00	0.000E+00	0.000E+00	0.000E+00	0.000E+00	0.000E+00	0.000E+00	0.000E+00	0.000E+00	0.000E+00	0.000E+00	0.000E+00	61.85	13.00	13.00	13.00	13.00
5	4.067E+01	0.000E+00	0.000E+00	0.000E+00	0.000E+00	0.000E+00	0.000E+00	0.000E+00	0.000E+00	0.000E+00	0.000E+00	0.000E+00	0.000E+00	0.000E+00	0.000E+00	0.000E+00	0.000E+00	0.000E+00	0.000E+00	0.000E+00	0.000E+00	0.000E+00	0.000E+00	0.000E+00	61.85	13.00	13.00	13.00	13.00
6	4.070E+01	0.000E+00	0.000E+00	0.000E+00	0.000E+00	0.000E+00	0.000E+00	0.000E+00	0.000E+00	0.000E+00	0.000E+00	0.000E+00	0.000E+00	0.000E+00	0.000E+00	0.000E+00	0.000E+00	0.000E+00	0.000E+00	0.000E+00	0.000E+00	0.000E+00	0.000E+00	0.000E+00	61.85	13.00	13.00	13.00	13.00
7	4.072E+01	0.000E+00	0.000E+00	0.000E+00	0.000E+00	0.000E+00	0.000E+00	0.000E+00	0.000E+00	0.000E+00	0.000E+00	0.000E+00	0.000E+00	0.000E+00	0.000E+00	0.000E+00	0.000E+00	0.000E+00	0.000E+00	0.000E+00	0.000E+00	0.000E+00	0.000E+00	0.000E+00	61.85	13.00	13.00	13.00	13.00
8	4.073E+01	0.000E+00	0.000E+00	0.000E+00	0.000E+00	0.000E+00	0.000E+00	0.000E+00	0.000E+00	0.000E+00	0.000E+00	0.000E+00	0.000E+00	0.000E+00	0.000E+00	0.000E+00	0.000E+00	0.000E+00	0.000E+00	0.000E+00	0.000E+00	0.000E+00	0.000E+00	0.000E+00	61.84	13.00	13.00	13.00	13.00
9	4.073E+01	0.000E+00	0.000E+00	0.000E+00	0.000E+00	0.000E+00	0.000E+00	0.000E+00	0.000E+00	0.000E+00	0.000E+00	0.000E+00	0.000E+00	0.000E+00	0.000E+00	0.000E+00	0.000E+00	0.000E+00	0.000E+00	0.000E+00	0.000E+00	0.000E+00	0.000E+00	0.000E+00	72.01	13.00	13.00	13.00	13.00
10	4.073E+01	0.000E+00	0.000E+00	0.000E+00	0.000E+00	0.000E+00	0.000E+00	0.000E+00	0.000E+00	0.000E+00	0.000E+00	0.000E+00	0.000E+00	0.000E+00	0.000E+00	0.000E+00	0.000E+00	0.000E+00	0.000E+00	0.000E+00	0.000E+00	0.000E+00	0.000E+00	0.000E+00	70.52	13.00	13.00	13.00	13.00
11	4.064E+01	0.000E+00	0.000E+00	0.000E+00	0.000E+00	0.000E+00	0.000E+00	0.000E+00	0.000E+00	0.000E+00	0.000E+00	0.000E+00	0.000E+00	0.000E+00	0.000E+00	0.000E+00	0.000E+00	0.000E+00	0.000E+00	0.000E+00	0.000E+00	0.000E+00	0.000E+00	0.000E+00	70.00	13.00	13.00	13.00	13.00
12	3.960E+01	0.000E+00	0.000E+00	0.000E+00	0.000E+00	0.000E+00	0.000E+00	0.000E+00	0.000E+00	0.000E+00	0.000E+00	0.000E+00	0.000E+00	0.000E+00	0.000E+00	0.000E+00	0.000E+00	0.000E+00	0.000E+00	0.000E+00	0.000E+00	0.000E+00	0.000E+00	0.000E+00	69.33	13.00	13.00	13.00	13.00
13	4.137E+01	0.000E+00	0.000E+00	0.000E+00	0.000E+00	0.000E+00	0.000E+00	0.000E+00	0.000E+00	0.000E+00	0.000E+00	0.000E+00	0.000E+00	0.000E+00	0.000E+00	0.000E+00	0.000E+00	0.000E+00	0.000E+00	0.000E+00	0.000E+00	0.000E+00	0.000E+00	0.000E+00	69.71	13.00	13.00	13.00	13.00
14	3.947E+01	0.000E+00	0.000E+00	0.000E+00	0.000E+00	0.000E+00	0.000E+00	0.000E+00	0.000E+00	0.000E+00	0.000E+00	0.000E+00	0.000E+00	0.000E+00	0.000E+00	0.000E+00	0.000E+00	0.000E+00	0.000E+00	0.000E+00	0.000E+00	0.000E+00	0.000E+00	0.000E+00	69.71	13.00	13.00	13.00	13.00
15	3.916E+01	0.000E+00	0.000E+00	0.000E+00	0.000E+00	0.000E+00	0.000E+00	0.000E+00	0.000E+00	0.000E+00	0.000E+00	0.000E+00	0.000E+00	0.000E+00	0.000E+00	0.000E+00	0.000E+00	0.000E+00	0.000E+00	0.000E+00	0.000E+00	0.000E+00	0.000E+00	0.000E+00	69.69	13.00	13.00	13.00	13.00
16	3.908E+01	0.000E+00	0.000E+00	0.000E+00	0.000E+00	0.000E+00	0.000E+00	0.000E+00	0.000E+00	0.000E+00	0.000E+00	0.000E+00	0.000E+00	0.000E+00	0.000E+00	0.000E+00	0.000E+00	0.000E+00	0.000E+00	0.000E+00	0.000E+00	0.000E+00	0.000E+00	0.000E+00	69.65	13.00	13.00	13.00	13.00
17	4.101E+01	0.000E+00	0.000E+00	0.000E+00	0.000E+00	0.000E+00	0.000E+00	0.000E+00	0.000E+00	0.000E+00	0.000E+00	0.000E+00	0.000E+00	0.000E+00	0.000E+00	0.000E+00	0.000E+00	0.000E+00	0.000E+00	0.000E+00	0.000E+00	0.000E+00	0.000E+00	0.000E+00	69.66	13.00	13.00	13.00	13.00
18	2.531E+01	0.000E+00	0.000E+00	0.000E+00	0.000E+00	0.000E+00	0.000E+00	0.000E+00	0.000E+00	0.000E+00	0.000E+00	0.000E+00	0.000E+00	0.000E+00	0.000E+00	0.000E+00	0.000E+00	0.000E+00	0.000E+00	0.000E+00	0.000E+00	0.000E+00	0.000E+00	0.000E+00	69.70	13.00	13.00	13.00	13.00

19	3.391E+01	0.000E+00	0.000E+00	0.000E+00	0.000E+00	0.000E+00	1.020E-01	0.000E+00	2.937E+01	0.000E+00	61.21	13.00	13.00
20	3.825E+01	0.000E+00	0.000E+00	0.000E+00	0.000E+00	0.000E+00	1.020E-01	0.000E+00	2.988E+01	0.000E+00	61.67	13.00	13.00
21	3.959E+01	0.000E+00	0.000E+00	0.000E+00	0.000E+00	0.000E+00	1.020E-01	0.000E+00	3.006E+01	0.000E+00	61.74	13.00	13.00
22	4.016E+01	0.000E+00	0.000E+00	0.000E+00	0.000E+00	0.000E+00	1.020E-01	0.000E+00	3.013E+01	0.000E+00	61.77	13.00	13.00
23	4.034E+01	0.000E+00	0.000E+00	0.000E+00	0.000E+00	0.000E+00	1.020E-01	0.000E+00	3.015E+01	0.000E+00	61.81	13.00	13.00
24	4.042E+01	0.000E+00	0.000E+00	0.000E+00	0.000E+00	0.000E+00	1.020E-01	0.000E+00	3.015E+01	0.000E+00	61.82	13.00	13.00

OTOT 9.780E+02 0.000E+00 4.606E+01 0.000E+00 2.305E+01 0.000E+00 7.982E+02 0.000E+00
 HEATING LOAD = 5.346E-01 1000BTU /FT**2 COOLING LOAD = 0.000E+00 1000BTU /FT**2 ZONE FLOOR AREA = 1.829E+03 FT**2
 OPEAK LOADS AND TEMPERATURES:

MAX HEATING LOAD = 6.438E+01 1000BTU/HR AT HOUR 8 WITH ZONE AIR TEMP OF 72.01 DEG. F
 MAX COOLING LOAD = 0.000E+00 1000BTU/HR AT HOUR 0 WITH ZONE AIR TEMP OF 0.00 DEG. F
 MIN ZONE AIR TEMP = 72.01 DEG. F AT HOUR 8
 MIN ZONE AIR TEMP = 60.20 DEG. F AT HOUR 18

1 US ARMY CORPS OF ENGINEERS -- BLAST VERSION 3.0 (ANSI FORTRAN 77) LEVEL 215 28 AUG 95 12:14:24 PAGE 41

OZONE LOADS REPORT

DAYCARE CENTER

LOCATION: TULSA OKLAHOMA
 OZONE: 5 SHORT TALES ROOM
 ENVIRONMENT TULSA OKLAHOMA SUMMER

DAYCARE CENTER
 1 DAYS

DATE 21 JUL (MONDAY)	0 HR HEATING LOAD 1000BTU	COOLING LOAD 1000BTU	LATENT LOAD 1000BTU	RETURN AIR HEAT GAIN 1000BTU	BASEBOARD LOAD 1000BTU	ELECTRIC LOAD 1000BTU	GAS LOAD 1000BTU	INFILT HEAT LOSS 1000BTU	INFILT HEAT GAIN 1000BTU	M.T. DEG. F	ODB DEG. F	OMB DEG. F
1	0.000E+00	0.000E+00	0.000E+00	0.000E+00	0.000E+00	1.020E-01	0.000E+00	0.000E+00	0.000E+00	71.67	77.12	69.15
2	0.000E+00	0.000E+00	0.000E+00	0.000E+00	0.000E+00	1.020E-01	0.000E+00	0.000E+00	0.000E+00	77.77	75.92	68.79
3	0.000E+00	0.000E+00	0.000E+00	0.000E+00	0.000E+00	1.020E-01	0.000E+00	0.000E+00	0.000E+00	69.58	74.96	68.50
4	0.000E+00	0.000E+00	0.000E+00	0.000E+00	0.000E+00	1.020E-01	0.000E+00	0.000E+00	0.000E+00	69.37	74.24	68.28
5	0.000E+00	0.000E+00	0.000E+00	0.000E+00	0.000E+00	1.020E-01	0.000E+00	0.000E+00	0.000E+00	68.98	74.00	68.21
6	0.000E+00	0.000E+00	0.000E+00	0.000E+00	0.000E+00	1.020E-01	0.000E+00	0.000E+00	0.000E+00	68.67	74.48	68.35
7	0.000E+00	0.000E+00	2.550E-02	0.000E+00	0.000E+00	4.080E-01	0.000E+00	0.000E+00	0.000E+00	68.77	75.68	68.72
8	0.000E+00	0.000E+00	1.275E-01	0.000E+00	0.000E+00	2.040E+00	0.000E+00	0.000E+00	0.000E+00	70.61	77.84	69.36
9	0.000E+00	5.684E+00	5.259E+00	0.000E+00	0.000E+00	2.040E+00	0.000E+00	0.000E+00	0.000E+00	72.64	80.96	70.28
10	0.000E+00	1.127E+01	5.779E+00	0.000E+00	0.000E+00	2.040E+00	0.000E+00	0.000E+00	0.000E+00	72.21	84.56	71.32
11	0.000E+00	1.446E+01	5.568E+00	0.000E+00	0.000E+00	2.040E+00	0.000E+00	0.000E+00	0.000E+00	71.92	88.64	72.47
12	0.000E+00	1.734E+01	5.580E+00	0.000E+00	0.000E+00	2.040E+00	0.000E+00	0.000E+00	0.000E+00	71.7	92.48	73.52
13	0.000E+00	1.770E+01	5.423E+00	0.000E+00	0.000E+00	2.040E+00	0.000E+00	0.000E+00	0.000E+00	71.5	95.36	74.30
14	0.000E+00	2.121E+01	5.533E+00	0.000E+00	0.000E+00	2.040E+00	0.000E+00	0.000E+00	0.000E+00	71.53	97.28	74.81
15	0.000E+00	2.281E+01	5.493E+00	0.000E+00	0.000E+00	2.040E+00	0.000E+00	0.000E+00	0.000E+00	71.3	98.00	75.00

APPENDIX E.4

PSYCHROMETRIC CHARTS USED IN THE SELECTION OF THE DAYCARE CENTER HEAT PUMPS

ASHRAE PSYCHROMETRIC CHART NO. 1



NORMAL TEMPERATURE

BAROMETRIC PRESSURE, 29.921 INCHES OF MERCURY

COPYRIGHT 1992

AMERICAN SOCIETY OF HEATING, REFRIGERATING AND AIR CONDITIONING ENGINEERS, INC.

ZONE 3

SEA LEVEL

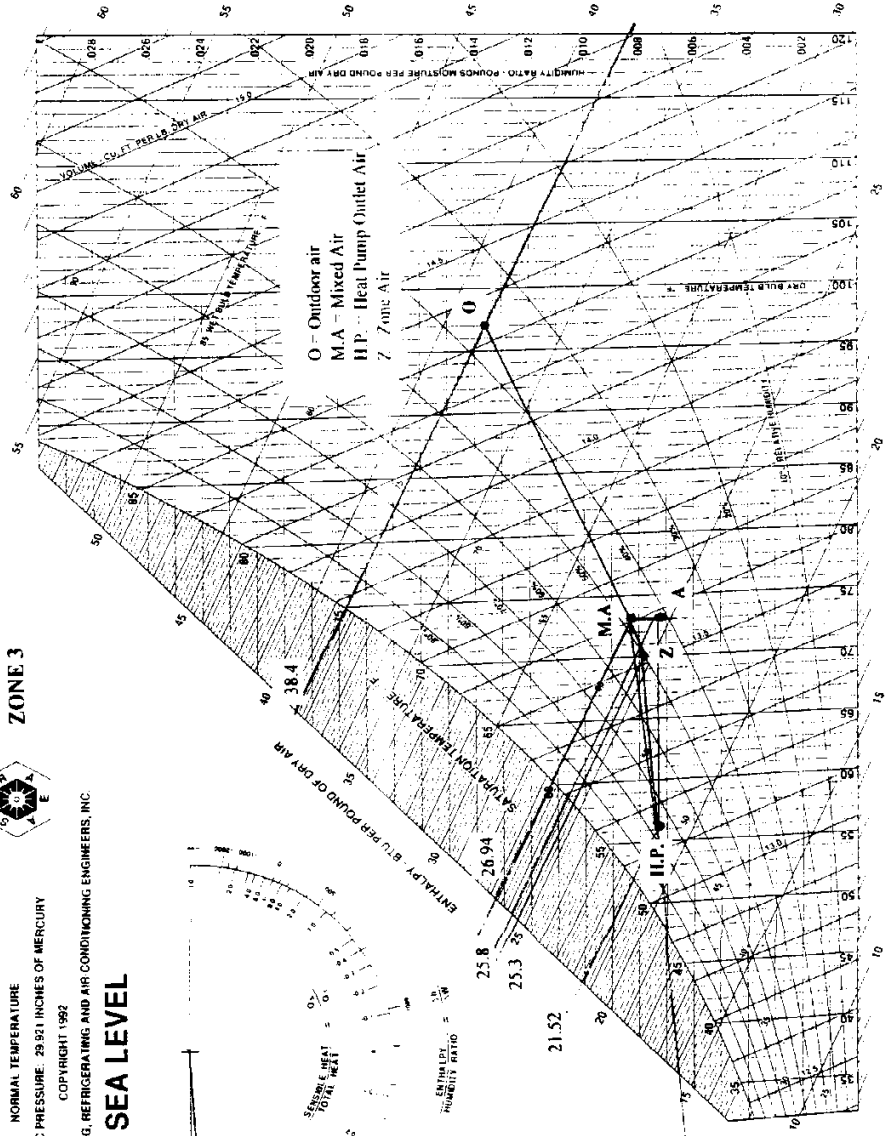
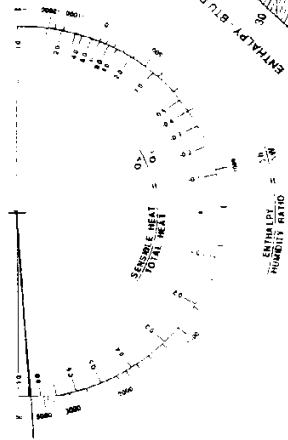

Copyright © 1992 by ASHRAE, Inc. All rights reserved.

ASHRAE PSYCHROMETRIC CHART NO. 1
NORMAL TEMPERATURE
BAROMETRIC PRESSURE: 29.921 INCHES OF MERCURY



ZONE 5

AMERICAN SOCIETY OF HEATING, REFRIGERATING AND AIR CONDITIONING ENGINEERS, INC.
COPYRIGHT 1982

SEA LEVEL

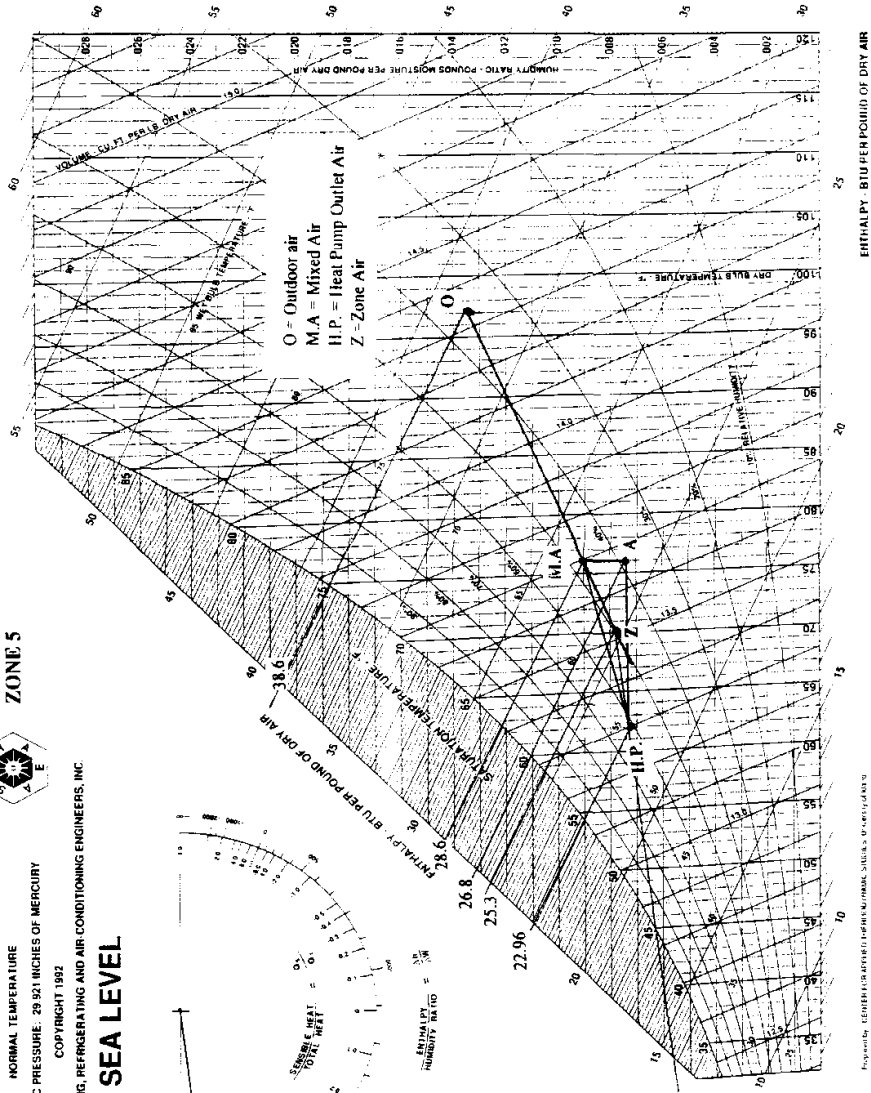
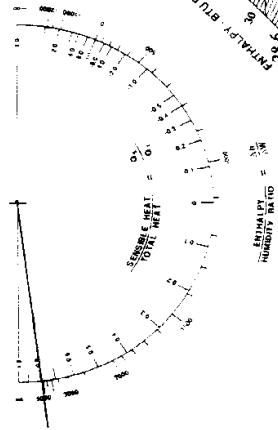

Property: ASHRAE Psychrometric Chart, 1982, ASHRAE, Inc.

APPENDIX E.5

BLAST OUTPUT FILE OF THE DAYCARE CENTER, USING THE ORIGINAL
CODE.

0 REPORTING WILL BE DONE IN UNITS ENGLISH
0 SIMULATIONS WILL BE ALLOWED FOR TYPES% ZONES SYSTEMS PLANTS

1 BUILDING SIMULATIONS WILL BE ATTEMPTED

SIMULATIONS WILL BE ATTEMPTED FOR 6 ZONES

SIMULATIONS WILL BE ATTEMPTED FOR 1 SYSTEMS

SIMULATIONS WILL BE ATTEMPTED FOR 0 PLANTS

0 NEW BLDLFL AND AHLDFL FILES WILL BE CREATED
FROM USER INPUT, AS NECESSARY

0 LOCATION TAKEN FROM ATTACHED WTHRFL
TITLE= OKLAHOMA CITY/WILL RODGERS, OK LAT= 35.400 LONG= 97.600 TIME ZONE= 6.0

0 * * * * *
BLDFL FOR
DAYCARE CENTER

LOCATION OKLAHOMA CITY/WILL RODGERS, OK LAT= 35.400 LONG= 97.600 TIME ZONE= 6.0
DATE OF FILE CREATE/UPDATE 5 SEP 95 NUMBER OF ENVIRONMENTS 1
NUMBER OF ZONES 6 WITH ZONE NUMBERS
1 2 3 4 5 6

0 * * * * *
AHLDFL FOR
DAYCARE CENTER

LOCATION OKLAHOMA CITY/WILL RODGERS, OK LAT= 35.400 LONG= 97.600 TIME ZONE= 6.0
DATE OF FILE CREATE/UPDATE 5 SEP 95 NUMBER OF ENVIRONMENTS 1
NUMBER OF SYSTEMS 1 WITH SYSTEM NUMBERS
1

***** SIMULATION PERIOD 1 JAN 1979 THRU 31 DEC 1979

0 ENVIRONMENT NUMBER 1 FOR BLDLFL TITLE IS OKLAHOMA CITY/WILL RODGERS, OK
WEATHER STATION 13967 START DATE OF 1 JAN 1979 NO. OF DAYS 365
WITH GROUND TEMPERATURES JAN =55.00 FEB =55.00 MAR =55.00 APR =55.00 MAY =55.00 JUN =55.00
JUL =55.00 AUG =55.00 SEP =55.00 OCT =55.00 NOV =55.00 DEC =55.00
WITH MAKE UP WATER TEMPERATURES JAN =55.00 FEB =55.00 MAR =55.00 APR =55.00 MAY =55.00 JUN =55.00
JUL =55.00 AUG =55.00 SEP =55.00 OCT =55.00 NOV =55.00 DEC =55.00
0 ENVIRONMENT NUMBER 1 FOR AHLDFL TITLE IS OKLAHOMA CITY/WILL RODGERS, OK
WEATHER STATION 13967 START DATE OF 1 JAN 1979 NO. OF DAYS 365
WITH GROUND TEMPERATURES JAN =55.00 FEB =55.00 MAR =55.00 APR =55.00 MAY =55.00 JUN =55.00
JUL =55.00 AUG =55.00 SEP =55.00 OCT =55.00 NOV =55.00 DEC =55.00
WITH MAKE UP WATER TEMPERATURES JAN =55.00 FEB =55.00 MAR =55.00 APR =55.00 MAY =55.00 JUN =55.00
JUL =55.00 AUG =55.00 SEP =55.00 OCT =55.00 NOV =55.00 DEC =55.00

ZONE GROUP LOADS FOR OKLAHOMA CITY/WILL RODGERS, OK

SIMULATION PERIOD 1 JAN 1979 THRU 31 DEC 1979

NUMBER NAME MULTIPLIER

1	1	MECHANICAL ROOM	1
2	2	SMURF ROOM	1
3	3	RECEPTION	1
4	4	MUPPET ROOM	1
5	5	SHORT TALES ROOM	1
6	6	ATTIC	1

ZONE	TOTAL CONVECTIVE HEATER LOAD	TOTAL RADIANT HEATER LOAD	TOTAL SENSIBLE COOLING LOAD	PEAK CONVECTIVE HEATER LOAD	PEAK RADIANT HEATER LOAD	PEAK SENSIBLE COOLING LOAD	MAX TEMP DEG. F	MIN TEMP DEG. F
	1000BTU	1000BTU	1000BTU	1000BTU/HR	1000BTU/HR	1000BTU/HR		
1	0.000E+00	0.000E+00	0.000E+00	0.000E+00	0.000E+00	0.000E+00	142.69	22.20
2	2.803E+04	0.000E+00	1.681E+04	3.821E+01	0.000E+00	2.598E+01	81.36	59.21
3	2.014E+04	0.000E+00	1.461E+04	2.583E+01	0.000E+00	2.118E+01	80.89	59.77
4	2.728E+04	0.000E+00	1.480E+04	3.677E+01	0.000E+00	2.238E+01	78.26	59.49
5	5.673E+04	0.000E+00	1.305E+04	7.270E+01	0.000E+00	3.114E+01	81.07	59.79
6	0.000E+00	0.000E+00	0.000E+00	0.000E+00	0.000E+00	0.000E+00	104.01	10.40
OGROUP:	1.322E+05	0.000E+00	5.927E+04	1.732E+02	0.000E+00	1.007E+02	142.69	10.40
OPeak DATES (MO/DY/HR):				1/ 4/ 8	1/ 1/ 1	9/14/15	7/18/16	1/15/ 8

OTOTAL ITERATIONS = 34370
DID NOT CONVERGE = 58

1 US ARMY CORPS OF ENGINEERS -- BLAST VERSION 3.0 (ANSI FORTRAN 77) LEVEL 215 5 SEP 95 22: 7: 9 PAGE 31

```

*****
**
**           A I R   H A N D L I N G   S Y S T E M   E N E R G Y   U S E   S U M M A R Y
**
*****

```

SYSTEM NUMBER= 1, WATER LOOP SYSTEM
SYSTEM LOCATION = 13967 OKLAHOMA CITY/WILL RODGERS, OK SIMULATION PERIOD 1JAN1979 - 31DEC1979

0	MONTH	BUILDING ELECTRIC		SYSTEM EQUIPMENT		ELECTRIC HEATING		TOTAL USE	
		CONSUMPTION (BTU)	PEAK DEMAND (BTU/HR)	CONSUMPTION (BTU)	PEAK DEMAND (BTU/HR)	CONSUMPTION (BTU)	PEAK DEMAND (BTU/HR)	CONSUMPTION (BTU)	PEAK DEMAND (BTU/HR)
0	JAN	1.676E+06	6.460E+03	3.815E+05	1.927E+03	0.000E+00	0.000E+00	1.334E+07	6.383E+04
0	FEB	1.457E+06	6.460E+03	3.295E+05	1.927E+03	0.000E+00	0.000E+00	1.040E+07	5.846E+04
0	MAR	1.676E+06	6.460E+03	3.815E+05	1.927E+03	0.000E+00	0.000E+00	8.941E+06	5.278E+04
0	APR	1.603E+06	6.460E+03	3.642E+05	1.927E+03	0.000E+00	0.000E+00	5.572E+06	4.796E+04
0	MAY	1.676E+06	6.460E+03	3.815E+05	1.927E+03	0.000E+00	0.000E+00	6.194E+06	5.747E+04
0	JUN	1.603E+06	6.460E+03	3.642E+05	1.927E+03	0.000E+00	0.000E+00	8.924E+06	7.318E+04
0	JUL	1.610E+06	6.460E+03	3.642E+05	1.927E+03	0.000E+00	0.000E+00	9.544E+06	7.107E+04
0	AUG	1.741E+06	6.460E+03	3.988E+05	1.927E+03	0.000E+00	0.000E+00	1.044E+07	6.778E+04
0	SEP	1.472E+06	6.460E+03	3.295E+05	1.927E+03	0.000E+00	0.000E+00	7.226E+06	6.974E+04
0	OCT	1.676E+06	6.460E+03	3.815E+05	1.927E+03	0.000E+00	0.000E+00	5.947E+06	4.969E+04
0	NOV	1.537E+06	6.460E+03	3.468E+05	1.927E+03	0.000E+00	0.000E+00	7.072E+06	3.567E+04
0	DEC	1.545E+06	6.460E+03	3.468E+05	1.927E+03	0.000E+00	0.000E+00	1.076E+07	5.441E+04
0	TOT	1.927E+07	6.460E+03	4.370E+06	1.927E+03	0.000E+00	0.000E+00	1.044E+08	7.318E+04

SYSTEM NUMBER= 1, WATER LOOP SYSTEM
 SYSTEM LOCATION = 13967 OKLAHOMA CITY/WILL RODGERS, OK SIMULATION PERIOD 1JAN1979 - 31DEC1979

MONTH	ZONE 2		ZONE 3		ZONE 4		ZONE 5		PUMP5		OUTLET TEMP.	
	PUMP1		PUMP2		PUMP3		PUMP4				MAX	MIN
	CONSUMPTION/PEAK	CONSUMPTION/PEAK	CONSUMPTION/PEAK	CONSUMPTION/PEAK	CONSUMPTION/PEAK	CONSUMPTION/PEAK	CONSUMPTION/PEAK	CONSUMPTION/PEAK	CONSUMPTION/PEAK	CONSUMPTION/PEAK	DEG. F	
	1000BTU	1000BTU/H	1000BTU	1000BTU/H	1000BTU	1000BTU/H	1000BTU	1000BTU/H	1000BTU	1000BTU/H		
JAN	2.73E+03	1.43E+01	1.48E+03	6.64E+00	2.62E+03	1.36E+01	4.22E+03	1.97E+01	0.00E+00	0.00E+00	82.53	62.59
FEB	2.08E+03	1.28E+01	1.10E+03	5.71E+00	2.02E+03	1.22E+01	3.23E+03	1.83E+01	0.00E+00	0.00E+00	82.35	62.60
MAR	1.67E+03	1.10E+01	9.24E+02	5.31E+00	1.61E+03	1.05E+01	2.53E+03	1.67E+01	0.00E+00	0.00E+00	82.99	62.62
APR	1.02E+03	1.25E+01	5.96E+02	5.94E+00	9.39E+02	1.12E+01	9.85E+02	9.33E+00	0.00E+00	0.00E+00	83.04	62.62
MAY	1.26E+03	1.49E+01	6.83E+02	6.90E+00	1.14E+03	1.38E+01	9.79E+02	1.27E+01	0.00E+00	0.00E+00	83.19	62.67
JUN	2.14E+03	1.96E+01	1.05E+03	8.50E+00	1.97E+03	1.83E+01	1.68E+03	1.73E+01	0.00E+00	0.00E+00	83.22	62.73
JUL	2.33E+03	1.93E+01	1.16E+03	8.18E+00	2.13E+03	1.77E+01	1.83E+03	1.65E+01	0.00E+00	0.00E+00	83.21	62.66
AUG	2.56E+03	1.79E+01	1.28E+03	8.02E+00	2.34E+03	1.67E+01	1.98E+03	1.58E+01	0.00E+00	0.00E+00	83.21	63.42
SEP	1.66E+03	1.86E+01	8.57E+02	8.50E+00	1.52E+03	1.67E+01	1.29E+03	1.65E+01	0.00E+00	0.00E+00	83.18	62.72
OCT	1.11E+03	1.32E+01	6.89E+02	6.74E+00	1.01E+03	1.16E+01	1.01E+03	9.61E+00	0.00E+00	0.00E+00	83.15	62.65
NOV	1.25E+03	6.66E+00	7.48E+02	5.29E+00	1.22E+03	6.57E+00	1.86E+03	1.13E+01	0.00E+00	0.00E+00	82.95	62.62
DEC	2.13E+03	1.15E+01	1.19E+03	5.58E+00	2.07E+03	1.10E+01	3.30E+03	1.70E+01	0.00E+00	0.00E+00	82.82	62.61
TOT	2.19E+04	1.96E+01	1.17E+04	8.50E+00	2.06E+04	1.83E+01	2.49E+04	1.97E+01	0.00E+00	0.00E+00		

1 US ARMY CORPS OF ENGINEERS -- BLAST VERSION 3.0 (ANSI FORTRAN 77) LEVEL 215 5 SEP 95 22: 7: 9 PAGE 35

 **
 ** W L H P S S Y S T E M L O A D S R E P O R T **
 **

SYSTEM NUMBER= 1, WATER LOOP SYSTEM
 SYSTEM LOCATION = 13967 OKLAHOMA CITY/WILL RODGERS, OK SIMULATION PERIOD 1JAN1979 - 31DEC1979

MONTH	ZONE 2				ZONE 3				ZONE 4			
	HEATING		COOLING		HEATING		COOLING		HEATING		COOLING	
	CONSUMPTION/PEAK	CONSUMPTION/PEAK	CONSUMPTION/PEAK	CONSUMPTION/PEAK	CONSUMPTION/PEAK	CONSUMPTION/PEAK	CONSUMPTION/PEAK	CONSUMPTION/PEAK	CONSUMPTION/PEAK	CONSUMPTION/PEAK	CONSUMPTION/PEAK	CONSUMPTION/PEAK
	1000BTU	1000BTU/H	1000BTU	1000BTU/H	1000BTU	1000BTU/H	1000BTU	1000BTU/H	1000BTU	1000BTU/H	1000BTU	1000BTU/H
JAN	9.37E+03	5.09E+01	7.40E+01	8.64E+00	6.07E+03	2.86E+01	2.08E+02	1.38E+01	9.05E+03	4.82E+01	3.97E+01	5.80E+00
FEB	7.13E+03	4.51E+01	4.81E+01	6.87E+00	4.54E+03	2.49E+01	9.63E+01	9.26E+00	6.93E+03	4.28E+01	3.47E+01	6.53E+00
MAR	5.34E+03	3.93E+01	3.17E+02	1.93E+01	3.39E+03	2.32E+01	4.55E+02	1.84E+01	5.24E+03	3.71E+01	2.37E+02	1.62E+01
APR	1.38E+03	1.84E+01	1.74E+03	3.84E+01	8.40E+02	1.11E+01	1.53E+03	2.43E+01	1.48E+03	1.90E+01	1.42E+03	3.42E+01
MAY	4.66E+02	1.35E+01	3.33E+03	4.55E+01	2.66E+02	7.48E+00	2.46E+03	2.81E+01	5.30E+02	1.46E+01	2.91E+03	4.15E+01
JUN	1.49E+02	9.21E+00	6.34E+03	5.99E+01	7.31E+01	5.50E+00	4.15E+03	3.46E+01	1.90E+02	1.02E+01	5.78E+03	5.63E+01
JUL	2.65E+01	6.35E+00	7.03E+03	5.83E+01	1.04E+01	2.10E+00	4.64E+03	3.35E+01	4.42E+01	7.83E+00	6.42E+03	5.40E+01
AUG	6.86E+00	4.67E+00	7.76E+03	5.50E+01	1.82E+00	1.82E+00	5.15E+03	3.28E+01	2.19E+01	7.01E+00	7.08E+03	5.07E+01
SEP	3.03E+02	1.16E+01	4.74E+03	5.63E+01	1.63E+02	7.34E+00	3.27E+03	3.45E+01	3.51E+02	1.23E+01	4.24E+03	5.10E+01
OCT	1.21E+03	1.57E+01	2.18E+03	4.01E+01	7.85E+02	9.60E+00	1.96E+03	2.77E+01	1.28E+03	1.62E+01	1.81E+03	3.52E+01

NOV	1.894E+00	1.841E+00	5.309E-02	3.310E-02	2.000E+00

TOTALS	1.452E+01	1.380E+01	7.178E-01	7.644E-02	1.500E+01

MONTH	HEATING DEMAND FOR ZONE 1000BTU	HEATING PROVIDED BY FAN SYSTEM 1000BTU	HEATING NOT PROVIDED BY FAN SYSTEM 1000BTU	PEAK NOT PROVIDED BY FAN SYSTEM 1000BTU/HR	HOURS NOT PROVIDED (HOURS)
FOR ZONE 3					
FEB	2.474E+00	2.331E+00	1.422E-01	4.700E-02	4.000E+00
MAR	6.057E-01	5.828E-01	2.281E-02	2.281E-02	1.000E+00
APR	6.105E-01	5.828E-01	2.770E-02	2.770E-02	1.000E+00
MAY	1.844E+00	1.749E+00	9.570E-02	4.036E-02	3.000E+00
JUN	6.023E-01	5.828E-01	1.943E-02	1.943E-02	1.000E+00
JUL	6.168E-01	5.828E-01	3.398E-02	3.398E-02	1.000E+00
SEP	1.241E+00	1.165E+00	7.606E-02	4.677E-02	2.000E+00
OCT	6.306E-01	5.828E-01	4.775E-02	4.775E-02	1.000E+00
NOV	6.274E-01	5.828E-01	4.458E-02	4.458E-02	1.000E+00

TOTALS	9.252E+00	8.742E+00	5.102E-01	4.775E-02	1.500E+01

1 US ARMY CORPS OF ENGINEERS -- BLAST VERSION 3.0 (ANSI FORTRAN 77) LEVEL 215 5 SEP 95 22: 7: 9 PAGE 37

MONTH	HEATING DEMAND FOR ZONE 1000BTU	HEATING PROVIDED BY FAN SYSTEM 1000BTU	HEATING NOT PROVIDED BY FAN SYSTEM 1000BTU	PEAK NOT PROVIDED BY FAN SYSTEM 1000BTU/HR	HOURS NOT PROVIDED (HOURS)
FOR ZONE 4					
FEB	1.868E+00	1.749E+00	1.192E-01	6.366E-02	2.000E+00
MAR	1.865E+00	1.749E+00	1.164E-01	6.395E-02	2.000E+00
APR	1.863E+00	1.749E+00	1.142E-01	6.995E-02	2.000E+00
MAY	2.746E+00	2.623E+00	1.231E-01	6.575E-02	3.000E+00
JUN	9.358E-01	8.731E-01	6.267E-02	6.267E-02	1.000E+00
AUG	1.795E+00	1.746E+00	4.931E-02	2.984E-02	2.000E+00
SEP	2.755E+00	2.622E+00	1.339E-01	4.882E-02	3.000E+00
OCT	9.432E-01	8.742E-01	6.897E-02	6.897E-02	1.000E+00
NOV	9.378E-01	8.742E-01	6.353E-02	6.353E-02	1.000E+00
DEC	9.072E-01	8.742E-01	3.301E-02	3.301E-02	1.000E+00

TOTALS	1.662E+01	1.573E+01	8.841E-01	6.995E-02	1.800E+01

MONTH	HEATING DEMAND FOR ZONE 1000BTU	HEATING PROVIDED BY FAN SYSTEM 1000BTU	HEATING NOT PROVIDED BY FAN SYSTEM 1000BTU	PEAK NOT PROVIDED BY FAN SYSTEM 1000BTU/HR	HOURS NOT PROVIDED (HOURS)
FOR ZONE 5					
JAN	5.311E+01	5.061E+01	2.498E+00	2.498E+00	1.000E+00
FEB	2.939E+00	2.792E+00	1.476E-01	7.508E-02	2.000E+00
MAR	1.504E+00	1.396E+00	1.086E-01	1.086E-01	1.000E+00
APR	1.448E+00	1.396E+00	5.197E-02	5.197E-02	1.000E+00
MAY	4.343E+00	4.187E+00	1.559E-01	1.008E-01	3.000E+00
SEP	1.484E+00	1.396E+00	8.808E-02	8.808E-02	1.000E+00

OCT	7.476E+00	6.979E+00	4.976E-01	1.199E-01	5.000E+00
NOV	1.486E+00	1.396E+00	8.995E-02	8.995E-02	1.000E+00
DEC	2.929E+00	2.791E+00	1.373E-01	7.248E-02	2.000E+00

TOTALS	7.672E+01	7.294E+01	3.775E+00	2.498E+00	1.700E+01

F A N S Y S T E M U N D E R C O O L I N G

FOR ZONE 2
NO UNDERCOOLING FOR THIS ZONE

FOR ZONE 3
NO UNDERCOOLING FOR THIS ZONE
1 US ARMY CORPS OF ENGINEERS -- BLAST VERSION 3.0 (ANSI FORTRAN 77) LEVEL 215 5 SEP 95 22: 7: 9 PAGE 38

FOR ZONE 4
NO UNDERCOOLING FOR THIS ZONE

FOR ZONE 5
NO UNDERCOOLING FOR THIS ZONE
1 US ARMY CORPS OF ENGINEERS -- BLAST VERSION 3.0 (ANSI FORTRAN 77) LEVEL 215 5 SEP 95 22: 7: 9 PAGE 39

**
** F A N S Y S T E M O V E R H E A T I N G / O V E R C O O L I N G S U M M A R Y **
**

SYSTEM NUMBER= 1, WATER LOOP SYSTEM
SYSTEM LOCATION = 13967 OKLAHOMA CITY/WILL RODGERS, OK SIMULATION PERIOD 1JAN1979 - 31DEC1979

F A N S Y S T E M O V E R H E A T I N G

FOR ZONE 2
NO OVERHEATING FOR THIS ZONE

FOR ZONE 3
NO OVERHEATING FOR THIS ZONE

FOR ZONE 4
NO OVERHEATING FOR THIS ZONE

FOR ZONE 5
NO OVERHEATING FOR THIS ZONE

FAN SYSTEM OVERCOOLING

FOR ZONE 2
NO OVERCOOLING FOR THIS ZONE

MONTH	COOLING DEMAND FOR ZONE 1000BTU	COOLING PROVIDED BY FAN SYSTEM 1000BTU	EXCESS COOLING PRO- VIDED BY FAN SYSTEM 1000BTU	EXCESS PEAK PRO- VIDED BY FAN SYSTEM 1000BTU/HR	HOURS EXCESS PROVIDED (HOURS)
-------	---------------------------------------	--	---	---	-------------------------------------

FOR ZONE 3

JAN	3.902E+00	3.947E+00	4.468E-02	4.468E-02	1.000E+00
FEB	2.487E+00	2.506E+00	1.841E-02	1.841E-02	1.000E+00
MAY	1.067E+00	1.118E+00	5.069E-02	5.069E-02	1.000E+00
NOV	2.116E+00	2.160E+00	4.449E-02	4.449E-02	1.000E+00

TOTALS 9.572E+00 9.730E+00 1.583E-01 5.069E-02 4.000E+00

1 US ARMY CORPS OF ENGINEERS -- BLAST VERSION 3.0 (ANSI FORTRAN 77) LEVEL 215 5 SEP 95 22: 7: 9 PAGE 40

MONTH	COOLING DEMAND FOR ZONE 1000BTU	COOLING PROVIDED BY FAN SYSTEM 1000BTU	EXCESS COOLING PRO- VIDED BY FAN SYSTEM 1000BTU	EXCESS PEAK PRO- VIDED BY FAN SYSTEM 1000BTU/HR	HOURS EXCESS PROVIDED (HOURS)
-------	---------------------------------------	--	---	---	-------------------------------------

FOR ZONE 4

OCT	3.115E+00	3.190E+00	7.578E-02	7.578E-02	1.000E+00
-----	-----------	-----------	-----------	-----------	-----------

TOTALS 3.115E+00 3.190E+00 7.578E-02 7.578E-02 1.000E+00

MONTH	COOLING DEMAND FOR ZONE 1000BTU	COOLING PROVIDED BY FAN SYSTEM 1000BTU	EXCESS COOLING PRO- VIDED BY FAN SYSTEM 1000BTU	EXCESS PEAK PRO- VIDED BY FAN SYSTEM 1000BTU/HR	HOURS EXCESS PROVIDED (HOURS)
-------	---------------------------------------	--	---	---	-------------------------------------

FOR ZONE 5

FEB	2.124E-01	2.495E-01	3.715E-02	3.715E-02	1.000E+00
JUN	1.760E+00	1.818E+00	5.797E-02	5.797E-02	1.000E+00

TOTALS 1.973E+00 2.068E+00 9.512E-02 5.797E-02 2.000E+00

1 US ARMY CORPS OF ENGINEERS -- BLAST VERSION 3.0 (ANSI FORTRAN 77) LEVEL 215 5 SEP 95 22: 7: 9 PAGE 41

** FAN SYSTEM HEATING / COOLING WITHOUT DEMAND SUMMARY **

SYSTEM NUMBER= 1, WATER LOOP SYSTEM
 SYSTEM LOCATION = 13967 OKLAHOMA CITY/WILL RODGERS, OK SIMULATION PERIOD 1JAN1979 - 31DEC1979

H E A T I N G W I T H O U T D E M A N D

FOR ZONE 2
 NO HEATING WITHOUT DEMAND FOR THIS ZONE

FOR ZONE 3
 NO HEATING WITHOUT DEMAND FOR THIS ZONE

FOR ZONE 4
 NO HEATING WITHOUT DEMAND FOR THIS ZONE

FOR ZONE 5
 NO HEATING WITHOUT DEMAND FOR THIS ZONE

C O O L I N G W I T H O U T D E M A N D

FOR ZONE 2
 NO COOLING WITHOUT DEMAND FOR THIS ZONE

FOR ZONE 3
 NO COOLING WITHOUT DEMAND FOR THIS ZONE

FOR ZONE 4
 NO COOLING WITHOUT DEMAND FOR THIS ZONE

1 US ARMY CORPS OF ENGINEERS -- BLAST VERSION 3.0 (ANSI FORTRAN 77) LEVEL 215 5 SEP 95 22: 7: 9 PAGE 42

MONTH	COOLING DEMAND FOR ZONE 1000BTU	COOLING PROVIDED BY FAN SYSTEM 1000BTU	EXCESS COOLING PROVIDED BY FAN SYSTEM 1000BTU	EXCESS PEAK PROVIDED BY FAN SYSTEM 1000BTU/HR	HOURS EXCESS PROVIDED (HOURS)
-------	------------------------------------	---	--	--	----------------------------------

FOR ZONE 5					
SEP	0.000E+00	8.031E-02	8.031E-02	8.031E-02	1.000E+00

TOTALS	0.000E+00	8.031E-02	8.031E-02	8.031E-02	1.000E+00
--------	-----------	-----------	-----------	-----------	-----------

1 US ARMY CORPS OF ENGINEERS -- BLAST VERSION 3.0 (ANSI FORTRAN 77) LEVEL 215 5 SEP 95 22: 7: 9 PAGE 43

 **

** REVIEW SUMMARY REPORT **
 **

1 BUILDING WITH 6 ZONES
 1 SYSTEM
 0 PLANTS
 OUTPUT UNITS IN ENGLISH
 PROJECT = DAYCARE CENTER

SIMULATION PERIOD = 1 JAN 1979 - 31 DEC 1979
 LOCATION = OKLAHOMA CITY/WILL RODGERS, OK
 HEATING DEGREE DAYS = 3869.0
 COOLING DEGREE DAYS = 1820.9
 GROUND TEMPS = 55,55,55,55,55,55,55,55,55,55

FOR ZONE 1	"MECHANICAL ROOM	"	FLOOR AREA	204.19 FT**2
CEILING HEIGHT	8.0 FT	APPROXIMATED VOLUME	1634. FT**3	
FOR ZONE 2	"SMURF ROOM	"	FLOOR AREA	1041.01 FT**2
CEILING HEIGHT	8.0 FT	APPROXIMATED VOLUME	8328. FT**3	
FOR ZONE 3	"RECEPTION	"	FLOOR AREA	515.62 FT**2
CEILING HEIGHT	8.0 FT	APPROXIMATED VOLUME	4125. FT**3	
FOR ZONE 4	"MUPPET ROOM	"	FLOOR AREA	1276.47 FT**2
CEILING HEIGHT	8.0 FT	APPROXIMATED VOLUME	10212. FT**3	
FOR ZONE 5	"SHORT TALES ROOM	"	FLOOR AREA	1829.40 FT**2
CEILING HEIGHT	8.0 FT	APPROXIMATED VOLUME	14636. FT**3	
FOR ZONE 6	"ATTIC	"	FLOOR AREA	4827.51 FT**2
CEILING HEIGHT	5.0 FT	APPROXIMATED VOLUME	24129. FT**3	

1 US ARMY CORPS OF ENGINEERS -- BLAST VERSION 3.0 (ANSI FORTRAN 77) LEVEL 215 5 SEP 95 22: 7: 9 PAGE 44

 *** PLAN VIEW OF BUILDING SURFACES ***

MIN X = -77.07 FT
 MAX X = 33.94 FT
 MIN Y = 6.89 FT
 MAX Y = 119.68 FT
 SOLAR DISTRIBUTION = -1

* = BUILDING SURFACE, + = SHADOWING SURFACE

Y+	N
1	1
-X-+--+X	W-+--+E
1	1
-Y	S

BUILDING TITLE - DAYCARE CENTER

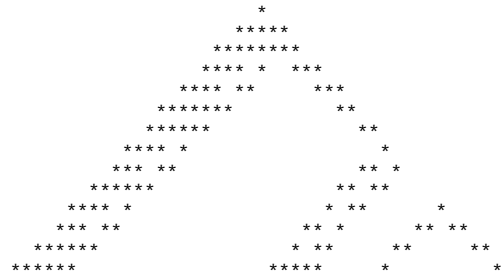

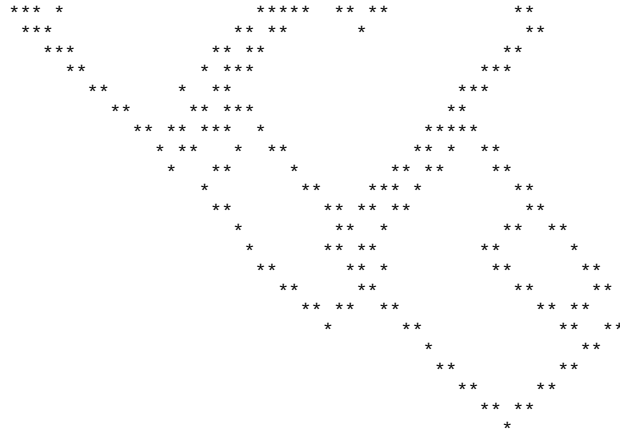

 *** BUILDING ENVELOPE DATA ***

NOTE ** SURFACES IN ZONES DESIGNATED AS ATTIC OR CRAWLSPACE ARE NOT INCLUDED

*NORTH= 0.
 EAST= 90.0

	AREA (FT**2)	U (B/H*F**2*R)	AZIMUTH* (DEGREES)	TILT (DEGREES)	PER CENT GLAZING
ROOF	4850.00	0.222	*****	0.0	0.0
ROOF1	4850.00	0.222	*****	0.0	0.0
EXTERIOR WALL	1100.84	0.061	135.0	90.0	0.4
WALL1	1051.34	0.045	135.0	90.0	
DOOR1	21.00	0.568	135.0	90.0	
SINGLE PANE HW WINDOW	4.00	1.115	135.0	90.0	
METAL INSULATED DOOR	24.50	0.138	135.0	90.0	
EXTERIOR WALL	1417.21	0.084	45.0	90.0	0.9
WALL1	1326.89	0.045	45.0	90.0	
DOOR1	77.00	0.568	45.0	90.0	
SINGLE PANE HW WINDOW	13.32	1.115	45.0	90.0	
EXTERIOR WALL	1139.92	0.072	225.0	90.0	2.5
WALL1	1111.92	0.045	225.0	90.0	
SINGLE PANE HW WINDOW	28.00	1.115	225.0	90.0	
WALL TO UNCOOLED SPACE	143.04	0.046	45.0	90.0	0.0
WALL1	143.04	0.046	45.0	90.0	
WALL TO UNCOOLED SPACE	91.36	0.046	135.0	90.0	0.0
WALL1	91.36	0.046	135.0	90.0	

EXTERIOR WALL	78.00	0.390	135.0	90.0	0.0
WALL2	78.00	0.390	135.0	90.0	
EXTERIOR WALL	1178.71	0.085	315.0	90.0	2.4
WALL1	1066.71	0.045	315.0	90.0	
DOOR1	21.00	0.568	315.0	90.0	
SINGLE PANE HW WINDOW	28.00	1.115	315.0	90.0	
METAL INSULATED DOOR	63.00	0.138	315.0	90.0	
EXTERIOR WALL	275.21	0.480	225.0	90.0	5.3
WALL2	239.51	0.390	225.0	90.0	
SINGLE PANE HW WINDOW	14.70	1.115	225.0	90.0	
GLASS DOOR	21.00	1.059	225.0	90.0	

1 US ARMY CORPS OF ENGINEERS -- BLAST VERSION 3.0 (ANSI FORTRAN 77) LEVEL 215 5 SEP 95 22: 7: 9 PAGE 46

 *** BUILDING ENVELOPE DATA ***

NOTE ** SURFACES IN ZONES DESIGNATED AS ATTIC OR CRAWLSPACE ARE NOT INCLUDED

	AREA (FT**2)	U (B/H*F**2*R)	AZIMUTH* (DEGREES)	TILT (DEGREES)	PER CENT GLAZING	*NORTH= 0. EAST= 90.0
SLAB ON GRADE FLOOR	4866.69	0.258	****	180.0	0.0	
FLOOR1	4866.69	0.258	****	180.0		
	=====	=====			=====	
	15140.98	0.102 (OVERALL WALL AVERAGE)			1.7 PERCENT OF TOTAL WALL AREA	
		0.190 (BUILDING OVERALL AVERAGE)			0.9 PERCENT OF TOTAL FLOOR AREA	

FLOOR AREA OF BUILDING = 9694.21 FT**2
 APPROX EXTERIOR SURFACE AREA = 15140.98 FT**2
 APPROXIMATE VOLUME = 63063.42 FT**3
 APPROX VOLUME / FLOOR AREA = 6.5 FT (APPROXIMATE BUILDING WALL HEIGHT)

1 US ARMY CORPS OF ENGINEERS -- BLAST VERSION 3.0 (ANSI FORTRAN 77) LEVEL 215 5 SEP 95 22: 7: 9 PAGE 47

 *** SURFACE CONSTRUCTIONS ***

U
 WITHOUT FILM COEFF
 (B/H*F**2*R)

WALL1 0.047
 A7 - 4 IN FACE BRICK 2.312
 B1 - AIRSPACE RESISTANCE 1.099
 PLASTER - GYPSUM LWA 5 / 8 IN 2.495

INS - MINERAL FIBER FIBROUS 6 IN	0.053						
PLASTER - GYPSUM LWA 5 / 8 IN	2.495						
DOOR1	1.098						
METAL - GALVANIZED STEEL 1 / 16 IN	5038.461						
B1 - AIRSPACE RESISTANCE	1.099						
METAL - GALVANIZED STEEL 1 / 16 IN	5038.461						
FLOOR1	0.313						
CONCRETE - DRIED SAND AND GRAVEL 6 IN	1.500						
BUILDING MEMBRANE - MOPPED FELT	8.333						
C5 - 4 IN HW CONCRETE	3.003						
FINISH FLOORING - CARPET FIBROUS PAD	0.481						
CEILING1	0.048						
PLASTER - GYPSUM LWA 5 / 8 IN	2.495						
E4 - CEILING AIRSPACE	1.000						
INS - MINERAL FIBER FIBROUS 6 IN	0.053						
PLASTER - GYPSUM LWA 5 / 8 IN	2.495						
SINGLE PANE HW WINDOW	21.186						
GLASS - CLEAR PLATE 1 / 4 IN	21.186						
WALL2	0.584						
PLASTER - GYPSUM LWA 5 / 8 IN	2.495						
B1 - AIRSPACE RESISTANCE	1.099						
PLASTER - GYPSUM LWA 5 / 8 IN	2.495						
SOLID WOOD DOOR	0.419						
B10 - 2 IN WOOD	0.419						
GLASS DOOR	10.593						
GLASS - CLEAR PLATE 1 / 2 IN	10.593						
METAL INSULATED DOOR	0.157						
METAL - GALVANIZED STEEL 1 / 16 IN	5038.461						
INS - EXPANDED POLYURETHANE R11 1 IN	0.157						
METAL - GALVANIZED STEEL 1 / 16 IN	5038.461						
1 US ARMY CORPS OF ENGINEERS -- BLAST VERSION 3.0 (ANSI FORTRAN 77)		LEVEL 215	5 SEP 95	22: 7: 9	PAGE	48	

 *** SURFACE CONSTRUCTIONS ***

U
 WITHOUT FILM COEFF
 (B/H**F**2*R)

FLOOR2	0.048						
PLASTER - GYPSUM LWA 5 / 8 IN	2.495						
E4 - CEILING AIRSPACE	1.000						
INS - MINERAL FIBER FIBROUS 6 IN	0.053						
PLASTER - GYPSUM LWA 5 / 8 IN	2.495						

ROOF1 0.273 3.003
 ROOFING - BUILT UP ROOFING - 3 / 8 IN 0.300
 C14 - 4 IN LW CONCRETE
 1 US ARMY CORPS OF ENGINEERS -- BLAST VERSION 3.0 (ANSI FORTRAN 77) LEVEL 215 5 SEP 95 22: 7: 9 PAGE 49

 *** FAN SYSTEM DATA ***

SYSTEM 1 WATER LOOP HEAT PUMP WATER LOOP SYSTEM
 SERVING ZONES: 2, 3, 4, 5

MIXED AIR CONTROL = FIXED PERCENT DESIRED MIXED AIR TEMP = 74 DEG. F
 COLD DECK CONTROL = FIXED SET POINT COLD DECK FIXED TEMP = 60 DEG. F
 HOT DECK CONTROL = FIXED SET POINT HOT DECK FIXED TEMP = 80 DEG. F

SYSTEM OPERATION = FAN OPERATION, 1JAN THRU 31DEC EXHAUST FAN OPERATION = FAN OPERATION, 1JAN THRU 31DEC
 PREHEAT COIL OPERATION =ON,01JAN THRU 31DEC HEATING COIL OPERATION = OFF, 1JAN THRU 31DEC
 COOLING COIL OPERATION = OFF, 1JAN THRU 31DEC HUMIDIFIER OPERATION =ON,01JAN THRU 31DEC
 TSTAT BASEBOARD HEAT OPERATION = OFF, 1JAN THRU 31DEC HEAT RECOVERY OPERATION = OFF, 1JAN THRU 31DEC
 MINIMUM VENTILATION SCHEDULE = FAN OPERATION, 1JAN THRU 31DEC
 MAXIMUM VENTILATION SCHEDULE = FAN OPERATION, 1JAN THRU 31DEC
 SYSTEM ELECTRICAL DEMAND SCHEDULE = ON, 1JAN THRU 31DEC
 EVAPORATIVE COOLER OPERATION =ON,01JAN THRU 31DEC HEAT PUMP BACKUP HEAT OPERATION =ON,01JAN THRU 31DEC
 HEAT PUMP COOLING OPERATION =ON,01JAN THRU 31DEC HEAT PUMP HEATING OPERATION =ON,01JAN THRU 31DEC
 WLHPS STORAGE TANK OPERATION = OFF, 1JAN THRU 31DEC
 WLHPS VENTILATION SYSTEM OPERATIO = FAN OPERATION, 1JAN THRU 31DEC
 WLHPS LOOP CONTROL SCHEDULE = OFF, 1JAN THRU 31DEC
 VAV MINIMUM AIR FRACTION SCHEDULE =ON,01JAN THRU 31DEC

ZONE	SUPPLY AIR VOLUME FT**3/MIN	MINIMUM AIR FRACTION	EXHAUST AIR VOLUME FT**3/MIN	REHEAT CAPACITY 1000BTU	BASEBOARD HEAT CAPACITY 1000BTU	RECOOL CAPACITY 1000BTU	ZONE MULTIPLIER
2	3.750E+02	0.00	0.000E+00	0.000E+00	0.000E+00	0.000E+00	1
3	1.500E+02	0.00	0.000E+00	0.000E+00	0.000E+00	0.000E+00	1
4	3.750E+02	0.00	0.000E+00	0.000E+00	0.000E+00	0.000E+00	1
5	4.500E+02	0.00	0.000E+00	0.000E+00	0.000E+00	0.000E+00	1

***** NO PLANTS WERE SIMULATED *****

1 US ARMY CORPS OF ENGINEERS -- BLAST VERSION 3.0 (ANSI FORTRAN 77) LEVEL 215 5 SEP 95 22: 7: 9 PAGE 50

 *** SCHEDULED LOADS ***

ZONE NUMBER	FROM	THRU	SCHEDULE	DESIGN PEAK LOAD	DESIGN PEAK LOAD PER FT**2	# HOURS PER WEEK	AVERAGE LOAD WHEN LOAD SCHEDULED
1	US ARMY	CORPS OF ENGINEERS	-- BLAST VERSION 3.0 (ANSI FORTRAN 77)	LEVEL 215	5 SEP 95	22: 7: 9	PAGE 51

 *** SCHEDULED LOADS ***

ZONE NUMBER	FROM	THRU	SCHEDULE	DESIGN PEAK LOAD	DESIGN PEAK LOAD PER FT**2	# HOURS PER WEEK	AVERAGE LOAD WHEN LOAD SCHEDULED
PEOPLE:							
2	1JAN	31DEC	FAN OPERATION	25.0	PEOPLE	2.402E-02	45.0 2.500E+01 PEOPLE
3	1JAN	31DEC	FAN OPERATION	10.0	PEOPLE	1.939E-02	45.0 1.000E+01 PEOPLE
4	1JAN	31DEC	FAN OPERATION	25.0	PEOPLE	1.959E-02	45.0 2.500E+01 PEOPLE
5	1JAN	31DEC	FAN OPERATION	30.0	PEOPLE	1.640E-02	45.0 3.000E+01 PEOPLE
LIGHTS:							
2	1JAN	31DEC	OFFICE LIGHTING	1.70	1000BTU	1.633E-03	168. 5.960E-01 1000BTU
3	1JAN	31DEC	OFFICE LIGHTING	0.850	1000BTU	1.649E-03	168. 2.980E-01 1000BTU
4	1JAN	31DEC	OFFICE LIGHTING	1.87	1000BTU	1.465E-03	168. 6.556E-01 1000BTU
5	1JAN	31DEC	OFFICE LIGHTING	2.04	1000BTU	1.115E-03	168. 7.152E-01 1000BTU

NO ELECT EQUIP:

NO GAS EQUIP:

OTHER EQUIP LOADS:

NEGATIVE AMOUNTS DENOTE LOSS, POSITIVE AMOUNTS DENOTE GAIN

OTHER EQUIPMENT LOADS ARE NOT INCLUDED IN ENERGY BUDGET FIGURES.

1	1JAN	31DEC	OFFICE OCCUPANCY	13.7	1000BTU	6.685E-02	60.0 9.896E+00 1000BTU
2	1JAN	31DEC	OFFICE OCCUPANCY	8.50	1000BTU	8.165E-03	60.0 6.163E+00 1000BTU
3	1JAN	31DEC	OFFICE OCCUPANCY	5.10	1000BTU	9.891E-03	60.0 3.698E+00 1000BTU
4	1JAN	31DEC	OFFICE OCCUPANCY	8.50	1000BTU	6.659E-03	60.0 6.163E+00 1000BTU
5	1JAN	31DEC	OFFICE OCCUPANCY	5.10	1000BTU	2.788E-03	60.0 3.698E+00 1000BTU

 *** INFILTRATION AND VENTILATION ***

NUMBER	FROM	THRU	SCHEDULE	OCCUPIED		UNOCCUPIED		SPECIFIED PEAK FLOW
				MAX	MIN	MAX	MIN	
1	US ARMY	CORPS OF ENGINEERS	-- BLAST VERSION 3.0 (ANSI FORTRAN 77)	LEVEL 215	5 SEP 95	22: 7: 9	PAGE 52	

 *** INFILTRATION AND VENTILATION ***

NUMBER	FROM	THRU	SCHEDULE	OCCUPIED		UNOCCUPIED		SPECIFIED PEAK FLOW
				MAX	MIN	MAX	MIN	

INFILTRATION:

1	1JAN 31DEC	CONSTANT	AIR CH/HR	*****	*****	3.9	0.7		1.1
			FT**3/MIN	*****	*****	1.1E+02	1.9E+01		3.0E+01
			MO/DA/HR	*****	*****	3/ 2/15	6/19/ 6		
2	1JAN 31DEC	CONSTANT	AIR CH/HR	3.4	0.6	3.4	0.6		1.0
			FT**3/MIN	4.7E+02	8.7E+01	4.7E+02	8.5E+01		1.4E+02
			MO/DA/HR	3/ 2/ 9	11/ 1/15	3/ 2/ 6	8/14/ 5		
3	1JAN 31DEC	CONSTANT	AIR CH/HR	3.7	0.7	3.7	0.7		1.1
			FT**3/MIN	2.6E+02	4.8E+01	2.6E+02	4.7E+01		7.5E+01
			MO/DA/HR	3/ 2/ 9	11/ 1/15	3/ 2/ 6	8/14/ 5		
4	1JAN 31DEC	CONSTANT	AIR CH/HR	2.5	0.5	2.5	0.4		0.7
			FT**3/MIN	4.2E+02	8.0E+01	4.2E+02	7.5E+01		1.2E+02
			MO/DA/HR	3/ 2/ 9	11/ 1/15	3/ 2/ 6	6/ 6/24		
5	1JAN 31DEC	CONSTANT	AIR CH/HR	3.4	0.7	3.4	0.6		1.0
			FT**3/MIN	8.4E+02	1.6E+02	8.4E+02	1.5E+02		2.5E+02
			MO/DA/HR	3/ 2/ 9	11/ 1/15	3/ 2/ 6	8/14/ 5		
6	1JAN 31DEC	CONSTANT	AIR CH/HR	*****	*****	3.0	0.6		1.0
			FT**3/MIN	*****	*****	1.2E+03	2.5E+02		4.0E+02
			MO/DA/HR	*****	*****	3/ 2/ 5	11/ 1/15		

INFILTRATION HEAT LOSS = 93981.19 1000BTU, 71.1 PERCENT OF THE HEATING LOAD

INFILTRATION HEAT GAIN = 11243.96 1000BTU, 19.0 PERCENT OF THE COOLING LOAD

NO NATURAL VENTILATION:

1 US ARMY CORPS OF ENGINEERS -- BLAST VERSION 3.0 (ANSI FORTRAN 77) LEVEL 215 5 SEP 95 22: 7: 9 PAGE 53

 *** MECHANICAL VENTILATION ***

NUMBER	FROM THRU		OCCUPIED		UNOCCUPIED		PEAK FLOW	
			MAX	MIN	MAX	MIN		
OUTSIDE AIR:								
SYS 1	1JAN THRU 31DEC,	FAN OPERATION	FT**3/MIN	1.4E+03	0.0E+00	1.4E+03	0.0E+00	1.4E+03
			MO/DA/HR	1/ 2/ 9	1/ 2/ 7	1/ 3/19	1/ 1/ 1	

 *** SPACE TEMPERATURES DEG. F ***

ZONE NUMBER	CONTROLS	HEATING				COOLING				NO HEATING OR COOLING					
		OCCUPIED		UNOCCUPIED		OCCUPIED		UNOCCUPIED		OCCUPIED		UNOCCUPIED			
		MAX	MIN	MAX	MIN	MAX	MIN	MAX	MIN	MAX	MIN	MAX	MIN		
1	*****NO CONTROLS*****	*****	*****	*****	*****	*****	*****	*****	*****	*****	*****	*****	*****	142.69	22.20

2	DC	70.30	68.01	72.26	59.21	73.12	69.99	81.36	72.62	73.00	68.25	81.30	59.42
3	DC	72.20	67.96	74.25	59.77	73.14	67.61	80.86	71.20	72.90	68.12	80.89	59.83
4	DC	70.44	68.87	72.29	59.49	73.34	70.80	73.25	73.14	73.31	69.11	78.26	59.62
5	DC	70.52	68.80	72.07	59.79	73.02	71.15	81.04	72.84	73.00	68.79	81.07	60.03

6 *****NO CONTROLS*****
 1 US ARMY CORPS OF ENGINEERS -- BLAST VERSION 3.0 (ANSI FORTRAN 77) LEVEL 215 5 SEP 95 22: 7: 9 PAGE 54

 *** ZONES ENERGY BUDGET ***

CATEGORY CODE = 74014
 FACILITY CATEGORY = Community Facilities (MWR)
 LOCATION = OKLAHOMA CITY/WILL RODGERS, OK
 PROJECT TITLE = DAYCARE CENTER

SIMULATION PERIOD = 1 JAN 1979 - 31 DEC 1979
 BUDGET REGION = 4
 HEATING DEGREE DAYS = 3869.0
 COOLING DEGREE DAYS = 1820.9
 REQUIRED ENERGY BUDGET= 45

ZONE LOAD

NUMBER	TOTAL HEAT 1000BTU	TOTAL COOL 1000BTU	TOTAL ELECT 1000BTU	TOTAL GAS 1000BTU	INFIL LOSS 1000BTU	INFIL GAIN 1000BTU	TOTAL AREA FT**2	ENERGY BUDGET 1000BTU / FT**2
1	0.000E+00	0.000E+00	0.000E+00	0.000E+00	0.000E+00	0.000E+00	2.042E+02	0.000E+00
2	2.803E+04	1.681E+04	5.071E+03	0.000E+00	2.144E+04	2.735E+03	1.041E+03	4.795E+01
3	2.014E+04	1.461E+04	2.536E+03	0.000E+00	1.195E+04	1.908E+03	5.156E+02	7.232E+01
4	2.728E+04	1.480E+04	5.579E+03	0.000E+00	1.895E+04	2.246E+03	1.276E+03	3.733E+01
5	5.673E+04	1.305E+04	6.086E+03	0.000E+00	4.164E+04	4.355E+03	1.829E+03	4.147E+01
6	0.000E+00	0.000E+00	0.000E+00	0.000E+00	0.000E+00	0.000E+00	4.828E+03	0.000E+00
	=====	=====	=====	=====	=====	=====	=====	=====
TOTAL	1.322E+05	5.927E+04	1.927E+04	0.000E+00	9.398E+04	1.124E+04	9.694E+03	

ENERGY BUDGET FOR ALL ZONES = 2.174E+01 1000BTU / FT**2

*** ZONE ENERGY BUDGETS DO NOT INCLUDE FAN SYSTEMS OR EQUIPMENT INEFFICIENCIES
 1 US ARMY CORPS OF ENGINEERS -- BLAST VERSION 3.0 (ANSI FORTRAN 77) LEVEL 215 5 SEP 95 22: 7: 9 PAGE 55

 *** SYSTEMS ENERGY BUDGET ***

CATEGORY CODE = 74014
 FACILITY CATEGORY = Community Facilities (MWR)
 LOCATION = OKLAHOMA CITY/WILL RODGERS, OK
 PROJECT TITLE = DAYCARE CENTER

SIMULATION PERIOD = 1 JAN 1979 - 31 DEC 1979
 BUDGET REGION = 4
 HEATING DEGREE DAYS = 3869.0
 COOLING DEGREE DAYS = 1820.9
 REQUIRED ENERGY BUDGET= 45

SYSTEM LOADS

NUMBER	UNDER HEAT		UNDER COOL		OVER HEAT		OVER COOL		HEAT W/O DMD		COOL W/O DMD	
	1000BTU	HOURS	1000BTU	HOURS	1000BTU	HOURS	1000BTU	HOURS	1000BTU	HOURS	1000BTU	HOURS
1	5.887E+00	(65)	0.000E+00	(0)	0.000E+00	(0)	3.292E-01	(7)	0.000E+00	(0)	8.031E-02	(1)
	=====		=====		=====		=====		=====		=====	
TOTAL	5.887E+00	(65)	0.000E+00	(0)	0.000E+00	(0)	3.292E-01	(7)	0.000E+00	(0)	8.031E-02	(0)

NUMBER	TOTAL HEAT	TOTAL COOL	TOTAL ELECT	TOTAL GAS	TOTAL AREA	ENERGY BUDGET	
	1000BTU	1000BTU	1000BTU	1000BTU	FT**2	1000BTU /	FT**2
1	1.181E+05	1.539E+05	1.044E+05	0.000E+00	4.663E+03	8.072E+01	
	=====	=====	=====	=====	=====		
TOTAL	1.181E+05	1.539E+05	1.044E+05	0.000E+00	4.663E+03		

ENERGY BUDGET FOR ALL SYSTEMS = 8.072E+01 1000BTU / FT**2

*** ENERGY BUDGET DOES NOT INCLUDE UNDER/OVER/W.O. DEMAND HEATING/COOLING ITEMS

***** NO PLANT INFORMATION AVAILABLE *****

1 US ARMY CORPS OF ENGINEERS -- BLAST VERSION 3.0 (ANSI FORTRAN 77) LEVEL 215 5 SEP 95 22: 7: 9 PAGE 56

PSYCHROMETRIC ERROR SUMMARY
0 CUMULATIVE FOR ENTIRE RUN

ROUTINE	NUMBER OF ERRORS
PSYDPT	0
PSYRHT	0
PSYTW	0
PSYVTW	0
PSYWDP	0
PSYWTH	0
PSYWTP	0
PSYWTR	0
SATUPT	0
SATUTH	0
SATUTP	0

APPENDIX E.6

GLHEPRO INPUT FILE FOR THE DAYCARE CENTER

Borehole Profile and Monthly Loadings Table

Active Borehole Depth 200.000
 Borehole Radius 3.000
 Thermal conductivity of the ground. 1.400
 Volumetric heat capacity of the ground. . . . 35.000
 Volumetric heat capacity of the fluid 62.400
 Undisturbed ground temperature. 61.00
 Borehole thermal resistance 0.173
 Mass flow rate of the fluid 40.000
 Density of the fluid. 62.400
 G-function filename g1020.gfc
 Units of input data (1 = IP, 2 = SI). 1
 Units of output data (1 = IP, 2 = SI) 1

Monthly Loadings
 =====

Month	Heating	Cooling
January	13070000.000	0.000
Febraury	10560000.000	47580.000
March	8706000.000	0.000
April	2602000.000	65500.000
May	20350.000	2873000.000
June	23010.000	7161000.000
July	6062.000	9478000.000
August	13950.000	11010000.000
September	23760.000	4036000.000
October	443300.000	500700.000
November	5726000.000	4980.000
December	13960000.000	7234.000

The first month you want data for 1.00
 The last month you want data for. 120.00
 Desired exiting fluid temperature 0.00
 The desired temp is (1=min, 2=max). 1

Heat pump curve fit equations and coefficients:

Cooling: Heat of Rejection = QC[a+b(EFT)+c(EFT^2)]
 Power = QC[d+e(EFT)+f(EFT^2)]

a = 1.000000
 b = 0.000000
 c = 0.000000
 d = 0.000000
 e = 0.000000
 f = 0.000000

Heating: Heat of Absorption = QH[a+b(EFT)+c(EFT^2)]
 Power = QH[d+e(EFT)+f(EFT^2)]

a = 1.000000
 b = 0.000000
 c = 0.000000

d = 0.000000
e = 0.000000
f = 0.000000

Output data will be sent to: glhepro.out

B/H = 20
Fluid type currently entered: Pure Water

APPENDIX E.7

BLAST AND GLHEPRO OUTPUT FILES FOR THE DAYCARE CENTER FOR A
TEN YEAR SIMULATION USING THE MODIFIED CODE

0 REPORTING WILL BE DONE IN UNITS ENGLISH
0 SIMULATIONS WILL BE ALLOWED FOR TYPES% ZONES SYSTEMS PLANTS

1 BUILDING SIMULATIONS WILL BE ATTEMPTED

SIMULATIONS WILL BE ATTEMPTED FOR 6 ZONES

SIMULATIONS WILL BE ATTEMPTED FOR 1 SYSTEMS

SIMULATIONS WILL BE ATTEMPTED FOR 0 PLANTS

0 NEW BLDLFL AND AHLDFL FILES WILL BE CREATED
FROM USER INPUT, AS NECESSARY

0 LOCATION TAKEN FROM ATTACHED WTHRFL
TITLE= OKLAHOMA CITY/WILL RODGERS, OK LAT= 35.400 LONG= 97.600 TIME ZONE= 6.0

0 * * * * *
BLDFL FOR
DAYCARE CENTER

LOCATION OKLAHOMA CITY/WILL RODGERS, OK LAT= 35.400 LONG= 97.600 TIME ZONE= 6.0
DATE OF FILE CREATE/UPDATE 15 SEP 95 NUMBER OF ENVIRONMENTS 1
NUMBER OF ZONES 6 WITH ZONE NUMBERS
1 2 3 4 5 6

0 * * * * *
AHLDFL FOR
DAYCARE CENTER

LOCATION OKLAHOMA CITY/WILL RODGERS, OK LAT= 35.400 LONG= 97.600 TIME ZONE= 6.0
DATE OF FILE CREATE/UPDATE 15 SEP 95 NUMBER OF ENVIRONMENTS 1
NUMBER OF SYSTEMS 1 WITH SYSTEM NUMBERS
1

***** SIMULATION PERIOD 1 JAN 1979 THRU 31 DEC 1979

0 ENVIRONMENT NUMBER 1 FOR BLDLFL TITLE IS OKLAHOMA CITY/WILL RODGERS, OK
WEATHER STATION 13967 START DATE OF 1 JAN 1979 NO. OF DAYS 365
WITH GROUND TEMPERATURES JAN =55.00 FEB =55.00 MAR =55.00 APR =55.00 MAY =55.00 JUN =55.00
JUL =55.00 AUG =55.00 SEP =55.00 OCT =55.00 NOV =55.00 DEC =55.00
WITH MAKE UP WATER TEMPERATURES JAN =55.00 FEB =55.00 MAR =55.00 APR =55.00 MAY =55.00 JUN =55.00
JUL =55.00 AUG =55.00 SEP =55.00 OCT =55.00 NOV =55.00 DEC =55.00
0 ENVIRONMENT NUMBER 1 FOR AHLDFL TITLE IS OKLAHOMA CITY/WILL RODGERS, OK
WEATHER STATION 13967 START DATE OF 1 JAN 1979 NO. OF DAYS 365
WITH GROUND TEMPERATURES JAN =55.00 FEB =55.00 MAR =55.00 APR =55.00 MAY =55.00 JUN =55.00
JUL =55.00 AUG =55.00 SEP =55.00 OCT =55.00 NOV =55.00 DEC =55.00
WITH MAKE UP WATER TEMPERATURES JAN =55.00 FEB =55.00 MAR =55.00 APR =55.00 MAY =55.00 JUN =55.00
JUL =55.00 AUG =55.00 SEP =55.00 OCT =55.00 NOV =55.00 DEC =55.00

ZONE GROUP LOADS FOR OKLAHOMA CITY/WILL RODGERS, OK

SIMULATION PERIOD 1 JAN 1979 THRU 31 DEC 1979

NUMBER NAME MULTIPLIER

```

1      1  MECHANICAL ROOM          1
2      2  SMURF ROOM              1
3      3  RECEPTION                1
4      4  MUPPET ROOM             1
5      5  SHORT TALES ROOM        1
6      6  ATTIC                   1

```

ZONE	TOTAL CONVECTIVE HEATER LOAD	TOTAL RADIANT HEATER LOAD	TOTAL SENSIBLE COOLING LOAD	PEAK CONVECTIVE HEATER LOAD	PEAK RADIANT HEATER LOAD	PEAK SENSIBLE COOLING LOAD	MAX TEMP DEG. F	MIN TEMP DEG. F
	1000BTU	1000BTU	1000BTU	1000BTU/HR	1000BTU/HR	1000BTU/HR		
1	0.000E+00	0.000E+00	0.000E+00	0.000E+00	0.000E+00	0.000E+00	142.69	22.20
2	2.803E+04	0.000E+00	1.681E+04	3.821E+01	0.000E+00	2.598E+01	81.36	59.21
3	2.014E+04	0.000E+00	1.461E+04	2.583E+01	0.000E+00	2.118E+01	80.89	59.77
4	2.728E+04	0.000E+00	1.480E+04	3.677E+01	0.000E+00	2.238E+01	78.26	59.49
5	5.673E+04	0.000E+00	1.305E+04	7.270E+01	0.000E+00	3.114E+01	81.07	59.79
6	0.000E+00	0.000E+00	0.000E+00	0.000E+00	0.000E+00	0.000E+00	104.01	10.40
OGROUP:	1.322E+05	0.000E+00	5.927E+04	1.732E+02	0.000E+00	1.007E+02	142.69	10.40
OPEAK DATES (MO/DY/HR):				1/ 4/ 8	1/ 1/ 1	9/14/15	7/18/16	1/15/ 8
OTOTAL ITERATIONS =	34370							
DID NOT CONVERGE =	58							

1 US ARMY CORPS OF ENGINEERS -- BLAST VERSION 3.0 (ANSI FORTRAN 77) LEVEL 215 15 SEP 95 7:26: 3 PAGE 31

```

*****
**
**   A I R   H A N D L I N G   S Y S T E M   D E S C R I P T I O N
**
*****

```

SYSTEM NUMBER= 1, WATER LOOP SYSTEM
0 TYPE SYS = WATER LOOP HEAT PUMP NO. DISTINCT ZONES ON SYS. = 4

TOTAL SUPPLY FAN PRESSURE = 2.48914 IN-H2O
TOTAL RETURN FAN PRESSURE = 0.00000 IN-H2O
TOTAL EXHAUST FAN PRESSURE = 1.00396 IN-H2O

SUPPLY FAN EFFICIENCY = 0.70
RETURN FAN EFFICIENCY = 0.70
EXHAUST FAN EFFICIENCY = 0.70
0 MIXED AIR CONTROL = FIXED PERCENT
DESIRED MIXED AIR TEMPERATURE = 7.400E+01 DEG. F
0 HOT DECK CONTROL = FIXED SET POINT
HOT DECK THROTTLING RANGE = 1.80000 DEG. F
HOT DECK FIXED TEMPERATURE = 80.00000 DEG. F
0 HEATING COIL CAPACITY = 0.341E+07 1000BTU/HR
HEATING COIL ENERGY SUPPLY = HOT WATER
0 COLD DECK CONTROL = FIXED SET POINT
COLD DECK THROTTLING RANGE = 1.80000 DEG. F
COLD DECK FIXED TEMPERATURE = 60.00000 DEG. F

```

0
0 ZONE          ZONE          ZONE          ZONE          ZONE          ZONE          ZONE
  NUMBER    SUPPLY    EXHAUST    REHEAT    REHEAT    TSTAT BB    TSTAT BB    ZONE
            AIR VOL    AIR VOL    CAPCTY    ENERGY    CAPCTY    ENERGY    MULT
2      3.750E+02  0.000E+00  0.000E+00  HOT WATER  0.000E+00  HOT WATER    1.0
3      1.500E+02  0.000E+00  0.000E+00  HOT WATER  0.000E+00  HOT WATER    1.0
4      3.750E+02  0.000E+00  0.000E+00  HOT WATER  0.000E+00  HOT WATER    1.0
5      4.500E+02  0.000E+00  0.000E+00  HOT WATER  0.000E+00  HOT WATER    1.0
0 TOTAL DESIGN SUPPLY AIR VOLUME = 1.350E+03
1 US ARMY CORPS OF ENGINEERS -- BLAST VERSION 3.0 (ANSI FORTRAN 77)    LEVEL 215    15 SEP 95    7:26: 3    PAGE 32

```

```

*****
**
**          F A N   S Y S T E M   U N D E R H E A T I N G   /   U N D E R C O O L I N G   S U M M A R Y
**
*****

```

```

SYSTEM NUMBER=          1, WATER LOOP SYSTEM
SYSTEM LOCATION = 13967 OKLAHOMA CITY/WILL RODGERS, OK          SIMULATION PERIOD 1JAN1979 - 31DEC1979

```

```

*****
          F A N   S Y S T E M   U N D E R H E A T I N G
*****

```

MONTH	HEATING DEMAND FOR ZONE 1000BTU	HEATING PROVIDED BY FAN SYSTEM 1000BTU	HEATING NOT PROVIDED BY FAN SYSTEM 1000BTU	PEAK NOT PROVIDED BY FAN SYSTEM 1000BTU/HR	HOURS NOT PROVIDED (HOURS)
FOR ZONE 2					
JAN	5.232E+01	4.559E+01	6.731E+00	4.572E+00	5.000E+00
FEB	2.498E+01	2.389E+01	1.091E+00	6.017E-01	5.000E+00
MAR	2.766E+00	2.295E+00	4.712E-01	2.236E-01	3.000E+00
APR	4.596E+00	3.952E+00	6.441E-01	1.708E-01	5.000E+00
MAY	9.947E-01	8.140E-01	1.808E-01	1.808E-01	1.000E+00
JUN	9.511E-01	8.898E-01	6.130E-02	6.130E-02	1.000E+00
OCT	1.981E+00	1.892E+00	8.920E-02	5.062E-02	2.000E+00
NOV	2.805E+00	2.673E+00	1.317E-01	6.243E-02	3.000E+00
DEC	1.808E+00	1.664E+00	1.444E-01	7.517E-02	2.000E+00
TOTALS	9.320E+01	8.366E+01	9.545E+00	4.572E+00	2.700E+01

MONTH	HEATING DEMAND FOR ZONE 1000BTU	HEATING PROVIDED BY FAN SYSTEM 1000BTU	HEATING NOT PROVIDED BY FAN SYSTEM 1000BTU	PEAK NOT PROVIDED BY FAN SYSTEM 1000BTU/HR	HOURS NOT PROVIDED (HOURS)
FOR ZONE 3					
JAN	5.844E-01	4.978E-01	8.664E-02	8.664E-02	1.000E+00
FEB	3.012E+00	2.393E+00	6.192E-01	1.513E-01	5.000E+00
MAR	1.688E+00	1.454E+00	2.346E-01	1.212E-01	3.000E+00
APR	2.819E+00	2.503E+00	3.165E-01	1.100E-01	5.000E+00
MAY	1.844E+00	1.623E+00	2.208E-01	8.207E-02	3.000E+00
JUN	6.023E-01	5.636E-01	3.872E-02	3.872E-02	1.000E+00

OCT	6.306E-01	5.992E-01	3.139E-02	3.139E-02	1.000E+00
NOV	1.226E+00	1.129E+00	9.791E-02	6.315E-02	2.000E+00
DEC	1.163E+00	1.053E+00	1.096E-01	5.793E-02	2.000E+00

TOTALS	1.357E+01	1.181E+01	1.755E+00	1.513E-01	2.300E+01
--------	-----------	-----------	-----------	-----------	-----------

1 US ARMY CORPS OF ENGINEERS -- BLAST VERSION 3.0 (ANSI FORTRAN 77) LEVEL 215 15 SEP 95 7:26: 3 PAGE 33

MONTH	HEATING DEMAND FOR ZONE 1000BTU	HEATING PROVIDED BY FAN SYSTEM 1000BTU	HEATING NOT PROVIDED BY FAN SYSTEM 1000BTU	PEAK NOT PROVIDED BY FAN SYSTEM 1000BTU/HR	HOURS NOT PROVIDED (HOURS)
FOR ZONE	4				
JAN	4.519E+01	3.924E+01	5.945E+00	4.244E+00	3.000E+00
FEB	2.258E+01	2.146E+01	1.120E+00	5.118E-01	5.000E+00
MAR	5.098E+00	4.360E+00	7.374E-01	2.115E-01	6.000E+00
APR	6.813E+00	6.007E+00	8.062E-01	1.933E-01	8.000E+00
MAY	4.440E+00	4.058E+00	3.811E-01	1.283E-01	5.000E+00
JUN	9.358E-01	8.442E-01	9.161E-02	9.161E-02	1.000E+00
OCT	9.432E-01	8.988E-01	4.444E-02	4.444E-02	1.000E+00
NOV	9.378E-01	8.464E-01	9.140E-02	9.140E-02	1.000E+00
DEC	1.737E+00	1.580E+00	1.574E-01	1.172E-01	2.000E+00
TOTALS	8.868E+01	7.930E+01	9.375E+00	4.244E+00	3.200E+01

MONTH	HEATING DEMAND FOR ZONE 1000BTU	HEATING PROVIDED BY FAN SYSTEM 1000BTU	HEATING NOT PROVIDED BY FAN SYSTEM 1000BTU	PEAK NOT PROVIDED BY FAN SYSTEM 1000BTU/HR	HOURS NOT PROVIDED (HOURS)
FOR ZONE	5				
JAN	5.289E+02	4.781E+02	5.084E+01	1.453E+01	1.100E+01
FEB	9.811E+01	8.576E+01	1.235E+01	8.349E+00	6.000E+00
MAR	4.890E+01	4.739E+01	1.511E+00	1.166E+00	2.000E+00
APR	6.665E+00	5.994E+00	6.709E-01	2.489E-01	5.000E+00
MAY	4.343E+00	3.888E+00	4.556E-01	2.007E-01	3.000E+00
OCT	7.476E+00	7.175E+00	3.017E-01	8.070E-02	5.000E+00
NOV	1.486E+00	1.351E+00	1.344E-01	1.344E-01	1.000E+00
DEC	2.929E+00	2.523E+00	4.062E-01	2.069E-01	2.000E+00
TOTALS	6.988E+02	6.322E+02	6.667E+01	1.453E+01	3.500E+01

***** F A N S Y S T E M U N D E R C O O L I N G *****

FOR ZONE 2
NO UNDERCOOLING FOR THIS ZONE

FOR ZONE 3
NO UNDERCOOLING FOR THIS ZONE

FOR ZONE 4
 NO UNDERCOOLING FOR THIS ZONE
 1 US ARMY CORPS OF ENGINEERS -- BLAST VERSION 3.0 (ANSI FORTRAN 77) LEVEL 215 15 SEP 95 7:26: 3 PAGE 34

FOR ZONE 5
 NO UNDERCOOLING FOR THIS ZONE
 1 US ARMY CORPS OF ENGINEERS -- BLAST VERSION 3.0 (ANSI FORTRAN 77) LEVEL 215 15 SEP 95 7:26: 3 PAGE 35

 ** FAN SYSTEM OVERHEATING / OVERCOOLING SUMMARY **
 **

SYSTEM NUMBER= 1, WATER LOOP SYSTEM
 SYSTEM LOCATION = 13967 OKLAHOMA CITY/WILL RODGERS, OK SIMULATION PERIOD 1JAN1979 - 31DEC1979

FAN SYSTEM OVERHEATING

FOR ZONE 2
 NO OVERHEATING FOR THIS ZONE

FOR ZONE 3
 NO OVERHEATING FOR THIS ZONE

FOR ZONE 4
 NO OVERHEATING FOR THIS ZONE

FOR ZONE 5
 NO OVERHEATING FOR THIS ZONE

FAN SYSTEM OVERCOOLING

MONTH	COOLING DEMAND FOR ZONE 1000BTU	COOLING PROVIDED BY FAN SYSTEM 1000BTU	EXCESS COOLING PRO- VIDED BY FAN SYSTEM 1000BTU	EXCESS PEAK PRO- VIDED BY FAN SYSTEM 1000BTU/HR	HOURS EXCESS PROVIDED (HOURS)
-------	---------------------------------------	--	---	---	-------------------------------------

FOR ZONE 2					
APR	3.784E+00	3.841E+00	5.706E-02	5.706E-02	1.000E+00

TOTALS	3.784E+00	3.841E+00	5.706E-02	5.706E-02	1.000E+00

1 US ARMY CORPS OF ENGINEERS -- BLAST VERSION 3.0 (ANSI FORTRAN 77) LEVEL 215 15 SEP 95 7:26: 3 PAGE 36

MONTH	COOLING DEMAND FOR ZONE 1000BTU	COOLING PROVIDED BY FAN SYSTEM 1000BTU	EXCESS COOLING PROVIDED BY FAN SYSTEM 1000BTU	EXCESS PEAK PROVIDED BY FAN SYSTEM 1000BTU/HR	HOURS EXCESS PROVIDED (HOURS)
FOR ZONE 3					
JAN	3.902E+00	4.032E+00	1.298E-01	1.298E-01	1.000E+00
FEB	2.487E+00	2.610E+00	1.227E-01	1.227E-01	1.000E+00
MAY	1.067E+00	1.160E+00	9.241E-02	9.241E-02	1.000E+00
NOV	2.116E+00	2.179E+00	6.306E-02	6.306E-02	1.000E+00
DEC	2.375E+00	2.422E+00	4.741E-02	4.741E-02	1.000E+00
TOTALS	1.195E+01	1.240E+01	4.555E-01	1.298E-01	5.000E+00

MONTH	COOLING DEMAND FOR ZONE 1000BTU	COOLING PROVIDED BY FAN SYSTEM 1000BTU	EXCESS COOLING PROVIDED BY FAN SYSTEM 1000BTU	EXCESS PEAK PROVIDED BY FAN SYSTEM 1000BTU/HR	HOURS EXCESS PROVIDED (HOURS)
FOR ZONE 4					
FEB	3.417E+00	3.532E+00	1.152E-01	1.152E-01	1.000E+00
MAR	4.412E+00	4.523E+00	1.114E-01	1.114E-01	1.000E+00
OCT	3.115E+00	3.166E+00	5.124E-02	5.124E-02	1.000E+00
DEC	2.626E+00	2.675E+00	4.882E-02	4.882E-02	1.000E+00
TOTALS	1.357E+01	1.390E+01	3.267E-01	1.152E-01	4.000E+00

MONTH	COOLING DEMAND FOR ZONE 1000BTU	COOLING PROVIDED BY FAN SYSTEM 1000BTU	EXCESS COOLING PROVIDED BY FAN SYSTEM 1000BTU	EXCESS PEAK PROVIDED BY FAN SYSTEM 1000BTU/HR	HOURS EXCESS PROVIDED (HOURS)
FOR ZONE 5					
FEB	2.124E-01	4.993E-01	2.870E-01	2.870E-01	1.000E+00
JUN	1.760E+00	1.865E+00	1.043E-01	1.043E-01	1.000E+00
DEC	1.791E+00	1.873E+00	8.111E-02	8.111E-02	1.000E+00
TOTALS	3.764E+00	4.236E+00	4.724E-01	2.870E-01	3.000E+00

1 US ARMY CORPS OF ENGINEERS -- BLAST VERSION 3.0 (ANSI FORTRAN 77) LEVEL 215 15 SEP 95 7:26: 3 PAGE 37

 ** FAN SYSTEM HEATING / COOLING WITHOUT DEMAND SUMMARY **

SYSTEM NUMBER= 1, WATER LOOP SYSTEM
 SYSTEM LOCATION = 13967 OKLAHOMA CITY/WILL RODGERS, OK SIMULATION PERIOD 1JAN1979 - 31DEC1979

***** HEATING WITHOUT DEMAND *****

FOR ZONE 2
NO HEATING WITHOUT DEMAND FOR THIS ZONE

FOR ZONE 3
NO HEATING WITHOUT DEMAND FOR THIS ZONE

FOR ZONE 4
NO HEATING WITHOUT DEMAND FOR THIS ZONE

FOR ZONE 5
NO HEATING WITHOUT DEMAND FOR THIS ZONE

***** C O O L I N G W I T H O U T D E M A N D *****

FOR ZONE 2
NO COOLING WITHOUT DEMAND FOR THIS ZONE

FOR ZONE 3
NO COOLING WITHOUT DEMAND FOR THIS ZONE

FOR ZONE 4
NO COOLING WITHOUT DEMAND FOR THIS ZONE

1 US ARMY CORPS OF ENGINEERS -- BLAST VERSION 3.0 (ANSI FORTRAN 77) LEVEL 215 15 SEP 95 7:26: 3 PAGE 38

MONTH	COOLING DEMAND FOR ZONE 1000BTU	COOLING PROVIDED BY FAN SYSTEM 1000BTU	EXCESS COOLING PRO- VIDED BY FAN SYSTEM 1000BTU	EXCESS PEAK PRO- VIDED BY FAN SYSTEM 1000BTU/HR	HOURS EXCESS PROVIDED (HOURS)
FOR ZONE 5					
APR	0.000E+00	7.217E-02	7.217E-02	7.217E-02	1.000E+00
MAY	0.000E+00	3.265E-02	3.265E-02	3.265E-02	1.000E+00

TOTALS	0.000E+00	1.048E-01	1.048E-01	7.217E-02	2.000E+00
1 US ARMY CORPS OF ENGINEERS -- BLAST VERSION 3.0 (ANSI FORTRAN 77) LEVEL 215 15 SEP 95 7:26: 3 PAGE 39					

**
** R E V I E W S U M M A R Y R E P O R T **
**

1 BUILDING WITH 6 ZONES
1 SYSTEM
0 PLANTS

SIMULATION PERIOD = 1 JAN 1979 - 31 DEC 1979
LOCATION = OKLAHOMA CITY/WILL RODGERS, OK
HEATING DEGREE DAYS = 3869.0

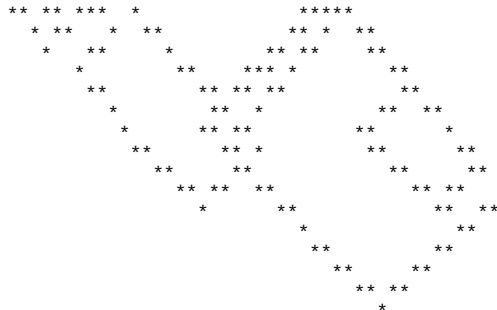

 *** BUILDING ENVELOPE DATA ***

NOTE ** SURFACES IN ZONES DESIGNATED AS ATTIC OR CRAWLSPACE ARE NOT INCLUDED

*NORTH= 0.
 EAST= 90.0

	AREA (FT**2)	U (B/H*F**2*R)	AZIMUTH* (DEGREES)	TILT (DEGREES)	PER CENT GLAZING
ROOF	4850.00	0.222	*****	0.0	0.0
ROOF1	4850.00	0.222	*****	0.0	
EXTERIOR WALL	1100.84	0.061	135.0	90.0	0.4
WALL1	1051.34	0.045	135.0	90.0	
DOOR1	21.00	0.568	135.0	90.0	
SINGLE PANE HW WINDOW	4.00	1.115	135.0	90.0	
METAL INSULATED DOOR	24.50	0.138	135.0	90.0	
EXTERIOR WALL	1417.21	0.084	45.0	90.0	0.9
WALL1	1326.89	0.045	45.0	90.0	
DOOR1	77.00	0.568	45.0	90.0	
SINGLE PANE HW WINDOW	13.32	1.115	45.0	90.0	
EXTERIOR WALL	1139.92	0.072	225.0	90.0	2.5
WALL1	1111.92	0.045	225.0	90.0	
SINGLE PANE HW WINDOW	28.00	1.115	225.0	90.0	
WALL TO UNCOOLED SPACE	143.04	0.046	45.0	90.0	0.0
WALL1	143.04	0.046	45.0	90.0	
WALL TO UNCOOLED SPACE	91.36	0.046	135.0	90.0	0.0
WALL1	91.36	0.046	135.0	90.0	
EXTERIOR WALL	78.00	0.390	135.0	90.0	0.0
WALL2	78.00	0.390	135.0	90.0	
EXTERIOR WALL	1178.71	0.085	315.0	90.0	2.4
WALL1	1066.71	0.045	315.0	90.0	

DOOR1	21.00	0.568	315.0	90.0	
SINGLE PANE HW WINDOW	28.00	1.115	315.0	90.0	
METAL INSULATED DOOR	63.00	0.138	315.0	90.0	
EXTERIOR WALL	275.21	0.480	225.0	90.0	5.3
WALL2	239.51	0.390	225.0	90.0	
SINGLE PANE HW WINDOW	14.70	1.115	225.0	90.0	
GLASS DOOR	21.00	1.059	225.0	90.0	

1 US ARMY CORPS OF ENGINEERS -- BLAST VERSION 3.0 (ANSI FORTRAN 77) LEVEL 215 15 SEP 95 7:26: 3 PAGE 42

 *** BUILDING ENVELOPE DATA ***

NOTE ** SURFACES IN ZONES DESIGNATED AS ATTIC OR CRAWLSPACE ARE NOT INCLUDED

	AREA (FT**2)	U (B/H**F**2*R)	AZIMUTH* (DEGREES)	TILT (DEGREES)	PER CENT GLAZING	*NORTH= 0. EAST= 90.0
SLAB ON GRADE FLOOR	4866.69	0.258	****	180.0	0.0	
FLOOR1	4866.69	0.258	****	180.0		
	=====	=====			=====	
	15140.98	0.102	(OVERALL WALL AVERAGE)		1.7 PERCENT OF TOTAL WALL AREA	
		0.190	(BUILDING OVERALL AVERAGE)		0.9 PERCENT OF TOTAL FLOOR AREA	

FLOOR AREA OF BUILDING	=	9694.21	FT**2	
APPROX EXTERIOR SURFACE AREA	=	15140.98	FT**2	
APPROXIMATE VOLUME	=	63063.42	FT**3	
APPROX VOLUME / FLOOR AREA	=	6.5	FT (APPROXIMATE BUILDING WALL HEIGHT)	

1 US ARMY CORPS OF ENGINEERS -- BLAST VERSION 3.0 (ANSI FORTRAN 77) LEVEL 215 15 SEP 95 7:26: 3 PAGE 43

 *** SURFACE CONSTRUCTIONS ***

	U WITHOUT FILM COEFF (B/H**F**2*R)
WALL1	0.047
A7 - 4 IN FACE BRICK	2.312
B1 - AIRSPACE RESISTANCE	1.099
PLASTER - GYPSUM LWA 5 / 8 IN	2.495
INS - MINERAL FIBER FIBROUS 6 IN	0.053
PLASTER - GYPSUM LWA 5 / 8 IN	2.495
DOOR1	1.098
METAL - GALVANIZED STEEL 1 / 16 IN	5038.461
B1 - AIRSPACE RESISTANCE	1.099

METAL - GALVANIZED STEEL 1 / 16 IN	5038.461				
FLOOR1	0.313				
CONCRETE - DRIED SAND AND GRAVEL 6 IN	1.500				
BUILDING MEMBRANE - MOPPED FELT	8.333				
C5 - 4 IN HW CONCRETE	3.003				
FINISH FLOORING - CARPET FIBROUS PAD	0.481				
CEILING1	0.048				
PLASTER - GYPSUM LWA 5 / 8 IN	2.495				
E4 - CEILING AIRSPACE	1.000				
INS - MINERAL FIBER FIBROUS 6 IN	0.053				
PLASTER - GYPSUM LWA 5 / 8 IN	2.495				
SINGLE PANE HW WINDOW	21.186				
GLASS - CLEAR PLATE 1 / 4 IN	21.186				
WALL2	0.584				
PLASTER - GYPSUM LWA 5 / 8 IN	2.495				
B1 - AIRSPACE RESISTANCE	1.099				
PLASTER - GYPSUM LWA 5 / 8 IN	2.495				
SOLID WOOD DOOR	0.419				
B10 - 2 IN WOOD	0.419				
GLASS DOOR	10.593				
GLASS - CLEAR PLATE 1 / 2 IN	10.593				
METAL INSULATED DOOR	0.157				
METAL - GALVANIZED STEEL 1 / 16 IN	5038.461				
INS - EXPANDED POLYURETHANE R11 1 IN	0.157				
METAL - GALVANIZED STEEL 1 / 16 IN	5038.461				
1 US ARMY CORPS OF ENGINEERS -- BLAST VERSION 3.0 (ANSI FORTRAN 77)		LEVEL 215	15 SEP 95	7:26: 3	PAGE 44

 *** SURFACE CONSTRUCTIONS ***

U
 WITHOUT FILM COEFF
 (B/H**F**2*R)

FLOOR2	0.048				
PLASTER - GYPSUM LWA 5 / 8 IN	2.495				
E4 - CEILING AIRSPACE	1.000				
INS - MINERAL FIBER FIBROUS 6 IN	0.053				
PLASTER - GYPSUM LWA 5 / 8 IN	2.495				
ROOF1	0.273				
ROOFING - BUILT UP ROOFING - 3 / 8 IN	3.003				
C14 - 4 IN LW CONCRETE	0.300				
1 US ARMY CORPS OF ENGINEERS -- BLAST VERSION 3.0 (ANSI FORTRAN 77)		LEVEL 215	15 SEP 95	7:26: 3	PAGE 45

 *** FAN SYSTEM DATA ***

SYSTEM 1 WATER LOOP HEAT PUMP WATER LOOP SYSTEM
 SERVING ZONES: 2, 3, 4, 5

MIXED AIR CONTROL = FIXED PERCENT	DESIRED MIXED AIR TEMP = 74 DEG. F
COLD DECK CONTROL = FIXED SET POINT	COLD DECK FIXED TEMP = 60 DEG. F
HOT DECK CONTROL = FIXED SET POINT	HOT DECK FIXED TEMP = 80 DEG. F
SYSTEM OPERATION = FAN OPERATION, 1JAN THRU 31DEC	EXHAUST FAN OPERATION = FAN OPERATION, 1JAN THRU 31DEC
PREHEAT COIL OPERATION =ON,01JAN THRU 31DEC	HEATING COIL OPERATION = OFF, 1JAN THRU 31DEC
COOLING COIL OPERATION = OFF, 1JAN THRU 31DEC	HUMIDIFIER OPERATION =ON,01JAN THRU 31DEC
TSTAT BASEBOARD HEAT OPERATION = OFF, 1JAN THRU 31DEC	HEAT RECOVERY OPERATION = OFF, 1JAN THRU 31DEC
MINIMUM VENTILATION SCHEDULE = FAN OPERATION, 1JAN THRU 31DEC	
MAXIMUM VENTILATION SCHEDULE = FAN OPERATION, 1JAN THRU 31DEC	
SYSTEM ELECTRICAL DEMAND SCHEDULE = ON, 1JAN THRU 31DEC	
EVAPORATIVE COOLER OPERATION =ON,01JAN THRU 31DEC	HEAT PUMP BACKUP HEAT OPERATION =ON,01JAN THRU 31DEC
HEAT PUMP COOLING OPERATION =ON,01JAN THRU 31DEC	HEAT PUMP HEATING OPERATION =ON,01JAN THRU 31DEC
WLHPS STORAGE TANK OPERATION = OFF, 1JAN THRU 31DEC	
WLHPS VENTILATION SYSTEM OPERATIO = FAN OPERATION, 1JAN THRU 31DEC	
WLHPS LOOP CONTROL SCHEDULE = OFF, 1JAN THRU 31DEC	
VAV MINIMUM AIR FRACTION SCHEDULE =ON,01JAN THRU 31DEC	

ZONE	SUPPLY AIR VOLUME FT**3/MIN	MINIMUM AIR FRACTION	EXHAUST AIR VOLUME FT**3/MIN	REHEAT CAPACITY 1000BTU	BASEBOARD HEAT CAPACITY 1000BTU	RECOOL CAPACITY 1000BTU	ZONE MULTIPLIER
2	3.750E+02	0.00	0.000E+00	0.000E+00	0.000E+00	0.000E+00	1
3	1.500E+02	0.00	0.000E+00	0.000E+00	0.000E+00	0.000E+00	1
4	3.750E+02	0.00	0.000E+00	0.000E+00	0.000E+00	0.000E+00	1
5	4.500E+02	0.00	0.000E+00	0.000E+00	0.000E+00	0.000E+00	1

***** NO PLANTS WERE SIMULATED *****

1 US ARMY CORPS OF ENGINEERS -- BLAST VERSION 3.0 (ANSI FORTRAN 77) LEVEL 215 15 SEP 95 7:26: 3 PAGE 46

 *** SCHEDULED LOADS ***

ZONE NUMBER	FROM	THRU	SCHEDULE	DESIGN PEAK LOAD PER FT**2	# HOURS PER WEEK	AVERAGE LOAD WHEN LOAD SCHEDULED
1	US ARMY	CORPS OF ENGINEERS	-- BLAST VERSION 3.0 (ANSI FORTRAN 77)	LEVEL 215	15 SEP 95	7:26: 3 PAGE 47

 *** SCHEDULED LOADS ***

ZONE NUMBER	FROM	THRU	SCHEDULE	DESIGN PEAK LOAD		DESIGN PEAK LOAD PER FT**2	# HOURS PER WEEK	AVERAGE LOAD WHEN LOAD SCHEDULED
PEOPLE:								
2	1JAN	31DEC	FAN OPERATION	25.0	PEOPLE	2.402E-02	45.0	2.500E+01 PEOPLE
3	1JAN	31DEC	FAN OPERATION	10.0	PEOPLE	1.939E-02	45.0	1.000E+01 PEOPLE
4	1JAN	31DEC	FAN OPERATION	25.0	PEOPLE	1.959E-02	45.0	2.500E+01 PEOPLE
5	1JAN	31DEC	FAN OPERATION	30.0	PEOPLE	1.640E-02	45.0	3.000E+01 PEOPLE
LIGHTS:								
2	1JAN	31DEC	OFFICE LIGHTING	1.70	1000BTU	1.633E-03	168.	5.960E-01 1000BTU
3	1JAN	31DEC	OFFICE LIGHTING	0.850	1000BTU	1.649E-03	168.	2.980E-01 1000BTU
4	1JAN	31DEC	OFFICE LIGHTING	1.87	1000BTU	1.465E-03	168.	6.556E-01 1000BTU
5	1JAN	31DEC	OFFICE LIGHTING	2.04	1000BTU	1.115E-03	168.	7.152E-01 1000BTU

NO ELECT EQUIP:

NO GAS EQUIP:

OTHER EQUIP LOADS:

NEGATIVE AMOUNTS DENOTE LOSS, POSITIVE AMOUNTS DENOTE GAIN

OTHER EQUIPMENT LOADS ARE NOT INCLUDED IN ENERGY BUDGET FIGURES.

1	1JAN	31DEC	OFFICE OCCUPANCY	13.7	1000BTU	6.685E-02	60.0	9.896E+00 1000BTU
2	1JAN	31DEC	OFFICE OCCUPANCY	8.50	1000BTU	8.165E-03	60.0	6.163E+00 1000BTU
3	1JAN	31DEC	OFFICE OCCUPANCY	5.10	1000BTU	9.891E-03	60.0	3.698E+00 1000BTU
4	1JAN	31DEC	OFFICE OCCUPANCY	8.50	1000BTU	6.659E-03	60.0	6.163E+00 1000BTU
5	1JAN	31DEC	OFFICE OCCUPANCY	5.10	1000BTU	2.788E-03	60.0	3.698E+00 1000BTU

 *** INFILTRATION AND VENTILATION ***

NUMBER	FROM	THRU	-- BLAST VERSION 3.0 (ANSI FORTRAN 77)	OCCUPIED		UNOCCUPIED		SPECIFIED PEAK FLOW
				MAX	MIN	MAX	MIN	
1	US ARMY	CORPS OF ENGINEERS		LEVEL 215	15 SEP 95		7:26: 3	PAGE 48

 *** INFILTRATION AND VENTILATION ***

NUMBER	FROM	THRU	SCHEDULE	OCCUPIED		UNOCCUPIED		SPECIFIED PEAK FLOW
				MAX	MIN	MAX	MIN	
INFILTRATION:								
1	1JAN	31DEC	CONSTANT	AIR CH/HR	*****	*****	3.9	0.7
				FT**3/MIN	*****	*****	1.1E+02	1.9E+01
				MO/DA/HR	*****	*****	3/ 2/15	6/19/ 6
2	1JAN	31DEC	CONSTANT	AIR CH/HR	3.4	0.6	3.4	0.6
								1.0

			FT**3/MIN	4.7E+02	8.7E+01	4.7E+02	8.5E+01		1.4E+02
			MO/DA/HR	3/ 2/ 9	11/ 1/15	3/ 2/ 6	8/14/ 5		
3	1JAN 31DEC	CONSTANT	AIR CH/HR	3.7	0.7	3.7	0.7		1.1
			FT**3/MIN	2.6E+02	4.8E+01	2.6E+02	4.7E+01		7.5E+01
			MO/DA/HR	3/ 2/ 9	11/ 1/15	3/ 2/ 6	8/14/ 5		
4	1JAN 31DEC	CONSTANT	AIR CH/HR	2.5	0.5	2.5	0.4		0.7
			FT**3/MIN	4.2E+02	8.0E+01	4.2E+02	7.5E+01		1.2E+02
			MO/DA/HR	3/ 2/ 9	11/ 1/15	3/ 2/ 6	6/ 6/24		
5	1JAN 31DEC	CONSTANT	AIR CH/HR	3.4	0.7	3.4	0.6		1.0
			FT**3/MIN	8.4E+02	1.6E+02	8.4E+02	1.5E+02		2.5E+02
			MO/DA/HR	3/ 2/ 9	11/ 1/15	3/ 2/ 6	8/14/ 5		
6	1JAN 31DEC	CONSTANT	AIR CH/HR	*****	*****	3.0	0.6		1.0
			FT**3/MIN	*****	*****	1.2E+03	2.5E+02		4.0E+02
			MO/DA/HR	*****	*****	3/ 2/ 5	11/ 1/15		

INFILTRATION HEAT LOSS = 93981.19 1000BTU, 71.1 PERCENT OF THE HEATING LOAD
INFILTRATION HEAT GAIN = 11243.96 1000BTU, 19.0 PERCENT OF THE COOLING LOAD

NO NATURAL VENTILATION:

1 US ARMY CORPS OF ENGINEERS -- BLAST VERSION 3.0 (ANSI FORTRAN 77) LEVEL 215 15 SEP 95 7:26: 3 PAGE 49

*** MECHANICAL VENTILATION ***

NUMBER	FROM THRU	OCCUPIED		UNOCCUPIED		PEAK FLOW	
		MAX	MIN	MAX	MIN		
OUTSIDE AIR:							
SYS 1	1JAN THRU 31DEC, FAN OPERATION	FT**3/MIN	1.4E+03	0.0E+00	1.4E+03	0.0E+00	1.4E+03
		MO/DA/HR	1/ 2/ 9	1/ 2/ 7	1/ 3/19	1/ 1/ 1	

*** SPACE TEMPERATURES DEG. F ***

ZONE NUMBER	CONTROLS	HEATING				COOLING				NO HEATING OR COOLING				
		OCCUPIED		UNOCCUPIED		OCCUPIED		UNOCCUPIED		OCCUPIED		UNOCCUPIED		
		MAX	MIN	MAX	MIN	MAX	MIN	MAX	MIN	MAX	MIN	MAX	MIN	
1	*****NO CONTROLS*****	*****	*****	*****	*****	*****	*****	*****	*****	*****	*****	*****	142.69	22.20
2	DC	70.30	68.01	72.26	59.21	73.12	69.99	81.36	72.62	73.00	68.25	81.30	59.42	
3	DC	72.20	67.96	74.25	59.77	73.14	67.61	80.86	71.20	72.90	68.12	80.89	59.83	
4	DC	70.44	68.87	72.29	59.49	73.34	70.80	73.25	73.14	73.31	69.11	78.26	59.62	

5 DC 70.52 68.80 72.07 59.79 73.02 71.15 81.04 72.84 73.00 68.79 81.07 60.03
 6 *****NO CONTROLS***** ***** 104.01 10.40
 1 US ARMY CORPS OF ENGINEERS -- BLAST VERSION 3.0 (ANSI FORTRAN 77) LEVEL 215 15 SEP 95 7:26: 3 PAGE 50

 *** ZONES ENERGY BUDGET ***

CATEGORY CODE = 74014
 FACILITY CATEGORY = Community Facilities (MWR)
 LOCATION = OKLAHOMA CITY/WILL RODGERS, OK
 PROJECT TITLE = DAYCARE CENTER

SIMULATION PERIOD = 1 JAN 1979 - 31 DEC 1979
 BUDGET REGION = 4
 HEATING DEGREE DAYS = 3869.0
 COOLING DEGREE DAYS = 1820.9
 REQUIRED ENERGY BUDGET= 45

ZONE LOAD

NUMBER	TOTAL HEAT 1000BTU	TOTAL COOL 1000BTU	TOTAL ELECT 1000BTU	TOTAL GAS 1000BTU	INFIL LOSS 1000BTU	INFIL GAIN 1000BTU	TOTAL AREA FT**2	ENERGY BUDGET 1000BTU / FT**2
1	0.000E+00	0.000E+00	0.000E+00	0.000E+00	0.000E+00	0.000E+00	2.042E+02	0.000E+00
2	2.803E+04	1.681E+04	5.071E+03	0.000E+00	2.144E+04	2.735E+03	1.041E+03	4.795E+01
3	2.014E+04	1.461E+04	2.536E+03	0.000E+00	1.195E+04	1.908E+03	5.156E+02	7.232E+01
4	2.728E+04	1.480E+04	5.579E+03	0.000E+00	1.895E+04	2.246E+03	1.276E+03	3.733E+01
5	5.673E+04	1.305E+04	6.086E+03	0.000E+00	4.164E+04	4.355E+03	1.829E+03	4.147E+01
6	0.000E+00	0.000E+00	0.000E+00	0.000E+00	0.000E+00	0.000E+00	4.828E+03	0.000E+00
	=====	=====	=====	=====	=====	=====	=====	=====
TOTAL	1.322E+05	5.927E+04	1.927E+04	0.000E+00	9.398E+04	1.124E+04	9.694E+03	

ENERGY BUDGET FOR ALL ZONES = 2.174E+01 1000BTU / FT**2

*** ZONE ENERGY BUDGETS DO NOT INCLUDE FAN SYSTEMS OR EQUIPMENT INEFFICIENCIES
 1 US ARMY CORPS OF ENGINEERS -- BLAST VERSION 3.0 (ANSI FORTRAN 77) LEVEL 215 15 SEP 95 7:26: 3 PAGE 51

 *** SYSTEMS ENERGY BUDGET ***

CATEGORY CODE = 74014
 FACILITY CATEGORY = Community Facilities (MWR)
 LOCATION = OKLAHOMA CITY/WILL RODGERS, OK
 PROJECT TITLE = DAYCARE CENTER

SIMULATION PERIOD = 1 JAN 1979 - 31 DEC 1979
 BUDGET REGION = 4
 HEATING DEGREE DAYS = 3869.0
 COOLING DEGREE DAYS = 1820.9
 REQUIRED ENERGY BUDGET= 45

SYSTEM LOADS

NUMBER	UNDER HEAT 1000BTU HOURS	UNDER COOL 1000BTU HOURS	OVER HEAT 1000BTU HOURS	OVER COOL 1000BTU HOURS	HEAT W/O DMD 1000BTU HOURS	COOL W/O DMD 1000BTU HOURS
1	8.734E+01 (117)	0.000E+00 (0)	0.000E+00 (0)	1.312E+00 (13)	0.000E+00 (0)	1.048E-01 (2)

TOTAL =====
 8.734E+01 (117) =====
 0.000E+00 (0) =====
 0.000E+00 (0) =====
 1.312E+00 (13) =====
 0.000E+00 (0) =====
 1.048E-01 (0)

NUMBER	TOTAL HEAT 1000BTU	TOTAL COOL 1000BTU	TOTAL ELECT 1000BTU	TOTAL GAS 1000BTU	TOTAL AREA FT**2	ENERGY BUDGET 1000BTU / FT**2
1	1.152E+05 =====	1.544E+05 =====	1.071E+05 =====	0.000E+00 =====	4.663E+03 =====	8.081E+01
TOTAL	1.152E+05	1.544E+05	1.071E+05	0.000E+00	4.663E+03	

ENERGY BUDGET FOR ALL SYSTEMS = 8.081E+01 1000BTU / FT**2

*** ENERGY BUDGET DOES NOT INCLUDE UNDER/OVER/W.O. DEMAND HEATING/COOLING ITEMS

***** NO PLANT INFORMATION AVAILABLE *****

1 US ARMY CORPS OF ENGINEERS -- BLAST VERSION 3.0 (ANSI FORTRAN 77) LEVEL 215 15 SEP 95 7:26: 3 PAGE 52

PSYCHROMETRIC ERROR SUMMARY
 0 CUMULATIVE FOR ENTIRE RUN

ROUTINE	NUMBER OF ERRORS
PSYDPT	0
PSYRHT	0
PSYTWD	0
PSYVTW	0
PSYWDP	0
PSYWTH	0
PSYWTP	0
PSYWTR	0
SATUPT	0
SATUTH	0
SATUTP	0

9 boreholes in a square, B/H = 0.20

G-function file: g1020.gfc

Active borehole length, H (ft) 200.0
 Borehole radius, RADb (in) 3.000
 Thermal conductivity, K (Btu/(hr*ft*F)) 1.40
 Volumetric heat capacity of ground, Cground (Btu/ft^3F) 35.00
 Volumetric heat capacity of fluid, Cfluid (Btu/ft^3F) 62.40
 Undisturbed ground temp., Tom (degrees F) 61.0
 Borehole thermal resistance, Rb (F/Btu/ft*hr) 0.173
 Flow rate, Mdot (gal/min) 40.00
 Density of fluid, RHO (lb/ft^3) 62.400

Month	Monthly Loads Heating(Btu)	Cooling(Btu)
January	30155038.000	298507.688
February	23015550.000	170298.000
March	17300904.000	1327069.000
April	4532527.000	7275339.000
May	1497159.000	14541550.000
June	477409.813	29056542.000
July	73662.438	32583602.000
August	13800.280	35829912.000
September	968979.875	21422610.000
October	4042425.000	9276274.000
November	12415815.000	1625848.000
December	23406112.000	369158.594

Time (months)	Q (Btu/hr*ft)	Power (kW)	Tf (F)	Tin (F)	Tout (F)
1	22.04	0.00	61.00	60.01	61.99
2	18.26	0.00	48.45	47.63	49.28
3	11.54	0.00	49.79	49.27	50.31
4	-2.11	0.00	53.27	53.37	53.18
5	-9.60	0.00	61.01	61.44	60.58
6	-21.86	0.00	65.68	66.67	64.70
7	-24.46	0.00	73.16	74.26	72.06
8	-27.03	0.00	75.39	76.60	74.17
9	-16.04	0.00	77.40	78.12	76.68
10	-3.92	0.00	71.65	71.82	71.47
11	8.22	0.00	64.75	64.38	65.12
12	16.86	0.00	57.46	56.71	58.22
1	21.69	0.00	51.95	50.97	52.92
2	18.27	0.00	48.56	47.74	49.39
3	11.55	0.00	49.95	49.43	50.47
4	-2.11	0.00	53.53	53.63	53.44
5	-9.61	0.00	61.34	61.77	60.91
6	-21.87	0.00	66.04	67.03	65.06
7	-24.47	0.00	73.47	74.57	72.37

8	-27.06	0.00	75.64	76.86	74.43
9	-16.05	0.00	77.63	78.36	76.91
10	-3.92	0.00	71.85	72.03	71.67
11	8.23	0.00	64.93	64.56	65.30
12	16.87	0.00	57.68	56.92	58.44
1	21.69	0.00	52.21	51.24	53.19
2	18.28	0.00	48.87	48.05	49.69
3	11.55	0.00	50.27	49.75	50.79
4	-2.11	0.00	53.84	53.93	53.74
5	-9.61	0.00	61.61	62.04	61.17
6	-21.88	0.00	66.27	67.25	65.28
7	-24.48	0.00	73.69	74.79	72.59
8	-27.07	0.00	75.85	77.07	74.64
9	-16.06	0.00	77.84	78.56	77.12
10	-3.92	0.00	72.04	72.22	71.87
11	8.23	0.00	65.09	64.72	65.46
12	16.87	0.00	57.82	57.06	58.58
1	21.70	0.00	52.33	51.36	53.31
2	18.28	0.00	48.98	48.16	49.80
3	11.55	0.00	50.39	49.87	50.91
4	-2.11	0.00	53.97	54.06	53.87
5	-9.61	0.00	61.76	62.19	61.33
6	-21.88	0.00	66.44	67.42	65.45
7	-24.49	0.00	73.87	74.97	72.77
8	-27.09	0.00	76.04	77.26	74.82
9	-16.06	0.00	78.02	78.75	77.30
10	-3.92	0.00	72.20	72.38	72.03
11	8.23	0.00	65.24	64.87	65.61
12	16.88	0.00	57.97	57.21	58.72
1	21.71	0.00	52.47	51.50	53.45
2	18.29	0.00	49.12	48.29	49.94
3	11.56	0.00	50.52	50.00	51.04
4	-2.11	0.00	54.09	54.19	54.00
5	-9.61	0.00	61.88	62.31	61.45
6	-21.88	0.00	66.55	67.54	65.57
7	-24.49	0.00	73.99	75.09	72.88
8	-27.10	0.00	76.16	77.37	74.94
9	-16.06	0.00	78.14	78.86	77.42
10	-3.92	0.00	72.32	72.50	72.14
11	8.24	0.00	65.36	64.99	65.73
12	16.88	0.00	58.08	57.32	58.84
1	21.72	0.00	52.59	51.61	53.56
2	18.29	0.00	49.22	48.40	50.04
3	11.56	0.00	50.62	50.10	51.14
4	-2.11	0.00	54.19	54.29	54.10
5	-9.61	0.00	61.98	62.41	61.55
6	-21.89	0.00	66.65	67.64	65.67
7	-24.50	0.00	74.09	75.19	72.99
8	-27.10	0.00	76.26	77.48	75.04
9	-16.07	0.00	78.24	78.96	77.51
10	-3.92	0.00	72.41	72.59	72.24
11	8.24	0.00	65.45	65.08	65.82
12	16.88	0.00	58.17	57.41	58.92
1	21.72	0.00	52.67	51.69	53.65
2	18.30	0.00	49.31	48.48	50.13
3	11.56	0.00	50.71	50.19	51.23
4	-2.11	0.00	54.28	54.38	54.19
5	-9.61	0.00	62.07	62.50	61.64
6	-21.89	0.00	66.74	67.73	65.76
7	-24.50	0.00	74.18	75.28	73.08
8	-27.10	0.00	76.34	77.56	75.13

9	-16.07	0.00	78.32	79.04	77.60
10	-3.93	0.00	72.49	72.67	72.32
11	8.24	0.00	65.53	65.16	65.90
12	16.88	0.00	58.25	57.49	59.00
1	21.73	0.00	52.75	51.77	53.72
2	18.30	0.00	49.38	48.56	50.21
3	11.56	0.00	50.78	50.26	51.30
4	-2.12	0.00	54.36	54.45	54.26
5	-9.61	0.00	62.15	62.58	61.71
6	-21.89	0.00	66.82	67.80	65.83
7	-24.51	0.00	74.25	75.35	73.15
8	-27.11	0.00	76.42	77.64	75.20
9	-16.07	0.00	78.40	79.12	77.67
10	-3.92	0.00	72.57	72.74	72.39
11	8.24	0.00	65.60	65.23	65.97
12	16.89	0.00	58.31	57.55	59.07
1	21.73	0.00	52.81	51.84	53.79
2	18.30	0.00	49.45	48.62	50.27
3	11.56	0.00	50.85	50.33	51.37
4	-2.12	0.00	54.42	54.52	54.33
5	-9.61	0.00	62.21	62.64	61.78
6	-21.90	0.00	66.89	67.87	65.90
7	-24.51	0.00	74.32	75.43	73.22
8	-27.12	0.00	76.49	77.71	75.27
9	-16.07	0.00	78.47	79.19	77.75
10	-3.93	0.00	72.63	72.81	72.46
11	8.25	0.00	65.66	65.29	66.04
12	16.89	0.00	58.37	57.61	59.13
1	21.73	0.00	52.87	51.89	53.84
2	18.30	0.00	49.50	48.67	50.32
3	11.56	0.00	50.90	50.38	51.42
4	-2.12	0.00	54.48	54.57	54.38
5	-9.61	0.00	62.26	62.70	61.83
6	-21.90	0.00	66.94	67.92	65.96
7	-24.52	0.00	74.38	75.48	73.28
8	-27.12	0.00	76.55	77.76	75.33
9	-16.08	0.00	78.52	79.25	77.80
10	-3.93	0.00	72.69	72.86	72.51
11	8.25	0.00	65.71	65.34	66.08
12	16.89	0.00	58.42	57.66	59.18